

CHEVROLET MUNICIPAL VEHICLES TECHNICAL MANUAL



2012

About This Publication

- Care must be taken during customer installation of equipment and wiring to ensure that all holes drilled in the body are corrosion protected, properly sealed and that vehicle wiring harnesses, piping or other components have not been displaced or damaged. Aftermarket equipment installers must be mindful of applicable Federal Motor Vehicle Safety Standards. This information can be obtained directly from the National Highway Traffic Safety Administration.
- These vehicles are equipped with an air bag system. The air bag system in your police vehicle includes side curtain air bags. Customer installed equipment such as security barriers behind the front seats should not be mounted so that the barrier ends are within the side air bag deployment zones. The sensors and other components for the air bag system must not be relocated to accommodate the installation of customer furnished equipment; please refer to the service manual for sensor and other component locations. For information concerning instrument panel top pad mounted equipment and air bag system deployment zones, see the air bag information section in this catalog.
- This catalog is not updated during the model year and should not be used for ordering purposes. It is intended as a source of basic information. All illustrations and specifications in this literature are based on the latest product information available at the time of publication. General Motors reserves the right to make changes at any time without notice. For further details, consult your local dealer.
- A note about vehicle alterations by independent suppliers: This catalog shows pictures of vehicles that have been altered or upfitted with equipment or components supplied to Chevrolet or its dealers by independent suppliers. Chevrolet is not responsible for the safety or quality of design features, materials or workmanship of any alterations by a supplier.

**LAW ENFORCEMENT PRODUCT COUNCIL
DISTRICT SALES MANAGERS AND FLEET SERVICE MANAGERS**

**CAPRICE POLICE PATROL CAR (OPTION 9C1)
CAPRICE DETECTIVE CAR (OPTION 9C3)**

**IMPALA POLICE PATROL CAR (OPTION 9C1)
IMPALA UNDERCOVER CAR (OPTION 9C3)**

**TAHOE POLICE PATROL SUV (OPTION PPV)
TAHOE SPECIAL SERVICE SUV (OPTION 5W4)**

TAHOE HYBRID MUNICIPAL SUV (OPTION 1HY)

EXPRESS TRANSPORT VAN (OPTION 1LS AND 2LS)

SUBURBAN COMMERCIAL FLEET SUV (OPTION 1FL)

**SILVERADO 1500 CREW CAB PICKUP WORK TRUCK - 1WT
SILVERADO 1500 CREW CAB PICKUP HYBRID - 1HY**

LAW ENFORCEMENT PRODUCT COUNCIL



Mission Statement

To pledge an integrated partnership between General Motors and Law Enforcement. Together, we will identify, evaluate and promote enhancements to products and relationships that address the vehicle requirements of the Law Enforcement Community.

LAW ENFORCEMENT PRODUCT COUNCIL | 5



Terry Scissons
Royal Canadian Mounted Police
terry.scissons@rcmp-grc.gc.ca
613-993-3219



Oliver Harris
Tulsa Police Department
oharris@ci.tulsa.ok.us
918-669-6020



Keith Wilson
Michigan State Police
WilsonKeith@michigan.gov
517-322-1789



John Dillon
Federal Bureau of Investigation
john.dillon@ic.fbi.gov
202-324-4925



Gregory Dimesa
New York City Police Department
gregory.dimesa@nypd.org
718-476-7537



Jerry Newbury
Texas Department of Public Safety
jerry.newbury@dps.texas.gov
512-424-2043



Lloyd Dow
York Regional Police
176@yrp.ca
905-830-0303 Ext. 7380



Kyle Shelton
Colorado State Patrol
kyle.shelton@cdps.state.co.us
303-273-1660



Ed Sanow
Law and Order Magazine
esanow@hendonspub.com
800-843-9764 Ext. 28



Tammie Turcott
Phoenix Police
tammie.turcott@phoenix.gov
602-261-8393



Max Thomson
L.A. County Sheriffs Department
msthomson@lasd.org
323-881-3985

LEPC members are available to all of law enforcement for questions, comments, or ideas you wish to convey to General Motors.

REGIONAL GOVERNMENT SALES REPRESENTATIVES



Sales and Service

8 | DISTRICT SALES MANAGERS COMMERCIAL AND GOVERNMENT

WESTERN REGION

PAUL RYAN
PHONE: 925-324-1602
paul.ryan@gm.com
AREA: Northern CA

DAN WONG
PHONE: 214-316-9530
dan.wong@gm.com
AREA: Southern CA, HI

ROBERT L. SHANKLIN
PHONE: 503-758-7089
robert.shanklin@gm.com
AREA: OR, WA, AK

SUE SMITHSON
PHONE: 303-549-0460
susan.smithson@gm.com
AREA: CO, NM, WY

RICH H. PATTERSON
PHONE: 602-228-1286
rich.h.patterson@gm.com
AREA: AZ

JACK SMITH
PHONE: 602-228-2653
freddy.smith@gm.com
AREA: UT, NV, ID, MT

SOUTH CENTRAL REGION

STEPHEN PADILLA
PHONE: 210-563-1229
stephen.x.padilla@gm.com
AREA: South Texas

DAVE KOZIOL
PHONE: 901-482-1165
david.m.koziol@gm.com
AREA: Memphis, AR, LA, MS

VIVIAN MULLINS
PHONE: 313-570-1931
vivian.mullins@gm.com
AREA: East Texas

RICK MAYBURY
PHONE: 817-909-6457
rick.maybury@gm.com
AREA: West Texas, OK

RON MEALMAN
PHONE: 913-961-7050
ronald.j.mealman@gm.com
AREA: MO, KS, NE

BILL HAJDUK
SALES SUPPORT MANAGER
POLICE/MUNICIPAL VEHICLES
PHONE: 214-616-8166
bill.hajduk@gm.com
Area: AR, KS, LA, MO, MS, NE, OK, TX

SOUTHEAST REGION

DAR ALFORD
PHONE: 513-262-6301
darwin.d.alford@gm.com
AREA: TN, KY, WV

JAMES MELLON
PHONE: 407-375-4801
james.mellon@gm.com
AREA: FL, PR

BILLY REGAR
SALES SUPPORT MANAGER
POLICE/MUNICIPAL VEHICLES
PHONE: 386-295-5637
billy.regarsr@gm.com
AREA: FL

TED PFISTER
PHONE: 407-319-4621
ted.pfister@gm.com
AREA: GA, AL

KEVIN FRASZ
PHONE: 704-651-9390
kevin.1.frasz@gm.com
AREA: NC, SC

NORTH CENTRAL REGION

PATRICK DEMPSEY
PHONE: 813-431-5739
patrick.e.dempsey@gm.com
AREA: IL

RICH GUNTHER
PHONE: 414-559-3016
richard.gunther@gm.com
AREA: WI, IA

LEE KIRBY
PHONE: 215-284-3310
lee.kirby@gm.com
AREA: MN, ND, SD

LARRY SPEICHER
PHONE: 630-222-5464
larry.d.speicher@gm.com
AREA: MI, IN

MIKE WILSON
PHONE: 330-704-8904
mike.1.wilson@gm.com
AREA: OH

NORTHEAST REGION

ANDREW HAGER
PHONE: 248-514-0318
andrew.j.hager@gm.com
AREA: MD, Metro DC, DE, VA

LINDA MCCLURE
PHONE: 203-240-5641
linda.mcclure@gm.com
AREA: CT, NY

SHARON BRADLEY
PHONE: 412-558-1969
sharon.k.bradley@gm.com
AREA: PA, NJ

BRAD ROSE
PHONE: 508-269-6152
brad.rose@gm.com
AREA: MA, NH, ME, RI, VT

CANADA

WILL BACHEWICH
PHONE: 905-644-1051
will.bachewich@gm.com
AREA: Canada

FOR ADDITIONAL ASSISTANCE

Phone: 1-800-FLEET-OP (353-3867)

www.gmfleet.com

EASTERN REGION

JAY LEWIS

PHONE: 516-458-7994

jay.lewis@gm.com

Area: ME, NH, VT, MA, RI, CT, E. NY

MARK MONISMITH

PHONE: 248-672-9179

mark.l.monismith@gm.com

Area: North GA, AL, TN, KY, WV

DANA BRODBECK

PHONE: 239-272-5752

dana.d.brodbeck@gm.com

Area: FL, SC, S. GA, NC, VA

TBD

Area: MD, DE, PA, NJ, W. NY

NORTH CENTRAL REGION

RICH MOORE

PHONE: 630-531-1663

rich.moore@gm.com

Area: N. IL, WI, MN, IA, ND, SD

MIKE BATCHIK

PHONE: 313-570-0329

mike.batchik@gm.com

Area: MI, OH, IN, S. IL, MO

WESTERN REGION

JERRY BARTZ

PHONE: 228-365-6810

gerald.i.bartz@gm.com

Area: E. TX, AR, MS, LA

MIKE HURRELL

PHONE: 214-604-9247

michael.hurrell@gm.com

Area: NM, TX, OK

SCOTT BRUSKE

PHONE: 602-885-2229

scott.bruske@gm.com

Area: AK, AZ, South CA, CO, NM, NV, WY

MARK ROMANS

PHONE: 916-517-2418

mark.romans@gm.com

Area: North CA, UT, WA, OR, ID, MT, HI

FOR ADDITIONAL ASSISTANCE

Phone: 1-800-FLEET-OP (353-3867)

www.gmfleet.com

UPDATES FOR 2012



NEW FEATURES

- (LFX) 3.6L V6 DOHC SIDI engine with Variable Valve Timing (VVT)
- (7X7) Driver and passenger-side spotlamps
- (7X9) Driver and passenger-side spotlamp provisions
- (W2P) Full wheels covers available
- (GYW) Hugo (dark blue) metallic paint
- Rollover protection (See page 2 for description)
- Engine run and engine idle hour meters shown in driver information display
- Knee air bags¹
- Front passenger door lock cylinder
- Autonet Mobile WiFi in-car router available (see page 15 for description)

CHANGES

- RPO code (SG8) replaces RPO code (QQ5) for the full-size spare tire and wheel
- Optional air bag RPO code (AYO) changed to RPO code (AYG)

¹ Head curtain side air bags are designed to help reduce the risk of head and neck injuries to front and rear seat occupants on the near side of certain side-impact collisions. Always use safety belts and the correct child restraints for your child's age and size, even in vehicles equipped with air bags. Children are safer when properly secured in a rear seat. See your vehicle Owner's Manual and child safety seat instructions for more information.

2 | CAPRICE POLICE PACKAGE PPV – 9C1

*This vehicle has been designed for police work up to and including high speed emergency vehicle operations.
GM restricts the sale of police vehicles and they are not to be sold to retail customers.*

MODEL AVAILABILITY

1EW19 - 9C1

Rear-wheel drive

STANDARD EQUIPMENT SUMMARY

WARRANTY

3 years / 36,000 mile bumper-to-bumper limited warranty (whichever comes first, see dealer for details)
5 years / 100,000 mile powertrain limited warranty (whichever comes first, see dealer for details)

INTERIOR FEATURES

AIR CONDITIONING

Dual-zone electronic climate control with pollen air filtration

BOTTLE HOLDER

Bottle holder in the front doors

COMPASS

Located inside rearview mirror

CRUISE CONTROL

Electronic with set and resume speed

DOME LAMPS

Front and rear dome lamps (excludes map lamps) The front dome lamp has switches for ON/OFF and OFF when a door is opened, vehicle unlocked or key removed from ignition (see page 16 for picture and description)

FLOOR COVERING

Carpeted (front and rear carpeted floor mats are available; see option B34. Option 6A3 heavy-duty vinyl floor covering available, requires AEH vinyl rear seat; see page 9)

GLASS

Tinted windshield and Solar-Ray glass, driver and front passenger door

GLOVE BOX

Locking door with light

MIRROR, REARVIEW

Manual day, night

OUTSIDE TEMP. DISPLAY

Standard

RADIO

AM/FM stereo, seek-scan, single CD (supports MP3/WMA), auto-tune with two tweeters, two front door speakers and two rear door speakers

RESTRAINT SYSTEM

Safety belts, driver and front passenger with pretensioners, dual stage frontal air bags¹ and a passenger sensing system with passenger frontal air bag ON/OFF indicator. Driver and front passenger head side curtain air bags¹, knee air bags and front seat back mounted thorax air bags. A Rollover Sensing System senses an impending rollover and deploys the head side curtain air bags¹ and seat belt pretensioners in the event. The head side curtain air bags¹ are designed to remain inflated for a longer period than the frontal, knee and thorax air bags¹ to reduce the likelihood of occupant head and torso excursion outside the passenger compartment if a rollover should occur. (Combined front and rear seat row head side curtain air bags¹ are available; see option AYG)
Note: Safety belt extenders are available in 9 inch (part number 89027366) and 15 inch (part number 89027367) through your dealer at no charge

SEAT, FRONT

Cloth bucket seats with heavy duty foam, sculptured for gun belts; high-wear fabric bolsters and seat back security panel. Driver 8-way power adjuster with reclining seat back, lumbar control and quick adjust manual fore-aft movement. Passenger 4-way power adjuster with manual fore-aft, recline and lumbar controls. Passenger 8-way power seat is available (see option AF6, p.9)

SEAT, REAR

Cloth bench, non-folding seat back (vinyl rear seat available; see option AEH on page 9, requires 6A3 heavy-duty vinyl floor covering)

SHIFT LEVER

Floor mounted without console and with shortened, offset shift lever (see page 12 for picture); 10 inches of open floor space between front seats for after market supplied equipment consoles

SMOKER'S PACKAGE

Not available

SPEEDOMETER/CLUSTER

160 mph certified analog with 1 mph increments; 1 mph redundant digital speed can be displayed in the Driver Information Center (DIC). The DIC displays trip, fuel, vehicle system and warning messages. Engine Run and Idle Hours are also displayed; if desired, Engine Oil Life can be enabled and displayed in the DIC

STEALTH MODE

See exterior lamps control on page 12 for operation and description

STEERING WHEEL

Tilt and telescoping with audio controls

THEFT DETERRENT SYSTEM

Vehicle, PASS-Key® III+ (for Vehicle Content Theft Option BTV Remote vehicle start must be ordered)

TRAP SPEED FEATURE

Traps (stores) certified vehicle speed in digital speedometer via steering wheel controls when following another vehicle

VISOR

Driver and passenger with covered mirrors, not illuminated

WARNING LIGHTS

Brake, safety belt, air bag, anti-lock, check engine, StabiliTrak, high beam and cruise control

WARNING TONES

Key-in-ignition, driver door open and safety belt reminder chime

WINDOW OPERATION

Power front and rear, automatic down front only with rear window lockout (controls located on front door panels)

ELECTRICAL FEATURES

AUXILIARY POWER, FRONT

110-amp ignition and main power supply wiring harness under lower right side of instrument panel. One 50-amp battery power circuit and two 30-amp relay controlled circuits are in a five foot coil provided for customer connection. Included in the harness are signal circuits for ignition power (HOT in START/RUN and ACCESSORY/RUN), vehicle radio mute, vehicle speed signal and park-enable

AUXILIARY POWER, TRUNK

120-amp auxiliary power available in trunk

GROUND STUD

Auxiliary, located in trunk

POWER OUTLETS

One located on instrument panel

WIRING PROVISIONS FOR:

EXTERIOR LAMPS FLASHING

Forward lamp in-line connector for Exterior Lamp Flashing System (see option 6J7 on page 9)

RADIO MUTE

A circuit is provided to mute the vehicle radio when a customer ground is applied (see Caprice wiring diagram section for details)

1. Head curtain side air bags are designed to help reduce the risk of head and neck injuries to front and rear seat occupants on the near side of certain side-impact collisions. Always use safety belts and the correct child restraints for your child's age and size, even in vehicles equipped with air bags. Children are safer when properly secured in a rear seat. See your vehicle Owner's Manual and child safety seat instructions for more information.

EXTERIOR FEATURES

ANTENNA	Radio, roof mounted (center of roof near rear window)
DEFOGGER	Electric, rear window
DOOR LOCKS	Power door locks (automatic door locking and unlocking feature is disabled; customer can re-program to enable the feature using instructions found in the Owners Manual). A keylock cylinder is standard on the passenger front door; child safety locks in rear doors
HEADLAMPS	Halogen, automatic lamp control with daytime running lamps. (For daytime running lamps delete see option VVS on page 9)
HORNS	Dual note
KEYLESS ENTRY	Includes two integrated keys and FOBs; the keyless entry system used on the Police Caprice includes a stealth mode feature. When the “unlock” or “lock” button is depressed, no exterior lamps or audible sounds are activated; however, the interior standard equipment dome lamp will illuminate at night unless option 7Y6, inoperative dome and courtesy lamps, is ordered (for additional transmitters option AMF must also be ordered)
KEYS	2 keys with integrated remote keyless entry, side milled, two-sided, random code for ignition, driver door and trunk; options 6E3 or 6E4 available for single key locking of entire fleet.
LICENSE PLATE FRONT	Mounting hardware included
MIRRORS, OUTSIDE REARVIEW	Black, electric left hand and right hand remote with manual folding (heated available; see option DR9 on page 9)
ONSTAR	Not available
PAINT	Base coat/clear coat
TRUNK LAMP	Standard
TRUNK RELEASE	Electric, ignition controlled switch, located on instrument panel, with keylock cylinder on trunk lid
UNDER HOOD LAMP	Not available
WINDSHIELD WIPERS	Intermittent, 2-speed with variable dwell and vehicle speed dependant

CHASSIS FEATURES

ALTERNATOR	170-amp, with idle boost (transmission in PARK or NEUTRAL) controlled by battery energy level sensing
AXLE	2.92 axle ratio with limited slip standard with V8. Limited slip optional with V6
BATTERY	700 cca with battery rundown protection (does not protect customer installed equipment), located in trunk. Optional 600 cca, 70 amp hour auxiliary battery for accessory equipment is available; see option K45 on page 9
BODY	Body frame integral (unibody)
BRAKES	Power 4-wheel anti-lock heavy-duty disc brakes with police calibration
COOLING	Electric cooling fans, independently fused; coolant hoses are EPDM (ethylene-propylene-diene monomer); coolant is DEXCOOL, good for 5 years/150,000 miles (maintenance needs vary with different uses and driving conditions; see the Owners Manual for information); protects from -34 to +265 F and against rust and corrosion
CHASSIS LUBRICATION	Lubed-for-life chassis
ENGINES	Standard 3.6L V6 DOHC SIDI engine with Variable Valve Timing (VVT) and FlexFuel ² (gas or E85 Ethanol). Optional (no additional charge) 6.0L V8 with FlexFuel ² (gas or E85 ethanol) Active Fuel Management™; V6 and V8 engines include wide open throttle air conditioning cut off (when overhead lamps, spotlamps, radio antennas, sirens, and other emergency equipment are installed, overall performance may be reduced)
ENGINE CRADLE	Steel
EXHAUST SYSTEM	Stainless steel, dual
FUEL TANK CAPACITY	19 gallons (71.6 Liters), approximate
OIL COOLERS	Transmission and Power Steering with V6, Engine, Transmission and Power Steering with V8
RADIO SUPPRESSION	Extended life - iridium tip spark plugs and wires that are designed to reduce radio frequency noise levels which may affect communications equipment including operating frequencies in the 38-MHz to 58-MHz range. The Caprice is designed with unibody construction, and multiple grounding points are provided for the vehicle electrical system. No additional ground straps are added for the Police Package
STABILITRAK	Stability enhancement system. An advanced computer controlled system that assists the driver with directional control of the vehicle in difficult driving conditions. Each time the vehicle is started, the StabiliTrak system is fully on. StabiliTrak can be controlled by a StabiliTrak button on the instrument panel. The condition of the system is displayed by an instrument panel StabiliTrak indicator light and Driver Information Center (DIC) Messages. Push once, Performance Mode is active and Traction Control is off, push and hold five seconds Traction Control and StabiliTrak is off, push again and Traction Control and StabiliTrak are turned back on
STARTER INTERRUPT	Prevents starter from engaging while the engine is running
STEERING	Power, rack and pinion
SUSPENSION	4-wheel independent with coil springs, front and rear stabilizer bars. Patrol vehicle specific shock, spring and stabilizer bar tuning
TIRES	Goodyear P235/50R18 W-rated blackwall with compact spare (full-size spare is available; see option SG8 on page 9)
TIRE PRESSURE MONITOR	CHECK TIRE PRESSURE will show on driver message center (excludes spare tire)
TRACTION CONTROL	Deactivated when police performance mode is engaged
TRANSMISSION	6-speed automatic, electronically-controlled transmission provides protection against over-revving the engine in low gear; if a driver manually selects low gear, the powertrain control module automatically protects the drivetrain. Includes sport shift mode where maximum transmission responsiveness is required. When in sport shift mode, the transmission will delay upshifts and allow earlier downshifts. In addition, the transmission can sense enthusiastic driving, at which point it may delay upshifting and downshifting earlier when braking. This is designed to maximize vehicle performance
WHEELS	18" x 8" heavy-duty steel
WHEEL CENTER CAP	Bolt-on pressed/forged aluminium

2. E85 is 85% ethanol and 15% gasoline. To see if there is an E85 station near you, go to www.gmaltfuel.com/e85-station-locator.

4 | CAPRICE POLICE PACKAGE – 9C1

POWERTRAIN							
ENGINE				TRANSMISSION		AXLE	
OPTION CODE	TYPE	DISPLACEMENT LITERS/CU. IN.	FUEL SYSTEM	OPTION CODE	TYPE	OPTION CODE	RATIO
LFX Standard	V6	3.6/217	E85 FlexFuel ² or gasoline	MX0/MYA	6L45 6-speed auto. with OD	GW8 G80 (opt.)	2.92 Limited slip
L77 Optional no additional charge	V8	6.0/364	E85 FlexFuel ² or gasoline Active Fuel Management™	MX0/MYC	6L80 6-speed auto. with OD	GW8 G80 (std.)	2.92 Limited slip

EMISSIONS - MUST BE SPECIFIED	
FE9	FEDERAL EMISSIONS. Use for ordering vehicles that will be registered in all states except California, Connecticut, Maine, Maryland, Massachusetts, New Jersey, New Mexico, New York, Oregon, Pennsylvania, Rhode Island, Vermont and Washington State
YF5	CALIFORNIA EMISSIONS. Use for ordering vehicles that will be registered in California.
NE1	CT/ME/MD/MA/NJ/NM/NY/OR/PA/RI/VT/WA EMISSIONS. Use for ordering vehicles that will be registered in Connecticut, Maine, Maryland, Massachusetts, New Jersey, New Mexico, New York, Oregon, Pennsylvania, Rhode Island, Vermont or Washington State
NB8	Required when option code FE9 "FEDERAL EMISSIONS" is ordered for delivery to a dealer located in California, Connecticut, Massachusetts, Maryland, New Jersey, New Mexico, New York, Oregon, Pennsylvania, Rhode Island and Washington State for a purchaser who will be registering the vehicle outside California, Connecticut, Maine, Maryland, Massachusetts, New Jersey, New Mexico, New York, Oregon, Pennsylvania, Rhode Island, Vermont and Washington State.
NC7	Required when option code YF5 "CALIFORNIA EMISSIONS" or option code NE1 "CT/ME/MD/MA/NJ/NM/NY/OR/PA/RI/VT/WA EMISSIONS" is ordered for delivery to a dealer located in any state except California, Connecticut, Maine, Maryland, Massachusetts, New Jersey, New Mexico, New York, Oregon, Pennsylvania, Rhode Island, Vermont and Washington for a purchaser who will be registering the vehicle in one of these states or sold as permitted below under "EPA Policy on the Sale of California Emission Vehicles"
NB9	Required when option code YF5 is ordered for delivery to a dealer located in Connecticut, Maine, Maryland, Massachusetts, New Jersey, New Mexico, New York, Oregon, Pennsylvania, Rhode Island, Vermont and Washington. Required when option code NE1 is ordered for delivery to a dealer located in California.

TIRES - SPEED RATED				
MANUFACTURER	QUANTITY	SIZE	SPEED RATING	TYPE
Goodyear	4	P235/50R18	W	All season

Note: • Compact spare is standard (full-size spare is available see option QQ5 on page 9)
• Due to specific requirements for performance, durability and safety, GM recommends only the original equipment tire for replacement

SEATS AND INTERIOR TRIM			
		SEAT OPTIONS	ONYX
STANDARD	Front: Cloth buckets Rear: Cloth bench (non-folding seatback)	AAW	4BB
OPTIONAL	Front: Cloth buckets Rear: Vinyl bench Includes 6A3 heavy-duty vinyl floor covering (non-folding seatback)	AEH	4BB

AVAILABLE EXTERIOR COLORS							
							
Hugo Blue* (Dark Blue) Metallic	Heron White	Red Hot	Karma Metallic	Phantom Black Metallic	Mirage Gold Metallic	Silver Ice Metallic	Alto Grey Metallic

* Extra cost (orders that contain less than 20 orders will be delayed until 20 unit minimum is received for batch production. Will Require additional lead time)
Actual colors may vary

2. E85 is 85% ethanol and 15% gasoline. To see if there is an E85 station near you, go to www.gmaltfuel.com/e85-station-locator

UPDATES FOR 2012



NEW FEATURES

- (LFX) 3.6L V6 DOHC SIDI engine with Variable Valve Timing (VVT)
- (7X7) Driver and passenger-side spotlamp
- (7X9) Driver and passenger-side spotlamp provision
- (GYW) Hugo (dark blue) metallic
- Rollover protection (See page 2 for description)
- Engine run and engine idle hour meters shown in driver information display
- Knee air bags¹
- Front passenger door lock cylinder
- Autonet Mobile WiFi in-car router available (see page 15 for description)

CHANGES

- RPO code (SG8) replaces RPO code (QQ5) for the full-size spare tire and wheel
- Optional air bag RPO code (AYO) changed to RPO code (AYG)

1. Head curtain side air bags are designed to help reduce the risk of head and neck injuries to front and rear seat occupants on the near side of certain side-impact collisions. Always use safety belts and the correct child restraints for your child's age and size, even in vehicles equipped with air bags. Children are safer when properly secured in a rear seat. See your vehicle Owner's Manual and child safety seat instructions for more information.

6 | CAPRICE DETECTIVE POLICE PACKAGE – 9C3

*This vehicle has been designed for police work up to and including high speed emergency vehicle operations.
GM restricts the sale of police vehicles and they are not to be sold to retail customers.*

MODEL AVAILABILITY

1EW19 - 9C3 Rear-wheel drive

STANDARD EQUIPMENT SUMMARY

WARRANTY 3 years / 36,000 mile bumper-to-bumper limited warranty (whichever comes first, see dealer for details)
5 years / 100,000 mile powertrain limited warranty (whichever comes first, see dealer for details)

INTERIOR FEATURES

AIR CONDITIONING	Dual-zone electronic climate control with pollen air filtration
COMPASS	Located inside rearview mirror
CONSOLE	Center floor with center shifter and armrest (see page 12 for picture)
CRUISE CONTROL	Electronic with set and resume speed
CUP HOLDER	Cup holder in console and bottle holder in the front doors
DOMELAMPS	Front and rear dome lamps (excludes map lamps) The front dome lamp has switches for ON/OFF and OFF when a door is opened, vehicle unlocked or key removed from ignition (see page 16 for picture and description)
FLOOR COVERING	Carpeted (front and rear carpeted floor mats are available see option B34 on page 9)
GLASS	Tinted windshield and Solar-Ray glass, driver and front passenger doors only
GLOVE BOX	Locking door with light
MIRROR, REARVIEW	Manual day, night
OUTSIDE TEMP. DISPLAY	Standard
RADIO	AM/FM stereo, seek-scan, single CD (supports MP3/WMA), auto-tune with two tweeters, two front door speakers and two rear door speakers
RESTRAINT SYSTEM	Safety belts, driver and front passenger with pretensioners, dual stage frontal air bags ¹ and a passenger sensing system with passenger frontal air bag ON/OFF indicator. Driver and front passenger head side curtain air bags ¹ , knee air bags ¹ and front seat back mounted thorax air bags ¹ . A Rollover Sensing System senses an impending rollover and deploys the head side curtain air bags ¹ and seat belt pretensioners in the event. The head side curtain air bags ¹ are designed to remain inflated for a longer period than the frontal, knee and thorax air bags ¹ to reduce the likelihood of occupant head and torso excursion outside the passenger compartment if a rollover should occur. (Combined front and rear seat row head side curtain air bags ¹ are available; see option AVG) Note: Safety belt extenders are available in 9 inch (part number 89027366) and 15 inch (part number 89027367) through your dealer at no charge
SEAT, FRONT	Cloth bucket seats with heavy duty foam, sculptured for gun belts; high-wear fabric bolsters and seat back security panel. Driver 8-way power adjuster with reclining seat back, lumbar control and quick adjust manual fore-aft movement. Passenger 4-way power adjuster with manual fore-aft, recline and lumbar controls. Passenger 8-way power seat is available (see option AF6, page 9)
SEAT, REAR	Cloth bench, non-folding seat back (vinyl rear seat available; see option AEH on page 9, requires 6A3 heavy-duty vinyl floor covering)
SHIFT LEVER	Floor mounted in center of console (see page 12 for picture)
SMOKER'S PACKAGE	Not available
SPEEDOMETER/CLUSTER	160 mph certified analog with 1 mph increments; 1 mph redundant digital speed can be displayed in the Driver Information Center (DIC). The DIC displays trip, fuel, vehicle system and warning messages. Engine Run and Idle Hours are also displayed; if desired, Engine Oil Life can be enabled and displayed in the DIC
STEALTH MODE	See exterior lamps control on page 12 for operation and description
STEERING WHEEL	Tilt and telescoping with audio controls
THEFT DETERRENT SYSTEM	Vehicle, PASS-Key® III+ (for Vehicle Content Theft Option BTV remote vehicle start must be ordered)
TRAP SPEED FEATURE	Traps (stores) certified vehicle speed in digital speedometer via steering wheel controls when following another vehicle
VISOR	Driver and passenger with covered mirrors, not illuminated
WARNING LIGHTS	Brake, safety belt, air bag, anti-lock, check engine, StabiliTrak, high beam and cruise control
WARNING TONES	Key-in-ignition, driver door open and safety belt reminder chime
WINDOW OPERATION	Power front and rear, automatic down front only with rear window lockout (switches located on floor console)

ELECTRICAL FEATURES

AUXILIARY POWER, FRONT	110-amp ignition and main power supply wiring harness under lower right side of instrument panel. One 50-amp battery power circuit and two 30-amp relay controlled circuits are in a five foot coil provided for customer connection. Included in the harness are signal circuits for ignition power (HOT in START/RUN and ACCESSORY/RUN), vehicle radio mute, vehicle speed signal and a park-enable
AUXILIARY POWER, TRUNK	120-amp auxiliary power available in trunk
GROUND STUD	Auxiliary, located in trunk
POWER OUTLETS	Two auxiliary power outlets for additional plug-in equipment located on center console
WIRING PROVISIONS FOR:	
EXTERIOR LAMPS FLASHING	Forward lamp in-line connector for Exterior Lamp Flashing System (see option 6J7 on page 9)
RADIO MUTE	A circuit is provided to mute the vehicle radio when a customer ground is applied (see Caprice wiring diagram section for details)

1. Head curtain side air bags are designed to help reduce the risk of head and neck injuries to front and rear seat occupants on the near side of certain side-impact collisions. Always use safety belts and the correct child restraints for your child's age and size, even in vehicles equipped with air bags. Children are safer when properly secured in a rear seat. See your vehicle Owner's Manual and child safety seat instructions for more information.

EXTERIOR FEATURES

ANTENNA	Radio, roof mounted (center of roof near rear window)
DEFOGGER	Electric, rear window
DOOR LOCKS	Power door locks (automatic door locking and unlocking feature is disabled; customer can re-program to enable the feature using instructions found in the Owners Manual). A keylock cylinder is standard on the passenger front door; child safety locks in rear doors.
HEADLAMPS	Halogen, automatic lamp control with daytime running lamps. (For daytime running lamps delete see option VVS on page 9)
HORNS	Dual note
KEYLESS ENTRY	Includes two integrated keys and FOBs; the keyless entry system used on the Police Caprice includes a stealth mode feature. When the “unlock” or “lock” button is depressed, no exterior lamps or audible sounds are activated; however, the interior standard equipment dome lamp will illuminate at night unless option 7Y6, inoperative dome and courtesy lamps, is ordered (for additional transmitters option AMF must also be ordered)
KEYS	2 keys with integrated remote keyless entry, side milled, two-sided, random code for ignition, driver door and trunk; options 6E3 or 6E4 available for single key locking of entire fleet
LICENSE PLATE FRONT	Mounting hardware included
MIRRORS, OUTSIDE REARVIEW	Black, electric left hand and right hand remote with manual folding (heated available; see option DR9 on page 9)
ONSTAR	Not available
PAINT	Base coat/clear coat
TRUNK LAMP	Standard
TRUNK RELEASE	Electric, ignition controlled switch, located on instrument panel, with keylock cylinder on trunk lid
UNDER HOOD LAMP	Not available
WINDSHIELD WIPERS	Intermittent, 2-speed with variable dwell and vehicle speed dependant

CHASSIS FEATURES

ALTERNATOR	170-amp, with idle boost (transmission in PARK or NEUTRAL) controlled by battery energy level sensing
AXLE	2.92 axle ratio with limited slip standard with V8. Limited slip optional with V6
BATTERY	700 cca with battery rundown protection (does not protect customer installed equipment), located in trunk. Optional 600 cca, 70 amp hour auxiliary battery for accessory equipment is available; see option K45 on page 9
BODY	Body frame integral (unibody)
BRAKES	Power 4-wheel anti-lock heavy-duty disc brakes with police calibration
COOLING	Electric cooling fans, independently fused; coolant hoses are EPDM (ethylene-propylene-diene monomer); coolant is DEXCOOL, good for 5 years/150,000 miles (maintenance needs vary with different uses and driving conditions; see the Owners Manual for information); protects from -34 to +265 F and against rust and corrosion
CHASSIS LUBRICATION	Lubed-for-life chassis
ENGINES	Standard 3.6L V6 DOHC SIDI engine with Variable Valve Timing (VVT) and FlexFuel ² (gas or E85 Ethanol). Optional (no additional charge) 6.0L V8 with FlexFuel ² (gas or E85 ethanol) Active Fuel Management™; V6 and V8 engines include wide open throttle air conditioning cut off (when overhead lamps, spotlamps, radio antennas, sirens, and other emergency equipment are installed, overall performance may be reduced)
ENGINE CRADLE	Steel
EXHAUST SYSTEM	Stainless steel, dual
FUEL TANK CAPACITY	19 gallons (71.6 Liters), approximate
OIL COOLERS	Transmission and Power Steering with V6, Engine, Transmission and Power Steering with V8
RADIO SUPPRESSION	Extended life - iridium tip spark plugs and wires that are designed to reduce radio frequency noise levels which may affect communications equipment including operating frequencies in the 38-MHz to 58-MHz range. The Caprice is designed with unibody construction, and multiple grounding points are provided for the vehicle electrical system. No additional ground straps are added for the Police Package
STABILITRAK	Stability enhancement system. An advanced computer controlled system that assists the driver with directional control of the vehicle in difficult driving conditions. Each time the vehicle is started, the StabiliTrak system is fully on. StabiliTrak can be controlled by a StabiliTrak button on the instrument panel. The condition of the system is displayed by an instrument panel StabiliTrak indicator light and Driver Information Center (DIC) Messages. Push once, Performance Mode is active and Traction Control is off, push and hold five seconds Traction Control and StabiliTrak is off, push again and Traction Control and StabiliTrak are turned back on
STARTER INTERRUPT	Prevents starter from engaging while the engine is running
STEERING	Power, rack and pinion
SUSPENSION	4-wheel independent with coil springs, front and rear stabilizer bars. Patrol vehicle specific shock, spring and stabilizer bar tuning
TIRES	Goodyear P235/50R18 W-rated blackwall with compact spare (full-size spare is available; see option SG8 on page 9)
TIRE PRESSURE MONITOR	CHECK TIRE PRESSURE will show on driver message center (excludes spare tire)
TRACTION CONTROL	Deactivated when police performance mode is engaged
TRANSMISSION	6-speed automatic, electronically-controlled transmission provides protection against over-revving the engine in low gear; if a driver manually selects low gear, the powertrain control module automatically protects the drivetrain. Includes sport shift mode where maximum transmission responsiveness is required. When in sport shift mode, the transmission will delay upshifts and allow earlier downshifts. In addition, the transmission can sense enthusiastic driving, at which point it may delay upshifting and downshifting earlier when braking. This is designed to maximize vehicle performance
WHEELS	18" x 8" heavy-duty steel
WHEEL COVER	Full wheel covers

2. E85 is 85% ethanol and 15% gasoline. To see if there is an E85 station near you, go to www.gmaltfuel.com/e85-station-locator.

POWERTRAIN

ENGINE				TRANSMISSION		AXLE	
OPTION CODE	TYPE	DISPLACEMENT LITERS/CU. IN.	FUEL SYSTEM	OPTION CODE	TYPE	OPTION CODE	RATIO
LFX Standard	V6	3.6/217	E85 FlexFuel ² or gasoline	MX0/MYA	6L45 6-speed auto. with OD	GW8	2.92
						G80 (opt.)	Limited slip
L77 Optional no additional charge	V8	6.0/364	E85 FlexFuel ² or gasoline Active Fuel Management™	MX0/MYC	6L80 6-speed auto. with OD	GW8	2.92
						G80 (std.)	Limited slip

EMISSIONS - MUST BE SPECIFIED

FE9	FEDERAL EMISSIONS. Use for ordering vehicles that will be registered in all states except California, Connecticut, Maine, Maryland, Massachusetts, New Jersey, New Mexico, New York, Oregon, Pennsylvania, Rhode Island, Vermont and Washington State
YF5	CALIFORNIA EMISSIONS. Use for ordering vehicles that will be registered in California.
NE1	CT/ME/MD/MA/NJ/NM/NY/OR/PA/RI/VT/WA EMISSIONS. Use for ordering vehicles that will be registered in Connecticut, Maine, Maryland, Massachusetts, New Jersey, New Mexico, New York, Oregon, Pennsylvania, Rhode Island, Vermont or Washington State
NB8	Required when option code FE9 "FEDERAL EMISSIONS" is ordered for delivery to a dealer located in California, Connecticut, Massachusetts, Maryland, New Jersey, New Mexico, New York, Oregon, Pennsylvania, Rhode Island and Washington State for a purchaser who will be registering the vehicle outside California, Connecticut, Maine, Maryland, Massachusetts, New Jersey, New Mexico, New York, Oregon, Pennsylvania, Rhode Island, Vermont and Washington State.
NC7	Required when option code YF5 "CALIFORNIA EMISSIONS" or option code NE1 "CT/ME/MD/MA/NJ/NM/NY/OR/PA/RI/VT/WA EMISSIONS" is ordered for delivery to a dealer located in any state except California, Connecticut, Maine, Maryland, Massachusetts, New Jersey, New Mexico, New York, Oregon, Pennsylvania, Rhode Island, Vermont and Washington for a purchaser who will be registering the vehicle in one of these states or sold as permitted below under "EPA Policy on the Sale of California Emission Vehicles"
NB9	Required when option code YF5 is ordered for delivery to a dealer located in Connecticut, Maine, Maryland, Massachusetts, New Jersey, New Mexico, New York, Oregon, Pennsylvania, Rhode Island, Vermont and Washington. Required when option code NE1 is ordered for delivery to a dealer located in California.

TIRES - SPEED RATED

MANUFACTURER	QUANTITY	SIZE	SPEED RATING	TYPE
Goodyear	4	P235/50R18	W	All season

Note: • Compact spare is standard (full-size spare is available see option QQ5 on page 9)
• Due to specific requirements for performance, durability and safety, GM recommends only the original equipment tire for replacement

SEATS AND INTERIOR TRIM

	SEAT OPTIONS	ONYX
STANDARD Front: Cloth buckets Rear: Cloth bench (non-folding seatback)	AAW	4BB

AVAILABLE EXTERIOR COLORS

							
GYW Hugo Blue* (Dark Blue) Metallic	GII Heron White	GII Red Hot	GIG Karma Metallic	GIE Phantom Black Metallic	GST Mirage Gold Metallic	GAN Silver Ice Metallic	GGG Alto Grey Metallic

** Extra cost (orders that contain less than 20 orders will be delayed until 20 unit minimum is received for batch production. Will Require additional lead time)
Actual colors may vary*

2. E85 is 85% ethanol and 15% gasoline. To see if there is an E85 station near you, go to www.gmaltfuel.com/e85-station-locator.

CAPRICE POLICE PACKAGE 9C1 AND 9C3 – OPTIONS | 9

AYG	AIR BAG¹, HEAD CURTAIN ROOF RAIL MOUNTED - Combined front and rear passenger
G80	AXLE - Limited slip with V6 engine (Standard on V8 engine)
K4S	BATTERY, AUXILIARY - Optional 600 cca, 70-amp hour battery to power customer installed equipment. The auxiliary battery is connected to the charging system through an isolation relay to prevent emergency equipment electrical loads from depleting the vehicle primary battery if the engine is not running and the ignition is OFF. Located at the passenger side of the trunk
VVS	DELETE DAYTIME RUNNING LAMPS AND AUTOMATIC HEADLAMPS
L77	ENGINE - 6.0L V8 SFI with active fuel management, includes FlexFuel capability (no additional charge)
6J7	FLASHER SYSTEM, EXTERIOR LAMPS - DRL compatible, headlamp flasher module with wiring provisions to the front compartment for ON-OFF control and optional separate flashing of front and rear lamps (see page 19 for description)
6A3	FLOOR COVERING - Heavy-duty vinyl replaces production carpeting, (carpeted mats not available); included with AEH vinyl rear seat (not available on 9C3)
6B7	HOLE IN ROOF - On center line (not available with 6J5 hole) with sealing harness grommet in roof hole
6J5	HOLE IN ROOF - On passenger side (not available with 6B7 hole) with sealing harness grommet in roof hole
AMF	KEYS - 6 keys, cut, with integrated remote keyless entry; includes remote vehicle start if option BTV is ordered. Transmitters are not programmed. Each transmitter including the two standard with the vehicle, must be programmed together by the customer or by a dealer at customer expense. Transmitter programming is not a warranty item. See you owner's manual for additional programming information note: Common frequency keyless entry for fleet keyed vehicles not available; each fleet keyed vehicle will have a different keyless entry frequency
6E3	KEYS COMMON - Complete vehicle fleet, provides a single key with a specific code that is common to the door locks and ignition for all the vehicles in the vehicle fleet; key code is an alternate to SEO 6E4 key common, complete vehicle fleet; not compatible with Impalas and Tahoes police vehicles
6E4	KEYS COMMON - Complete vehicle fleet, provides a single key with a specific code that is common to the door locks and ignition of all the vehicles in the vehicle fleet; key code is an alternate to SEO 6E3 key common, complete vehicle fleet; not compatible with Impalas and Tahoes police vehicles
6C7	LAMP - Red and white front auxiliary dome, separately switched
7Y6	LAMP - Inoperative dome and courtesy lamps (dome and courtesy lamp will not operate when doors are opened. Dome lamp is controlled only by the instrument light dimmer switches on the instrument panel)
T53	LAMPS - Alternate flashing red and blue trunk lid warning LED lamps
B42	MAT - Trunk, custom, fitted, heavy-duty vinyl molded edge to keep spills contained, removable for easy cleaning
B34	MATS - Carpeted front and rear (not available with 6A3 heavy-duty vinyl floor covering)
DR9	MIRRORS - Heated outside rearview, power, manual folding, Black
6N6	REAR DOOR LOCKS AND HANDLES INOPERATIVE - Rear door locks are inoperable at rear door, operates only from driver's position, rear doors can be opened only from outside
6N5	REAR WINDOW SWITCHES - Rear windows only operate from driver's position
BTV	REMOTE VEHICLE START - During remote start operation, parking lamps will remain illuminated; includes vehicle content theft ; unauthorized entry sounds horn and lamps flash
A6F	SEAT - Front passenger power 8-way vertical and recline, manual fore and aft with bar includes power lumbar, recommended for agencies that operate with two officers
AEH	SEAT - Rear vinyl, includes 6A3 heavy-duty vinyl floor covering (not available on 9C3)
SGT	SPEED LIMITER - Limits top speed to 130 mph
7X6	SPOTLAMP, DRIVER - Separately fused, six inch, black housing with halogen lamp
7X7	SPOTLAMP, DRIVER AND PASSENGER - Separately fused, six inch, black housing with halogen lamp
7X8	SPOTLAMP PROVISION DRIVER - Includes bracket with pillar hole sealed
7X9	SPOTLAMP PROVISION DRIVER AND PASSENGER - Includes bracket with pillar hole sealed
SG8	TIRE, SPARE - Full-size (includes TPM sensor not programed)
WX7	WIRING - For customer connection to front door and windshield pillar speakers. Speakers are not connected to the vehicle radio; radio audio signals are routed to the rear speakers
6J3	WIRING - For grille lamps and siren speaker
6J4	WIRING - For horn/siren circuit, in-line connection for customer furnished switch
W2P	WHEEL COVERS, FULL - Available for 9C1 (Replaces center caps) standard on 9C3 AUTONET MOBILE WIFI IN-CAR ROUTER - Available through your GM Dealer (see page 15 for Description)

1. Head curtain side air bags are designed to help reduce the risk of head and neck injuries to front and rear seat occupants on the near side of certain side-impact collisions. Always use safety belts and the correct child restraints for your child's age and size, even in vehicles equipped with air bags. Children are safer when properly secured in a rear seat. See your vehicle Owner's Manual and child safety seat instructions for more information.

10 | CAPRICE POLICE PACKAGE SPECIFICATIONS

GENERAL

Model	1EW19
Drive	Rear-wheel
EXTERIOR (in./mm)	
Wheelbase	118.5/3010.0
Overall length	204.2/5187.0
Overall width (excluding mirrors)	74.8/1898.7
Overall height	58.7/1490.0
Front track width	62.8/1596.0
Rear track width	63.2/1606.0
Turning diameter curb to curb (ft./m)	38.0/11.7
Ground clearance (engine cradle)	5.6/142.2

FRONT COMPARTMENT (in./mm)

Head room	38.7/984.0
Shoulder room	59.1/1501.3
Hip room	56.7/1438.9
Leg room (maximum)	42.2/1072.0

REAR COMPARTMENT (in./mm)

Head room	37.6/955.0
Shoulder room	59.0/1498.0
Hip room	57.9/1472.1
Leg room (minimum)	43.2/1098.0

LUGGAGE COMPARTMENT CAPACITY (cu.ft./liters)

Luggage capacity ³ (includes full-size spare tire and auxiliary battery)	17.4/492.71
---	-------------

PASSENGER COMPARTMENT VOLUME INDEX (cu.ft./liters)

EPA passenger compartment volume index ³	112/3171.5
---	------------

FUEL ECONOMY RATINGS CITY/HIGHWAY/COMBINED

3.6L V6 engine ⁴	18/26/21
6.0L V8 engine ⁴	15/24/18

ALTERNATOR

Type	9G135
Amps	170

CAPRICE POLICE ALTERNATOR OUTPUT

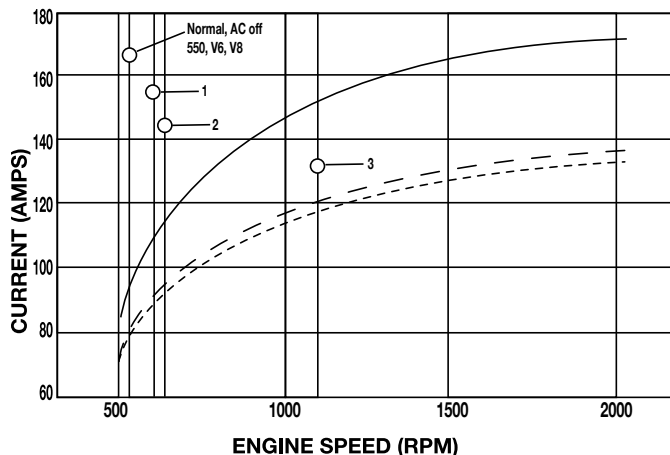

————— 14.0V / 77° F (25° C)	V6	V8
- - - - - 13.25V / 221° F (105° C)	Idle Boost 1 = 600 RPM	650 RPM
- - - - - 13.0V / 257° F (125° C)	Idle Boost 2 = 700 RPM	700 RPM
Idle 121-amps @1100 RPM (Idle Boost 3@221° F)	Idle Boost 3 = 1100 RPM	1100 RPM

- Cargo and load capacity limited by weight and distribution.
- EPA-estimated MPG.
- Gross Vehicle Weight Rating (GVWR). When properly equipped, includes vehicle, passengers, cargo and equipment.
- Maximum payload capacity includes weight of driver, passengers, optional equipment and cargo.

ENGINE

	STANDARD	OPTIONAL
Type	V6	V8
Displacement: liters/cu. in.	3.6/217	6.0/364
Horsepower/rpm	301@6700	355@5300
Torque lb.-ft./rpm	265@4800	384@4400
Induction system	SIDI	SFI
Compression ratio	11.3:1	10.4:1
Exhaust	Dual	Dual
Minimum recommended fuel octane	87	87
Fuel tank capacity, approximate (gallons/liters)	19/72	19/72
Cooling capacity (quarts/liters)	10.6/10	11.6/11
Oil with filter (quarts/liters)	7.1/6.7	8.0/7.6

TRANSMISSION

Automatic, electronically-controlled with overdrive	6-speed	6-speed
Fluid pan removal & filter replace (quarts/liters)	11.9/11.3	6.7/6.3

AXLE RATIO

With V6 Engine	2.92	
With V8 Engine includes limited slip		2.92

BRAKES

4-wheel disc with ABS	Disc/Disc
Front - swept area (sq. in./sq. cm)	310.6/788.9
Rear - swept area (sq. in./sq. cm)	211.4/537.0
Total front and rear swept area (sq. in./sq. cm)	522.04/3368
Front rotor diameter (in./mm)	13.58/345
Rear rotor diameter (in./mm)	12.76/324
Front rotor thickness (in./mm)	1.18/30
Rear rotor thickness (in./mm)	.87/22

TIRES

Type	Goodyear Eagle RS-A all season W-speed rated
Size	P235/50R18

WHEELS

Type	Steel
Size	18" X 8"

CHASSIS

Frame	Unibody
Engine cradle	Steel
Suspension	4-wheel independent with coil springs, front and rear stabilizer bars Patrol vehicle specific shock, spring and stabilizer bar tuning
Steering type	Variable ratio, rack-and-pinion
Steering ratio (non-variable)	17.5:1 on center/12.7:1 at full lock

BATTERY

	STANDARD	OPTIONAL AUXILIARY
Type	Maintenance free	Maintenance free
BCI group size	LN4	LN3
Volts	12	12
Amp hour rating	80	70
Cold cranking amps @ 0°F (-18°C)	700	600
Reserve capacity @ 80°F (27°C)	140 minutes	120 minutes

VEHICLE WEIGHT (Lbs./kg.)

	V6	V8
GVWR ⁵	5247/2380	5357/2430
Base curb (vehicle without original manufactures optional equipment)	4043/1834	4160/1887
Payload ⁶ (with bucket seats)	926/420	925/420

Note: See your vehicle tire and loading information label for specific weight values. See your owner's manual supplement for proper cargo loading distribution

ESTIMATED MATERIAL SIZES TO WRAP

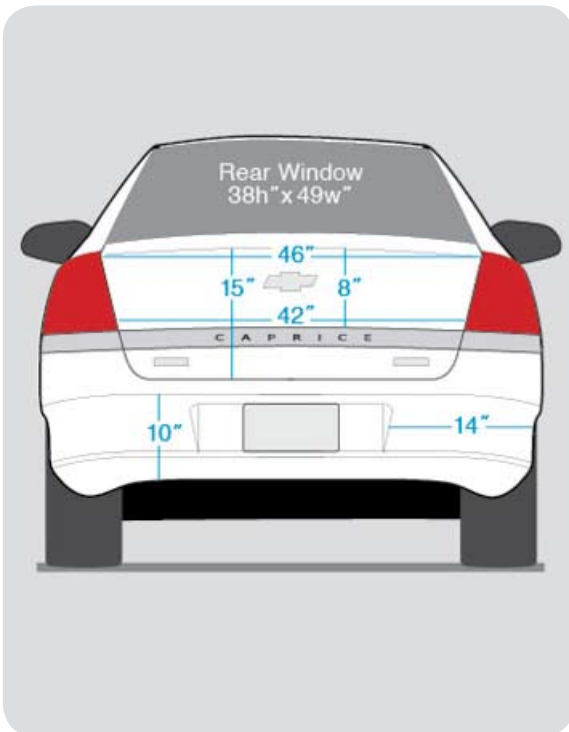
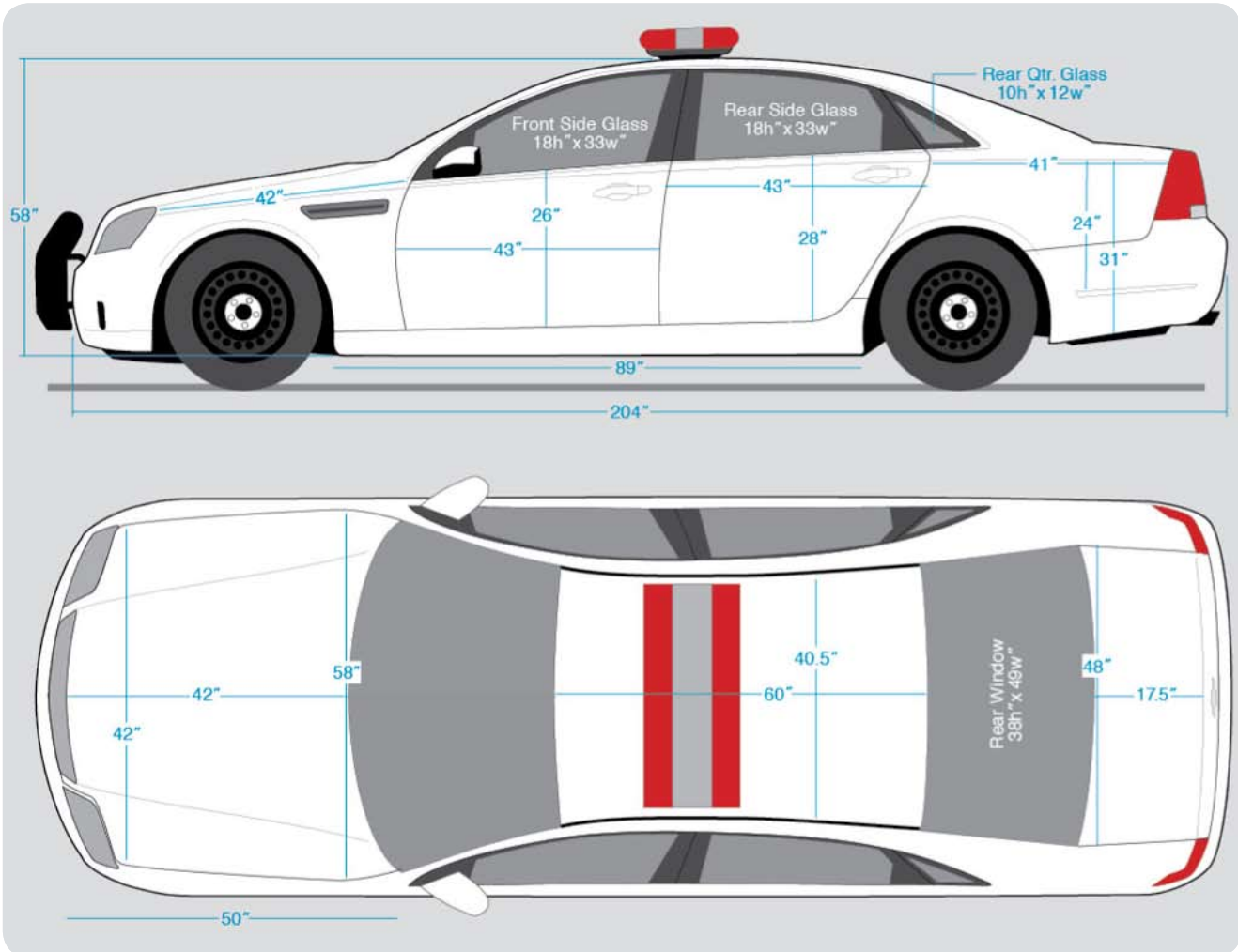

- Hood – 56" x 60" (Includes areas next to grill)
- Hood – 42" x 60" (Excludes areas next to grill)
- Front Doors – 45" x 30"
- Rear Doors – 45" x 32"
- Roof – 45" x 64"
- Trunk Lid – 38" x 50"

UNITED STATES CERTIFIED SPEEDOMETER/CLUSTER (CANADIAN SIMILAR)

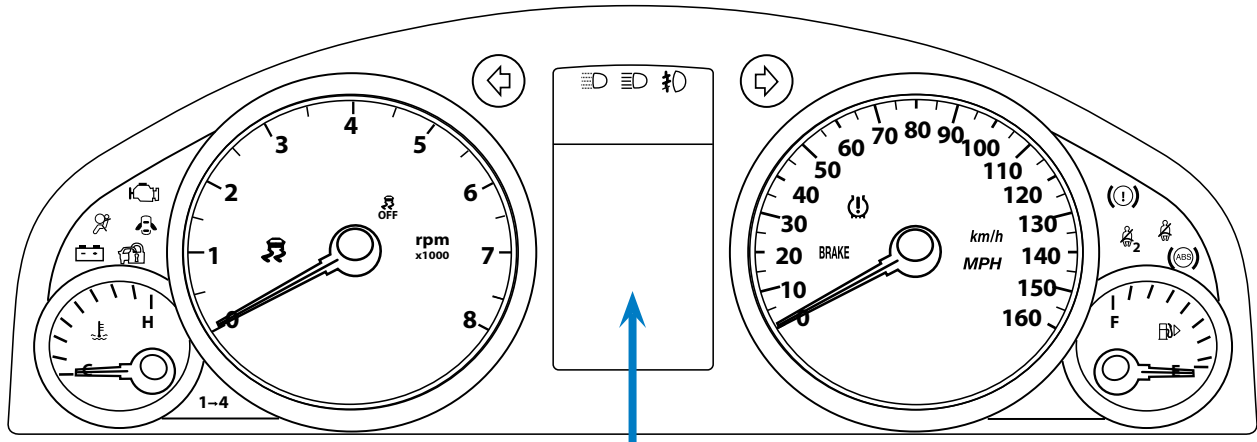

DRIVER INFORMATION MESSAGE CENTER

ELECTRICAL FUNCTION CUSTOMIZATION FEATURE

AUTO DOOR LOCKING	
DISABLED*	No automatic door locking
AT VEHICLE SPEED	Automatic lock all doors when vehicle speed is above 8 mph (13 kph)
OUT OF PARK	Automatic lock all doors when the shifter is moved out of park.
AUTO DOOR UNLOCKING	
DISABLED*	No automatic door unlocking
FRONT DOORS AT KEY OUT	Automatic unlock when key is removed from the ignition switch
ALL DOORS AT KEY OUT	Automatic unlock when key is removed from the ignition switch
FRONT DOORS IN PARK	Automatic unlock when the shifter is moved into park
ALL DOORS IN PARK	Automatic unlock when the shifter is moved into park
VISUAL FEEDBACK ON REMOTE LOCK/UNLOCK	
DISABLED*	No turn indicator lamps flash on remote lock and unlock
ENABLED	Flash turn indicator lamps on remote lock and unlock
AUDIBLE FEEDBACK REMOTE LOCK	
(NO MENU OPTION – FEATURE IS PERMANENTLY DISABLED)	
DISABLED*	No horn chirp on lock
REMOTE START	
(IF OPTION BTV IS ORDERED)	
DISABLED	Remote Start will not function
ENABLED*	Remote Start available via remote key FOB

APPROACH LAMPS	
DISABLED*	No approach lamps
ENABLED	Turn on approach lamps with remote unlock
EXIT LAMPS TIMER	
DISABLED*	No exit lamps after key off
30 SECONDS	Turn on exit lamps for 30 seconds after key off
60 SECONDS	Turn on exit lamps for 60 seconds after key off
90 SECONDS	Turn on exit lamps for 90 seconds after key off
180 SECONDS	Turn on exit lamps for 180 seconds after key off
TWO-STAGE UNLOCKING	
DISABLED	Single-stage unlocking of all door locks
ENABLED*	Two-stage unlocking of front then rear door locks

** Indicates the factory default setting*

STEERING WHEEL CONTROL FOR CUSTOMIZATION

Electrical Features may be changed from the factory default settings by using the TRIP button to scroll to the Customization Menu displayed in driver information center and pressing the ENTER button. Scroll through the Customization Menu by rotating the ENTER button up or down. Press ENTER to select a feature to be changed. See your owner's manual for additional directions for customizing your Caprice Police Package electrical functions listed in the chart above.

UNITED STATES CERTIFIED SPEEDOMETER/CLUSTER (CANADIAN SIMILAR)

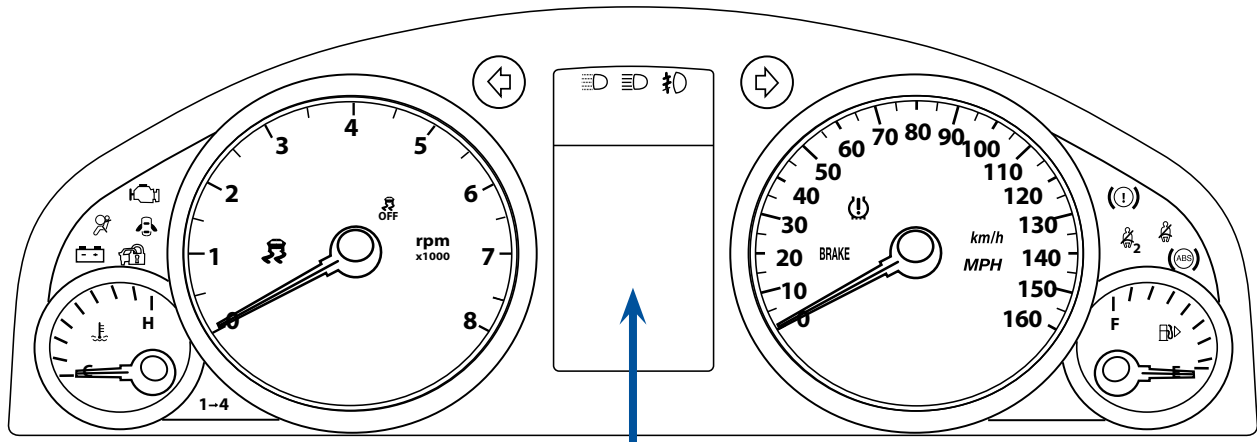

DRIVER INFORMATION MESSAGE CENTER

MESSAGES SHOWN

<p>SPEEDOMETER (DIGITAL SPEED IS DISPLAYED; TRAP SPEED FEATURE CAPTURES VEHICLE SPEED WHEN THUMBWHEEL IS PUSHED)</p>	<p>INSTANTANEOUS FUEL / CYLINDER MODE (INSTANTANEOUS FUEL DISPLAYS MILES / GALLON OR BELOW 6 MPH, GALLONS / HOUR; CAN BE TURNED ON OR OFF)</p>				
<p>UNITS (ENGLISH / METRIC)</p>	<p>AVERAGE SPEED / AVERAGE FUEL (RESETTABLE; CAN BE TURNED ON OR OFF)</p>				
<p>TIRE PRESSURE (DISPLAYS ALL FOUR TIRE PRESSURES)</p>	<p>ENGINE RUNNING HOURS (CAN BE TURNED ON OR OFF)</p>				
<p>CUSTOMIZE OPTIONS (SEE PAGE 11 FOR LISTING AND OPTIONS)</p>	<p>ENGINE IDLE HOURS (CAN BE TURNED ON OR OFF)</p>				
<p>ENGINE OIL LIFE REMAINING (DISPLAYS PERCENT REMAINING FROM LAST RESET AT OIL CHANGE; CAN BE TURNED ON OR OFF)</p>	<p>CERTIFIED SPEEDOMETER (WILL APPEAR WHEN VEHICLE IS STARTED)</p>				
<p>ODOMETER / TRIP ODOMETER (TRIP ODOMETER IS RESETTABLE)</p>	<p>SPEEDOMETER CERTIFICATION 2012 Caprice police cars certified speedometer calibration. Specifications, at ambient temperature of -10 to 120 degrees F. Inaccuracies due to speed sensing are included.</p> <table border="1"> <thead> <tr> <th>ACTUAL VEHICLE SPEED</th> <th>INDICATED SPEED</th> </tr> </thead> <tbody> <tr> <td>0 TO 120 MPH</td> <td>+/- 2 MPH</td> </tr> </tbody> </table> <p><i>The speedometer calibration is for the 6.0L V8 engine, automatic transmission with a 2.92 axle and P235/50R18 tires, and the 3.6L V6 engine, automatic transmission, 2.92 axle and P235/50R18 W-rated tires</i></p>	ACTUAL VEHICLE SPEED	INDICATED SPEED	0 TO 120 MPH	+/- 2 MPH
ACTUAL VEHICLE SPEED		INDICATED SPEED			
0 TO 120 MPH		+/- 2 MPH			
<p>DISTANCE / TIME TO GO (ENTER TRIP DISTANCE AT START OF TRIP; CAN BE TURNED ON OR OFF)</p>					
<p>RANGE (BASED ON RECENT AVERAGE FUEL ECONOMY)</p>					

9C1 POLICE PACKAGE PPV – SHIFT LEVER

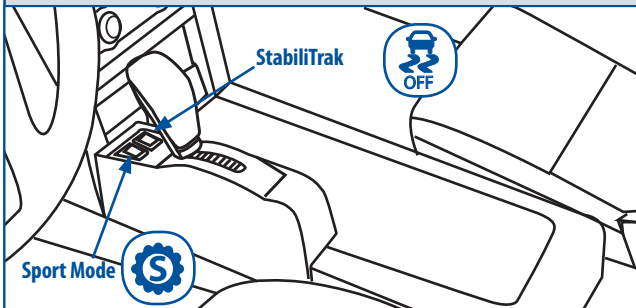

The offset shift lever is located on the floor adjacent to the driver. 10 inches of open space between seats for aftermarket supplied equipment.

The transmission can be placed into Sport Shift Mode by pressing the Sport Mode button in front of the shift lever. The message SPORT MODE will appear momentarily in the DIC to indicate that Sport Mode has been selected. A small, fixed message will appear at the bottom of the DIC display with the text and will remain while the Sport Mode is engaged. When operated in the Sport Shift Mode, the transmission will delay up-shifts and allow earlier down-shifts. In addition, the transmission can sense enthusiastic driving and may delay up-shifting and down-shifting earlier when braking. This operation is designed to maximize vehicle performance. To return to Normal Shift Mode, press the Sport Mode button again. The message NORMAL SHIFT will be displayed in the DIC. Normal Shift Mode is recommended for normal highway or freeway driving as it provides optimum fuel economy. Refer also to the Owner's Manual.

Pushing the StabiliTrak button turns OFF Traction Control and places StabiliTrak in Performance Mode, permitting more aggressive driving before StabiliTrak will engage. Push the button again to reactivate normal StabiliTrak operation.

9C3 DETECTIVE POLICE PACKAGE – SHIFT LEVER

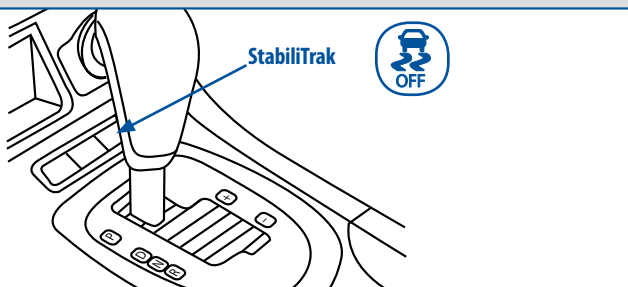

The shift lever is located in the center console between the front seats.

The transmission can be placed into Sport Shift Mode by moving the shift lever over from Drive (D) to the RH side of the shift quadrant. The message SPORT MODE will appear momentarily in the DIC to indicate that Sport Mode has been selected. A small, fixed message will appear at the bottom of the DIC display with the text and will remain while the Sport Mode is engaged. When operated in the Sport Shift Mode, the transmission will delay up-shifts and allow earlier down-shifts. In addition, the transmission can sense enthusiastic driving and may delay up-shifting and down-shifting earlier when braking. This operation is designed to maximize vehicle performance. To return to Normal Shift Mode, slide the shift lever from the RH side into Drive (D) at the LH side of the quadrant. The message NORMAL SHIFT will be displayed in the DIC. Normal Shift Mode is recommended for normal highway or freeway driving as it provides optimum fuel economy.

The 9C3 (only) Sport Shift Mode also includes Active Select Mode to permit manual shifting of the transmission. Refer also to the Owner's Manual.

Pushing the StabiliTrak button turns OFF Traction Control and places StabiliTrak in Performance Mode, permitting more aggressive driving before StabiliTrak will engage. Push the button again to reactivate normal StabiliTrak operation.

OFFSET SHIFT LEVER CONSOLE DIMENSION

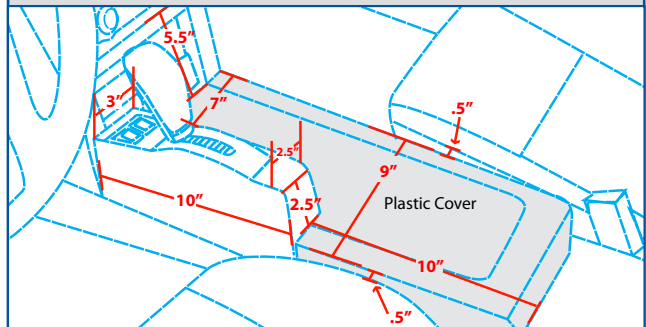

Approximate dimensions for center console area with offset shift lever.

CAUTION: Do not mount aftermarket equipment to plastic cover, remove cover for mounting equipment.

WIRING PROVISIONS FOR 12-VOLT BATTERY POWER SUPPLY

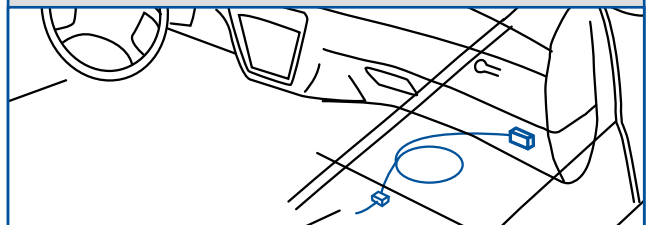

Police relay outputs and control circuit connections are located under the right end of the instrument panel in a 5-foot (1.5 m) coil. Battery power is supplied through two Pre-fuse Assembly fusible links. If the optional auxiliary battery (K45) is not present, power to the Pre-fuse Assembly is supplied by the Primary battery. Three circuit breakers and two control relays are located in the right rear compartment relay center. The relay center is connected via the body harness to the front compartment customer connections. A 50-amp circuit breaker feeds power directly from the 100-amp fusible link via a 10-gauge (5.0mm²) wire. Two 30 amp circuit breakers supply power from fusible links through the contacts of the control relays to 12-gauge (3.0 mm²) wires. Each relay is operated by control leads in the 5-foot coil in the front compartment. An 8-gauge ground lead is also provided in the coil. A total of 1320-watts of 12-volt power is available in the front compartment. 1440-watts of 12-volt power is available at the rear compartment junction block.

Note: If 50 amp battery power is not present at the front compartment upfitter harness, verify the connection of the topmost (blue) of two connectors located above the right hand rear compartment junction block. See also page 16, Rear Auxiliary Power and Ground Stud, page 20 K45-Auxiliary Battery and page 26, Wiring Diagram.

ENGINE OIL COOLER

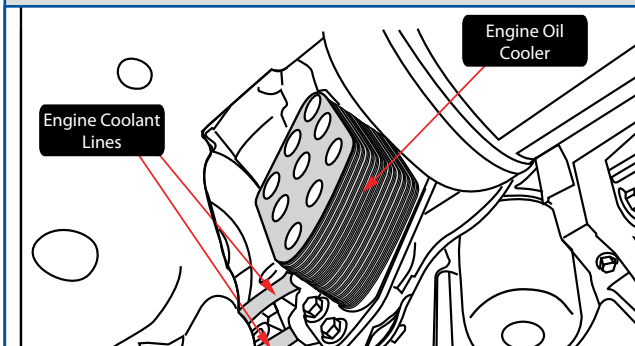

The oil-to-coolant engine oil cooler system is mounted on the left side of the lower engine block forward of the oil filter. Engine oil flows through the stacked plate cooler from the engine oil sump and returns. Coolant flows from the cooler from the engine block and returns to the radiator through a connection to the radiator inlet hose.

Note: only available on the V8 engine as is not required on V6 engine

TRANSMISSION AND POWER STEERING OIL COOLERS

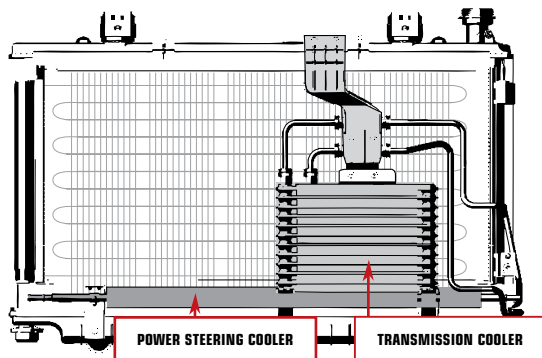

The transmission cooler is positioned to the right side, behind the engine coolant radiator (viewed from the passenger front seat) and the power steering cooler is a separate unit, located along the front bottom of the air conditioning condenser. The cooling system is common to the V6 and V8 engines.

TIRE PRESSURE MONITOR SYSTEM

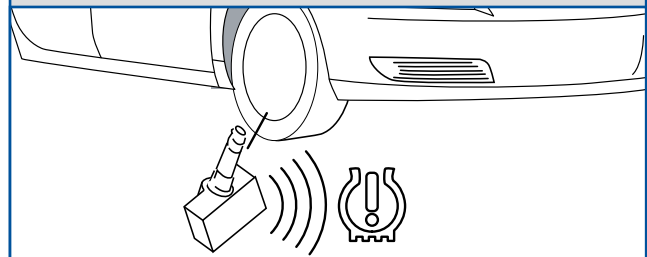

Your vehicle is equipped with a Tire Pressure Monitor (TPM) System which warns of low tire pressure. Your Caprice Police Package may be equipped with a full-size spare tire (see page 9) The full-size spare tire has a sensor but the vehicle is not programmed to read the spare tire pressure. When the full-size spare tire from your vehicle or spare tire from another Police Package is placed in use as a road wheel, the system will not read the presence of the new TPM sensor and must be calibrated. Refer to your owner's manual for additional information on the Tire Pressure Monitor and Sensor Programming. The space saver spare tire does not have a tire pressure monitor.

WIRING PROVISIONS FOR 12-VOLT BATTERY POWER SUPPLY

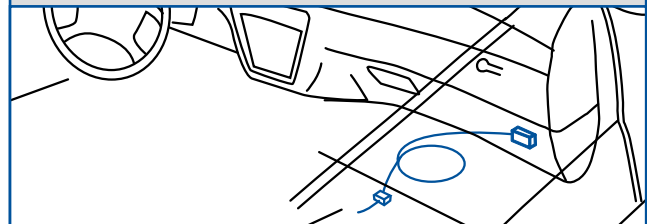

Police relay outputs and control circuit connections are located under the right end of the instrument panel in a 5-foot (1.5 m) coil. Battery power is supplied through two Pre-fuse Assembly fusible links. If the optional auxiliary battery (K45) is not present, power to the Pre-fuse Assembly is supplied by the Primary battery. Three circuit breakers and two control relays are located in the right rear compartment relay center. The relay center is connected via the body harness to the front compartment customer connections. A 50-amp circuit breaker feeds power directly from the 100-amp fusible link via a 10-gauge (5.0mm²) wire. Two 30 amp circuit breakers supply power from fusible links through the contacts of the control relays to 12-gauge (3.0 mm²) wires. Each relay is operated by control leads in the 5-foot coil in the front compartment. An 8-gauge ground lead is also provided in the coil. A total of 1320-watts of 12-volt power is available in the front compartment. 1440-watts of 12-volt power is available at the rear compartment junction block.

SERVICE PARTS IDENTIFICATION LABEL

SERVICE PARTS IDENTIFICATION DO NOT REMOVE

6G1MK5T22BL532613										PDBJCH		1EW19	
AGK	AG2	AL0	AMF	AP3	AR9	AT8	AXJ	AY0	A75	A76			
BDR	B3B	B42	B86	B9V	C67	DK2	EF7	E2C	FE9	FR9			
IPG	JA9	JL9	KD1	KG4	LGD	MX0	M15	NK5	NT7	N99			
OST	QPP	R7V	R9N	R9Z	SLM	T53	UH8	UJM	UN9	UT7			
UW6	UIC	U77	VT7	V8D	WL9	ZFH	1SZ	GAN	4BB	191			
3FL	6A3	6E2	6HP	6J1	6J3	6J4	6J7	7B3	7HP	7M9			
7X6	8MZ	9C1	9MZ										
BC/CC		U 636R											

A Service Parts Identification (SPID) Label provides Vehicle Identification Number (VIN)-specific Option Code content list, Engineering Model Number (Nameplate, body style), Exterior paint system, Exterior paint color code and Interior trim level and color. The SPID label for the Caprice is located on the underside center area of the spare tire cover. The rear compartment trim must be lifted to access the label.

KEYLOCK CYLINDER - TRUNK LID

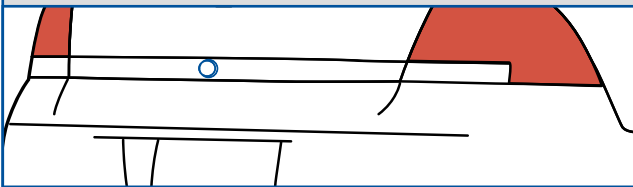

If your vehicle is equipped with Remote Start, a Content Theft Deterrent System is included; an audible alarm will occur when the ignition key is used to open the trunk instead of the Remote Keyless Entry (key FOB).

EXTERIOR LAMPS CONTROL

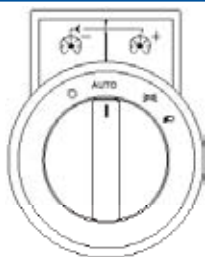

VVS – Delete Daytime Running Lamps and Automatic Headlamps. This option disables the Daytime Running Lamps and Automatic Headlamps control feature. Exterior lamps are manually controlled only. Option VVS is not available in Canada. The headlamp control on the driver's side of the instrument panel operates the headlamps.

If your Caprice does not have option VVS, Daytime Running Lamps and Automatic Headlamps Delete, the Daytime Running Lamps and Automatic Headlamps can be turned off for one ignition cycle by rotating the control knob momentarily counter-clockwise. Rotating the headlamp switch again will turn the daytime running lamps or automatic headlamps back on.

In Canada, the Daytime Running Lamps and Automatic Headlamps can be turned off if the transmission is in Park. See also Caprice owner's manual.

REAR AUXILIARY POWER AND GROUND STUD

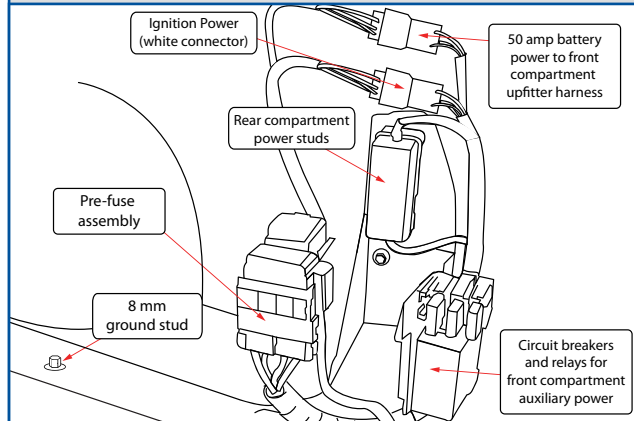

An auxiliary power junction block is located at the right side of the rear compartment. The junction block is at the rear of the auxiliary battery tray and contains a split bus with two terminals for customer connection to 12-volt battery power.

The split bus is connected to the primary battery located at the left side of the rear compartment. When the optional auxiliary battery (RPO K45) is present, the split bus is connected to the auxiliary battery through an isolation relay.

Two 60-amp fusible links connect the bus to the battery. Maximum combined capacity of the two circuits is 1440-watts.

An 8 mm ground stud for customer connection is located at the inboard front corner of the right side battery tray.

A Pink/Blue ignition controlled power circuit, HOT in RUN/START, terminates in a white connector located above the auxiliary battery power junction block. This same circuit is also located in the front passenger foot well upfitter harness (see page 23). A 10 Amp fuse (F38) protects both circuits and is located in the engine compartment fuse center. The total power available for the combined front and rear circuits is 60 watts.

DOME LAMPS CONTROL

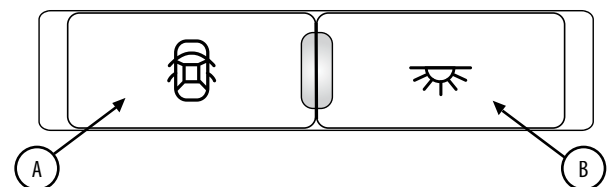

Buttons are located in front dome lamp assembly

A – The push on/push off left switch with a Doors Open symbol on the front dome lamp assembly controls the front and rear dome lamps. When activated, the dome lamps will remain Off whenever:

- any door is opened,
- the vehicle is unlocked, or
- the key is removed from the ignition switch.

B - The push on/push off right switch with a Dome Lamp symbol on the front dome lamp assembly turns the front and rear dome lamps On and Off.

WIRING PROVISION FOR FRONT SPEAKERS – OPTION WX7

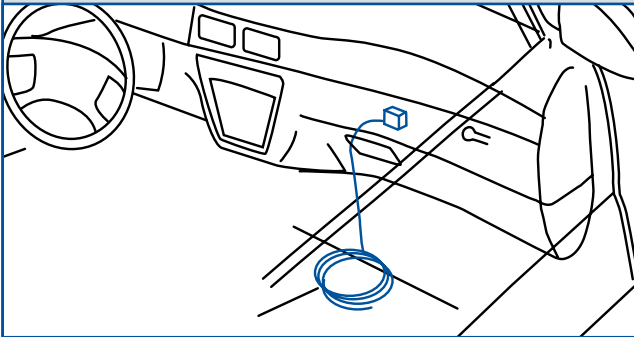

Approximately 60 inches (1.5 m) of auxiliary speaker wiring is routed from the front door and windshield pillar speakers and coiled under the instrument panel. The wiring permits connection of the front speaker pairs to customer-installed communication equipment. Vehicle radio front speaker outputs are re-routed to the rear speakers to maintain the required open door/key-in-ignition audible warning.

6J3 WIRING - GRILLE LAMPS, SPEAKER

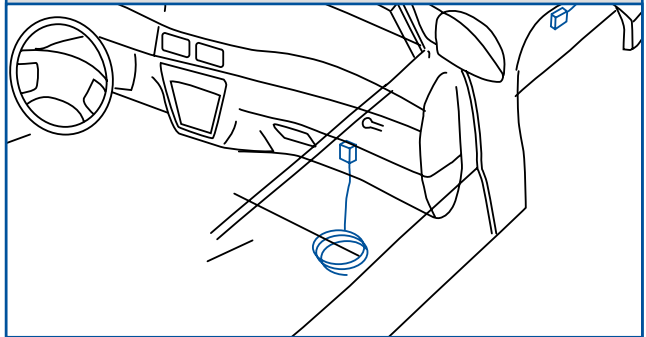

The SEO 6J3 wiring provision has a 60-inch (1.5 m) harness coiled underneath the instrument panel on the passenger side. The wiring circuits are routed from under the instrument panel to a 2-foot (610 mm) coil secured in the area behind the grille, to the left of the hood latch assembly.

6J4 WIRING - HORN/SIREN CIRCUIT

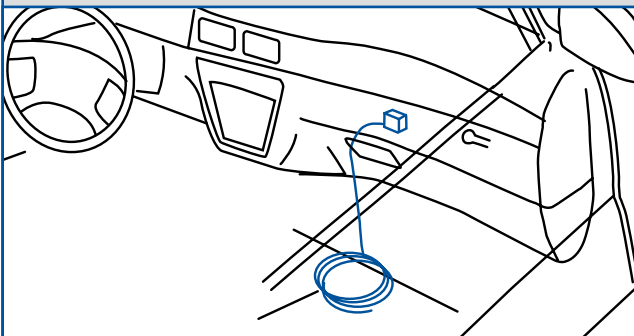

Two 16-gauge wires are connected to an in-line connector in the horn circuit of the instrument panel harness under the instrument panel. The end of this harness extension is terminated with an in-line connector in a 60-inch (1.5 m) coil under the instrument panel. Connection to customer switching permits operation of the horn or siren with the horn button.

6C7 LAMP - AUXILIARY DOME

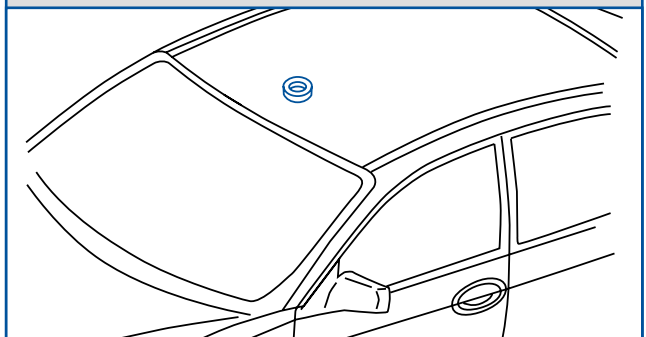

Auxiliary dome lamp is located to the rear of the vehicle dome lamp. The auxiliary lamp is wired independently from the standard dome lamp.

B42 MAT - TRUNK

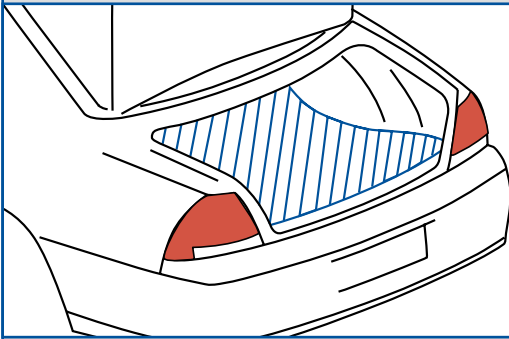

Custom fitted, heavy-duty vinyl molded edge to keep spills contained, removable for easy cleaning

T53 LAMPS - TRUNK LID WARNING

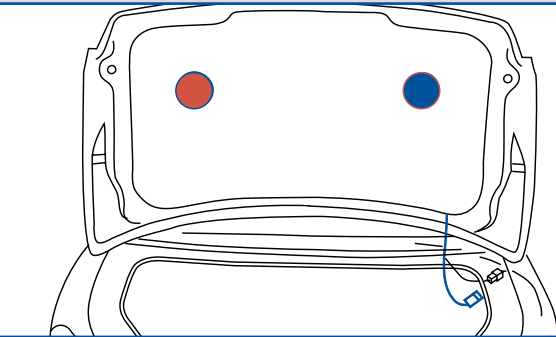

Two 4-inch, single faced, red and blue LED lamps are mounted to the deck lid inner panel. Lamps are activated by the deck lid ajar mechanical switch when deck lid is opened. Lamps are wired to flash alternately through a flasher located at the upper right hand corner of the trunk opening.

Wiring is protected by fuse F8 in the rear fuse block located on top of the standard battery in the trunk.

6A3 COVERING - FLOOR

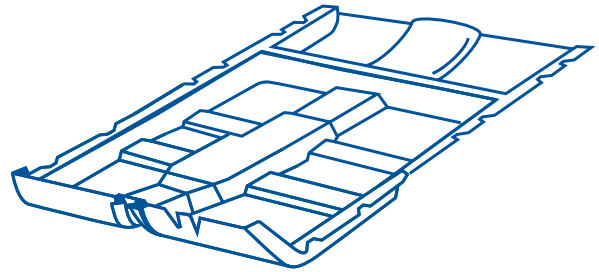

Black heavy-duty front and rear. Replaces production carpeting.

AUTONET MOBILE WIFI; IN-CAR ROUTER



Delivers high speed network connectivity to vehicles by leveraging the 3G network. Autonet Mobile's TRU Technology, a proprietary and patented technology, provides a seamless connection regardless how fast you are traveling. Unlike conventional cellular data technology, TRU Technology manages data as users travel at high speeds between cell towers, eliminating dropped connections. CarFi™ provides wireless device connectivity within the vehicle using standards-based 802.11 Wi-Fi networking. This allows users in and around the vehicle to access the Internet using any Wi-Fi enabled device. Available through your GM dealer.

SG8 FULL SIZE SPARE

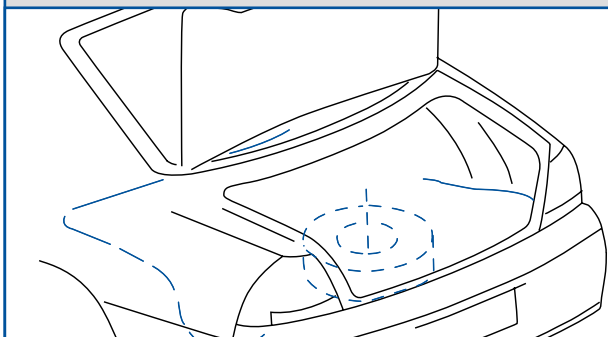

Full-size spare tire is mounted under the load floor. The full-size spare tire includes a Tire Pressure Monitor (TPM) sensor which must be programmed to the TPM System after the spare tire is installed.

7Y6 LAMP - INOPERATIVE DOME

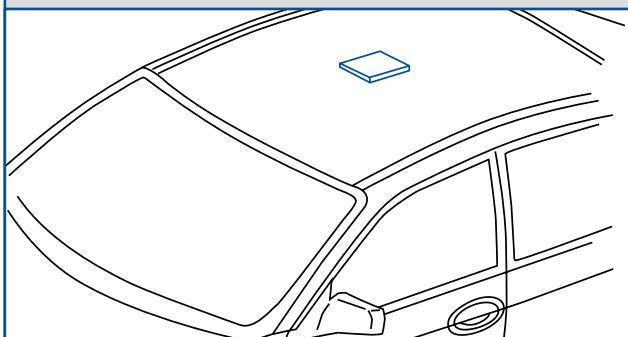

Dome and courtesy lamps will not operate when doors are opened. Front and rear dome lamps are controlled only by the switch at the front dome lamp console.

6J7 FLASHING SYSTEM, EXTERIOR LAMPS, HEADLAMPS, TAIL LAMPS AND BACKUP LIGHTS

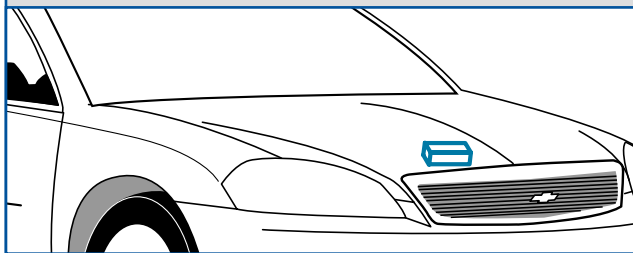

HEADLAMPS

This option provides a flashing module, headlamp alternate high beam flashing, rear alternate flashing of the stop and backup lamps and a control wire for connection a customer furnished ON/OFF switch. A second control wire permits optional separate control of headlamp flashing and rear lamps flashing via customer switching.

The headlamp flashing module is located at the rear edge of the passenger side upper radiator support. The headlamp flashing module is activated by application of 12-volts to a dark green/red wire coiled in the right front footwell. When activated, the left and right high beams and the high beam instrument cluster telltale will flash alternately at 2.4 flashes per second.

During daylight conditions, the Daytime Running Lights (DRL) are automatically deactivated whenever the headlamp flasher module is activated; during nighttime conditions, the low beams are automatically on while the high beams flash (unless option VVS is present). Activating the high beam switch will override the flashing mode and the high beams will operate continuously.

A 15-amp fuse (F16) protects the front flasher circuit and is located in the engine wiring harness junction block at the right side of the engine compartment.

TAIL LAMPS AND BACKUP LAMPS

When the headlamp flashing module is activated the body control module will cause the left and right stop lamps to flash alternately with the backup lamps at a rate of 2.4 flashes per second. The center high-mounted stoplamp does NOT flash and operates only with application of the service brakes. During nighttime conditions, the tail lamps are automatically ON (unless option VVS is present).

Activation of the headlamp and rear lamp flashing can be separated by opening the dark blue and yellow control circuit at the underhood inline module connector and application of a customer provided switched ground to the control wire under the right instrument panel.

6N5 SWITCHES - REAR WINDOW INOPERATIVE

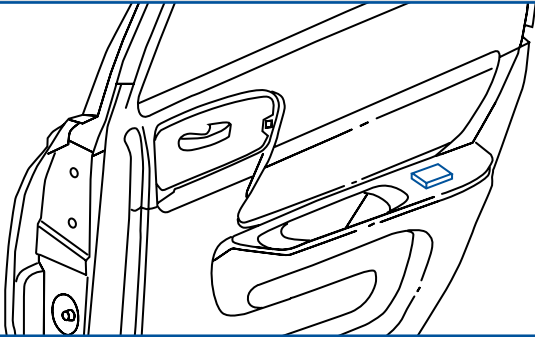

Rear door window switches are inoperative. Rear door power regulators are operable only from driver position switches.

6N6 - REAR DOOR LOCKS AND HANDLES INOPERATIVE

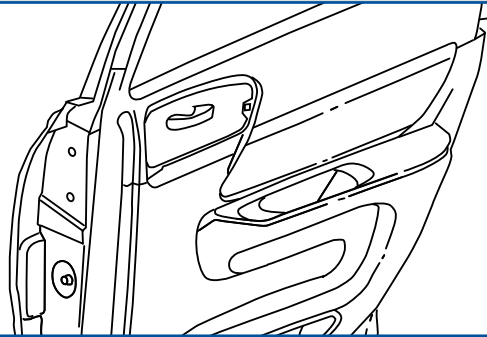

Rear doors can only be opened from the outside.

K4S – AUXILIARY BATTERY

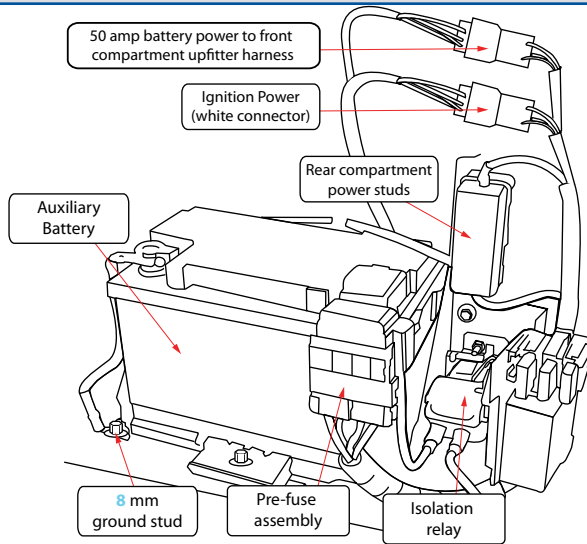

Option K4S, Auxiliary Battery, consists of a 600 cca battery mounted at the right side of the rear compartment and is connected to the electrical system via a Pre-fuse Assembly. Also included is an isolation relay which is activated whenever the ignition is ON. The isolation relay is intended to isolate the auxiliary battery and connected load from the primary battery to avoid unintended rundown of the primary battery. Whenever the ignition is ON and the engine is running, the primary battery and auxiliary batteries are being charged, as determined by the charging system controls.

A Pink/Blue ignition controlled power circuit, HOT in RUN/START, terminates in a white connector located above the auxiliary battery power junction block. This same circuit is also located in the front passenger foot well upfitter harness (see page 14 or page 27). A 10 Amp fuse (F38) protects both circuits and is located in the engine compartment fuse center. The total power available for the combined front and rear circuits is 60 watts.

AMF - PACKAGE OF 6 KEY/TRANSMITTERS

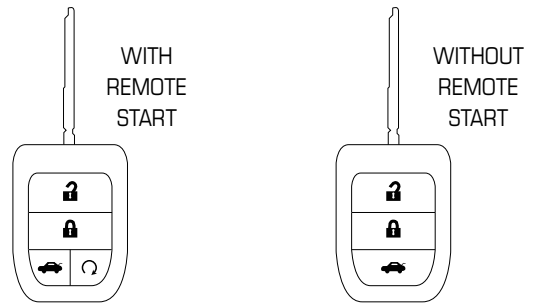

NEW KEY LEARN PROCEDURE

1. The six RPO AMF keys are pre-cut at vehicle assembly. If a key is separate from AMF, cut the new key blank to match the vehicle key (master)
2. Using the master key, turn ON the ignition, with the engine OFF
3. Turn OFF the ignition and remove the key
4. Within 10 seconds of turning OFF the ignition, insert the key to be learned and turn ON the ignition. The vehicle has now learned the new key.

REMOTE TRANSMITTER LEARN PROCEDURE

1. Ignition must be ON and transmission in PARK (P)
2. Press the TRIP button until the customization trip page is reached.
3. Press the ENTER button on the enter the customization menu.
4. Scroll down to the 'Remote Key' menu item and press ENTER
5. Scroll down to the 'Program' menu item and press ENTER
6. Press and hold the LOCK and UNLOCK button on the first transmitter at the same time for approximately 15 seconds. 2 beeps will sound indicating the transmitter is matched.
7. Repeat step 6 for the additional transmitters.
8. To exit the programming mode, key the ignition to OFF.

Note: A maximum of 8 keys may be learned for a vehicle immobilizer (Passkey III+) with a random key code. Vehicles with the fleet key option (RPO 6E3 or 6E4) may have more than 8 keys learned for the particular option fleet key and must be learned using one of the original "master" keys. When programming RPO AMF additional 6 remote transmitters, the original 2 transmitter delivered with a vehicle must also be reprogrammed at the same time.

Can specialty vehicle equipment (e.g. radar devices, video cameras, computers, meters, radio trees, shotguns, etc.) still be mounted in cars with passenger side air bags?

Yes, but care must be taken to mount the equipment outside of the deployment zone. Air bags inflate with great force and will interact with any object in the deployment zone. Therefore, to reduce the risk of injury to vehicle occupants, GM recommends that the air deployment zone be kept free of any equipment. If a piece of equipment were to become dislodged it could strike an occupant in the vehicle and result in injury. The likelihood of an object becoming dislodged is influenced by many factors, including the proximity of the object to the inflatable restraint, the size and shape of the object, and the means by which the object is secured to the vehicle. In addition to these factors, the trajectory and velocity of a dislodged object can be influenced by the type and severity of vehicle crash.

Objects that are in the deployment zone, but do not become dislodged by an inflating air bag can still affect the performance of the air bag. For example, such objects could tear the fabric or affect the shape of the air bag, thus reducing the ability of the bag to provide restraint.

Is it possible to shield equipment that is installed in the passenger side frontal air bag deployment zone in a manner that will allow full and safe air bag deployment?

Due to the complexity of influencing variables, GM is unable to evaluate the potential for shielding expected equipment configurations in all accident scenarios in order to assure that the air bag performance would be unaffected. While shielding may protect certain equipment from being damaged or dislodged, it may also negatively affect the inflation characteristics of the air bag. The air bag's shape, inflation angle, fold pattern, and inflation rate and pressure are developed to maximize the protection capability of the inflatable restraint system. Therefore, GM cannot recommend the placement of any equipment in the deployment zone, even if it is shielded to protect it from damage.

Front air bag systems and instrument panel mounted equipment.

Passenger air bags in GM vehicles deploy in different ways depending upon the type of vehicle and the particular instrument panel design.

In some vehicles, the passenger air bag deploys through a discrete door located on the top surface of the instrument panel (top-mount air bag systems). In other vehicles, such as the Chevrolet Tahoe, the passenger air bag deploys through a discrete door mounted on the vertical rearward surface of the instrument panel, above the glove box door (mid-mount air bag system). With these types of top-mount and mid-mount passenger air bag systems, the top pad of the instrument panel remains in place during deployment.

Some GM passenger air bag systems, like the system in the Chevrolet Impala, deploy from beneath the instrument panel top pad. These are considered 3/4-mount air bag systems with a "deployable top pad." The entire instrument panel top pad is the "deployment door" from under which the inflating air bag emerges. When an air bag deployment is commanded, the forces from the inflating passenger air bag push up on the instrument panel top pad, releasing special fasteners across the rearward edge of the top pad. This allows the top pad to rotate upward so that the passenger air bag may emerge. The top pad rotates upward to open widest at the right hand side, and is usually forced upward into contact with the windshield on the right hand side of the vehicle during a deployment.

Head curtain side air bags are designed to help reduce the risk of head and neck injuries to front and rear seat occupants on the near side of certain side-impact collisions. Always use safety belts and the correct child restraints for your child's age and size, even in vehicles equipped with air bags. Children are safer when properly secured in a rear seat. See your vehicle Owner's Manual and child safety seat instructions for more information.

Instrument panel top mounted special equipment, such as a radar antenna and control unit or video camera must be positioned to the left of the vehicle center line. This equipment must be mounted as low as possible and securely fastened to the top pad to avoid being dislodged in the event of a crash and possible air bag deployment. In the process of securely fastening special equipment to the top, DO NOT fasten down the top pad itself to any other vehicle component such as the cluster trim plate. As described above, the top pad rotates upward during a deployment. In order to enable the proper deployment of the passenger air bag, specialty equipment installation MUST NOT PREVENT the top pad from rotating upward during deployment. Location and attachment of special equipment should minimize added resistance or interference to upward rotation of the top pad during deployment.

Optional side air bags for crashes to the vehicle sides.

The air bag system in your police vehicle may include optional side air bags for front and rear occupants. Most front-to-rear side air bags are designed to deploy downward from the interior roof sides to the bottom of the door windows.

Can Specialty Vehicle Security Barriers be mounted within the side air bag deployment zones?

No. The side air bags inflate extremely fast because of the nature of side crashes to the vehicle. Mounting a security barrier behind the front seats with the ends placed within the side air bag deployment zones will result in unintended interaction between the barrier and the inflating side air bags. To reduce the risk of injury to the vehicle occupants, GM recommends that the side air bag zones be kept free of any customer installed equipment.

Customer furnished equipment installed to the vehicle roof.

Your police vehicle is designed with an interior roof cover system which includes internal components for the interior lamps and wiring. The roof system may also include optional side air bag components. Inflation devices may be mounted on the vehicle roof side behind the rear doors as well as air bag tethers retained to the windshield pillars. Care must be taken to avoid damage to these components or interference with their operation when installing roof mounted equipment such as emergency lamps and communication antennas.

Recommended GM service procedures must be followed to remove and re-install the instrument panel top pad to ensure that the top pad will release properly in the event of a passenger air bag deployment.

On the right half of the top pad closest to the passenger air bag module, GM recommends that no equipment be mounted. When mounting equipment on the driver side of the top pad, GM recommends that the total mass of the top pad mounted special equipment not exceed 8 pounds (3.6 kilograms), since the top pad tends to rotate about the left end.

Fasteners used to secure special equipment to the instrument panel top pad, the windshield glass, or to the windshield upper frame (header), should be selected to ensure that these devices will remain attached during a vehicle crash and possible air bag deployment.

Can the installation of push bumpers on the front end of the vehicle affect the deployment of the air bag?

General Motors is not aware of adverse effects during crash events from the many push bumpers that have been installed on GM police vehicles. Because there are many styles of push bumpers available with varying crash characteristics, installation of push bumpers may or may not affect deployment timing of the air bags. Push bumpers should be mounted to avoid modifying the vehicle structure and interfering with the front air bag sensors mounted on the upper radiator support cross member.

Two front impact sensors are installed in General Motors vehicles. Do not relocate or disconnect the front sensors. The location and orientation of the front sensors are critical for correct operation of the air bag system. Avoid mounting components on or near the sensors. Push bumper styles with vertical pushing members that are in fore-aft alignment with the front air bag sensors are not recommended.

How long will the air bag remain inflated?

It takes approximately 1/20th of a second to fully inflate the frontal air bags. This is faster than the blink of an eye. The air bags begin to deflate immediately, helping to stop the occupants more gradually.

Can the air bag system be re-used?

No. The air bags are designed to inflate only once. After inflation some new parts will be required. These will include the air bag module and possibly other parts. (A competent service technician with access to the vehicle's service manual and the required tools should replace the required components after a deployment crash.)

I've heard that the dusts that are released into the passenger compartment from the air bag are harmful. Is this true?

For most people, the only effect the dusts will produce is some irritation of the throat and eyes, and that is only if the occupant remains in the vehicle for many minutes after the air bag deployment with no ventilation and windows closed. However, some people with asthma may develop an asthmatic attack from inhaling the dusts. If this happens, they should first treat themselves the same way their doctor has advised them to treat any other asthma attack, and then immediately seek medical treatment.

When should an air bag inflate?

The driver's and right-front passenger's frontal air bags are designed to inflate in moderate to severe frontal or near-frontal crashes. But they are designed to inflate only if the impact speed is above the system's designed "threshold level."

In addition, if your vehicle has "dual stage" frontal air bags, these air bags tailor the amount of restraint according to crash severity. For moderate frontal impacts, the air bags inflate at a level less than full deployment. For more severe frontal impacts, "dual stage" frontal air bags deploy at full levels.

If the front of your vehicle goes straight into a wall that doesn't move or deform, the threshold level of the reduced deployment is about 12 to 16 mph (19 to 15 km/h), and the threshold level for a full deployment is about 18 to 24 mph (29 to 28.5 km/h). The threshold level can vary, however, with specific vehicle design, so that it can be somewhat above or below this range.

If your vehicle strikes something that will move or deform such as a parked car, the threshold level will be higher. The driver's and right-front passenger's frontal air bags are not designed to inflate in rollover, side impacts, or rear impacts, because inflation would not help the occupant.

Seat mounted side impact air bags are designed to inflate in moderate to severe side crashes. The side impact air bags will inflate if the crash severity is above the designed "threshold level." The threshold level can vary with specific vehicles design. The side impact air bags are not designed to inflate on frontal or near-frontal impacts or rear impacts, because inflation would not help the occupant.

Roof rail mounted head-curtain air bags are designed to inflate in moderate to severe side crashes. In addition, certain vehicles have head-curtain air bags which are also designed to inflate in situations where an impending rollover condition is identified by the vehicle's rollover sensing system and/or frontal or near-frontal impacts if the crash severity is above the designed "threshold level".

Safety belt pretensioners at the driver and front passenger seat positions are designed to deploy in frontal, near-frontal, side, and rear crashes that exceed the "threshold level" of crash severity to help reduce slack in the safety belt. Safety belt pretensioners will also deploy in impending rollover situations.

I've heard that a deployed air bag produces what appears to be smoke. Is the air bag hot?

After the bag has deployed in a crash, the air bag itself will not be hot to touch. Some components within the air bag module will be hot for a short time. A small amount of smoke coming from a deployed air bag module is normal and should not be cause for concern.

Also, when the nitrogen gas is vented out of the air bag, small particles from inside the bag are also vented into passenger compartment. These airborne particles look like smoke and some particles are deposited as residue on and around the air bag.

If my vehicle has air bags, why should I have to wear my safety belt?

Air bags are in many vehicles today and will be in most of them in the future. But they are supplemental systems only; so they work with safety belts - not instead of them. Every air bag system ever offered for sale has required the use of safety belts. Even if you're in a vehicle that has air bags, you still have to buckle up to get the most protection. That's true not only in frontal collisions but especially in side and other collisions.

Note: All dimensions are approximate and subject to change.

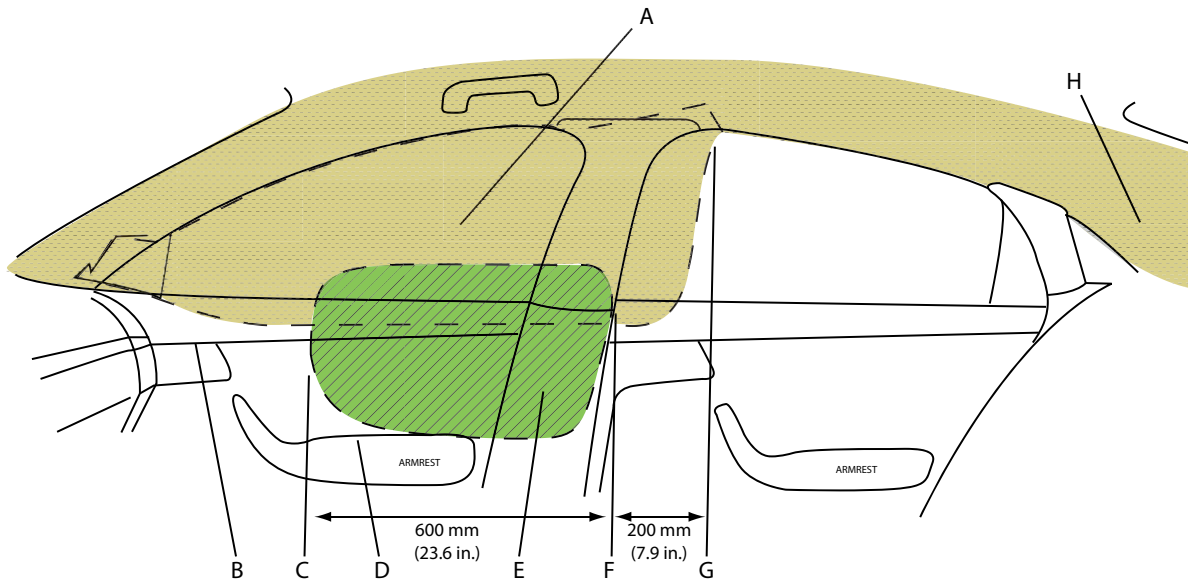

STANDARD HEAD CURTAIN AND FRONT SEAT-MOUNTED SIDE IMPACT AIR BAG¹ DEPLOYMENT ZONES
PASSENGER SIDE SHOWN, DRIVER SIDE SIMILAR

- | | |
|--|---|
| A. Head curtain air bag zone – front seats ONLY | E. Front seat thorax air bag zone |
| B. Top of door handles | F. Back edge of body center pillar trim at bottom of rear door window |
| C. Fore-most end of seat-mounted thorax air bag zone | G. Rear-most end of front head curtain zone |
| D. Top of front door armrest | H. Zone extends into sail panel area |

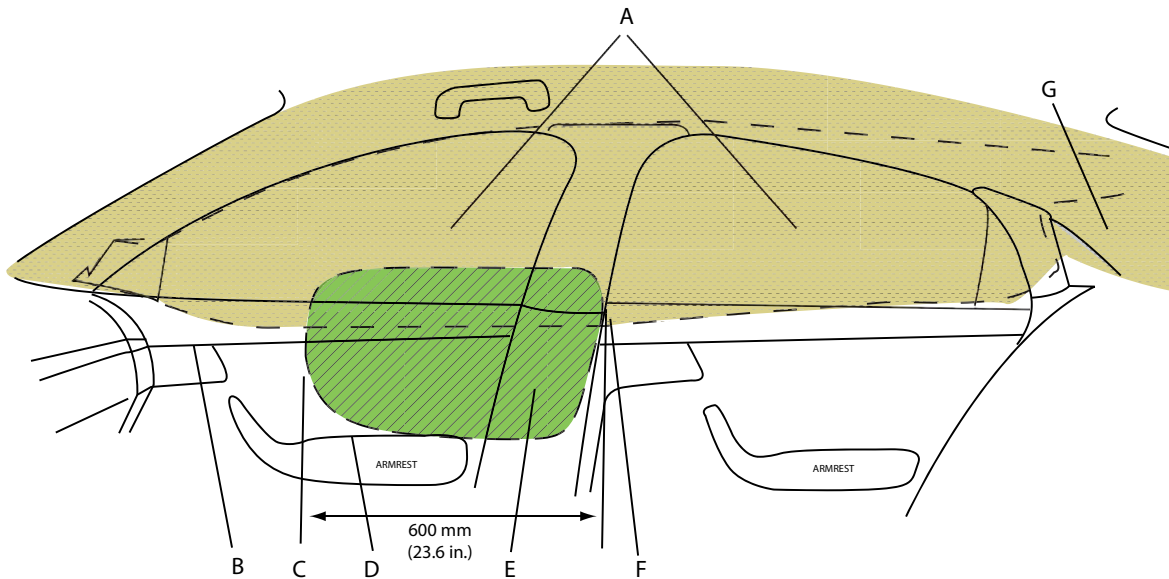

OPTIONAL (RPO AY0) HEAD CURTAIN AND FRONT SEAT-MOUNTED SIDE IMPACT AIR BAG¹ DEPLOYMENT ZONES
PASSENGER SIDE SHOWN, DRIVER SIDE SIMILAR

- | | |
|--|---|
| A. Head Curtain air bag zone – front and rear seats | E. Front seat thorax air bag zone |
| B. Top of door handles | F. Back edge of body center pillar trim at bottom of rear door window |
| C. Fore-most end of seat-mounted thorax air bag zone | G. Zone extends into sail panel area |
| D. Top of front door armrest | |

1. Head curtain side air bags are designed to help reduce the risk of head and neck injuries to front and rear seat occupants on the near side of certain side-impact collisions. Always use safety belts and the correct child restraints for your child's age and size, even in vehicles equipped with air bags. Children are safer when properly secured in a rear seat. See your vehicle Owner's Manual and child safety seat instructions for more information.

24 | CAPRICE POLICE PACKAGE AIR BAGS

Note: All dimensions are approximate and subject to change.

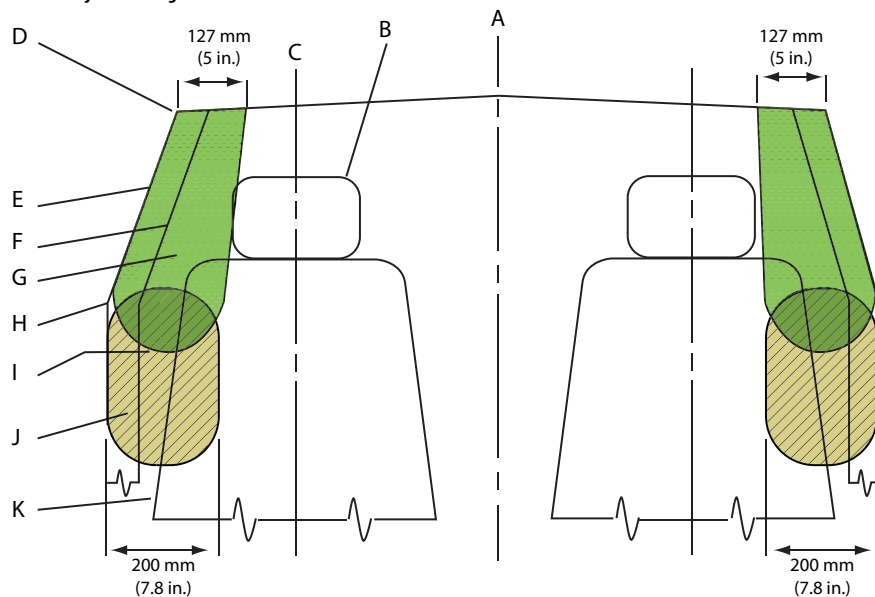

HEAD CURTAIN AND FRONT SEAT-MOUNTED SIDE IMPACT AIR BAG¹ DEPLOYMENT ZONES
VIEW FROM REAR SEAT, RIGHT SIDE IS MIRROR OF LEFT SIDE

- | | |
|----------------------------|--|
| A. Vehicle center-line | G. Head curtain air bag zone |
| B. Headrest | H. Bottom of door windows |
| C. Center-line of occupant | I. Front door handle |
| D. Edge of headliner | J. Front seat back thorax air bag zone |
| E. Door inner trim panel | K. Seat back |
| F. Center body pillar trim | |

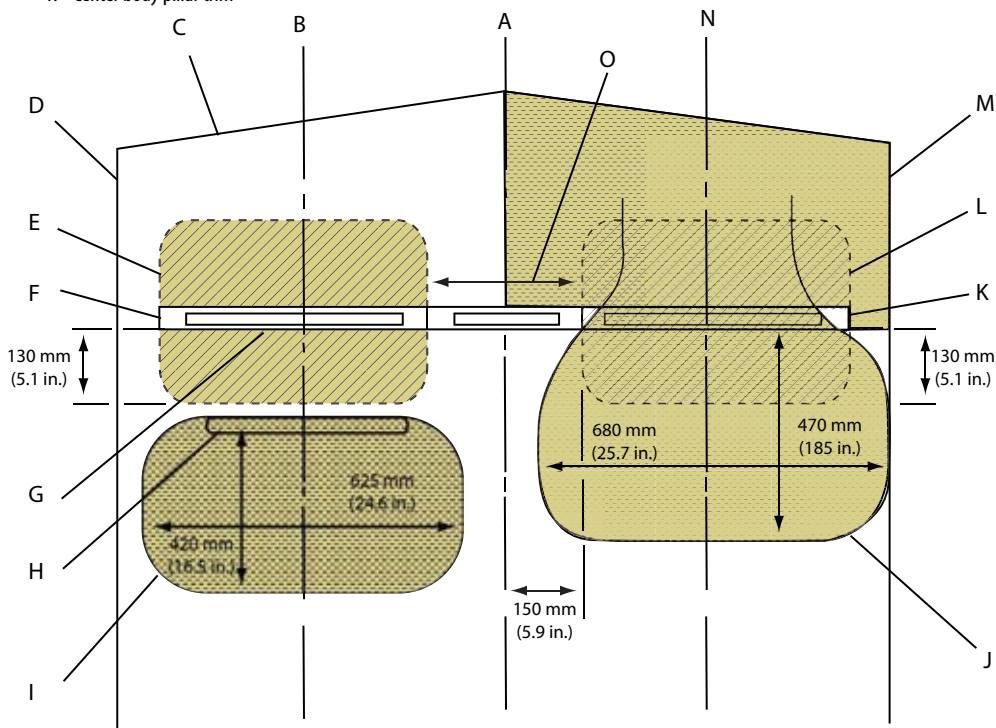

INSTRUMENT PANEL AND APPROXIMATE DEPLOYMENT AREA OF THE DRIVER AND FRONT PASSENGER AIR BAGS¹
VIEW FROM TOP

- | | | |
|---|-------------------------------|---|
| A. Vehicle center-line | F. Instrument cluster | K. Glove box |
| B. Driver center-line | G. Rear-most instrument panel | L. Front passenger knee air bag (model year 2012) |
| C. Front of instrument panel at the windshield base | H. Steering wheel | M. Front passenger door trim |
| D. Driver door trim | I. Driver air bag | N. Front passenger center-line |
| E. Driver knee air bag (model year 2012) | J. Front passenger air bag | O. Radio stack |

1. Head curtain side air bags are designed to help reduce the risk of head and neck injuries to front and rear seat occupants on the near side of certain side-impact collisions. Always use safety belts and the correct child restraints for your child's age and size, even in vehicles equipped with air bags. Children are safer when properly secured in a rear seat. See your vehicle Owner's Manual and child safety seat instructions for more information.

Note: All dimensions are approximate and subject to change.

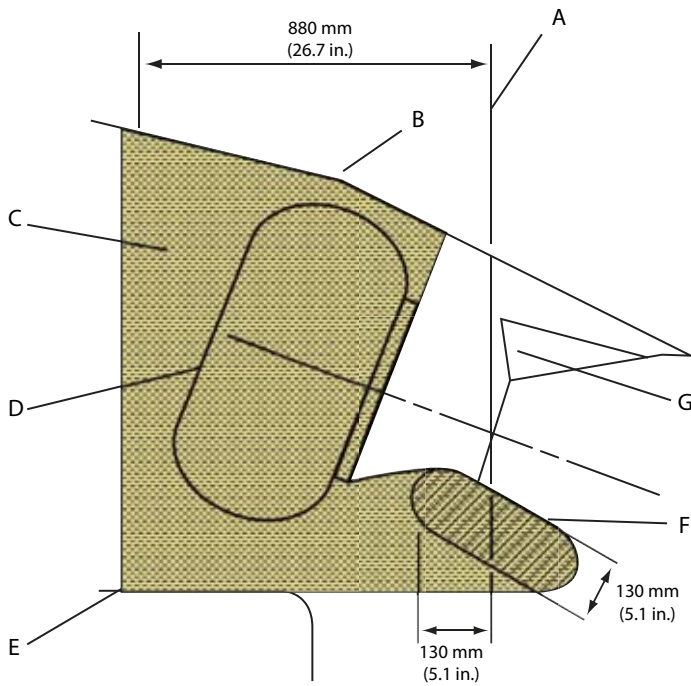

SIDE VIEW OF DRIVER STEERING WHEEL AIR BAG¹
DEPLOYMENT ZONE – CENTER-LINE OF DRIVER
VIEW FROM RIGHT SIDE

- A. Rear-most instrument panel
- B. Top of windshield
- C. Driver air bag zone
- D. Driver air bag
- E. Driver seat
- F. Driver knee air bag (model year 2012)
- G. Instrument cluster

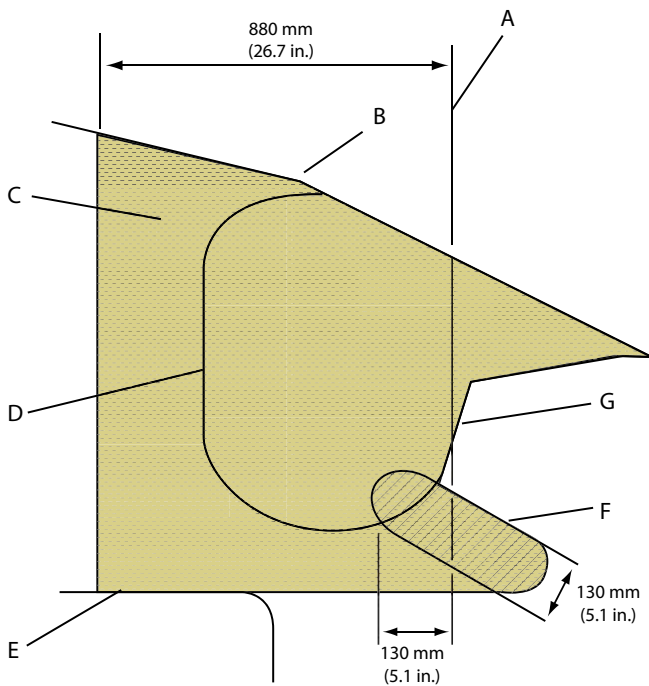

SIDE VIEW OF FRONT SEAT PASSENGER AIR BAG¹
DEPLOYMENT ZONE – CENTER-LINE OF PASSENGER
VIEW FROM RIGHT SIDE

- A. Rear-most instrument panel
- B. Top of windshield
- C. Front passenger air bag zone
- D. Front passenger air bag
- E. Front passenger seat
- F. Front passenger knee air bag (model year 2012)
- G. Glove box door

1. Head curtain side air bags are designed to help reduce the risk of head and neck injuries to front and rear seat occupants on the near side of certain side-impact collisions. Always use safety belts and the correct child restraints for your child's age and size, even in vehicles equipped with air bags. Children are safer when properly secured in a rear seat. See your vehicle Owner's Manual and child safety seat instructions for more information.

WIRING PROVISIONS FOR 12-VOLT BATTERY POWER SUPPLY

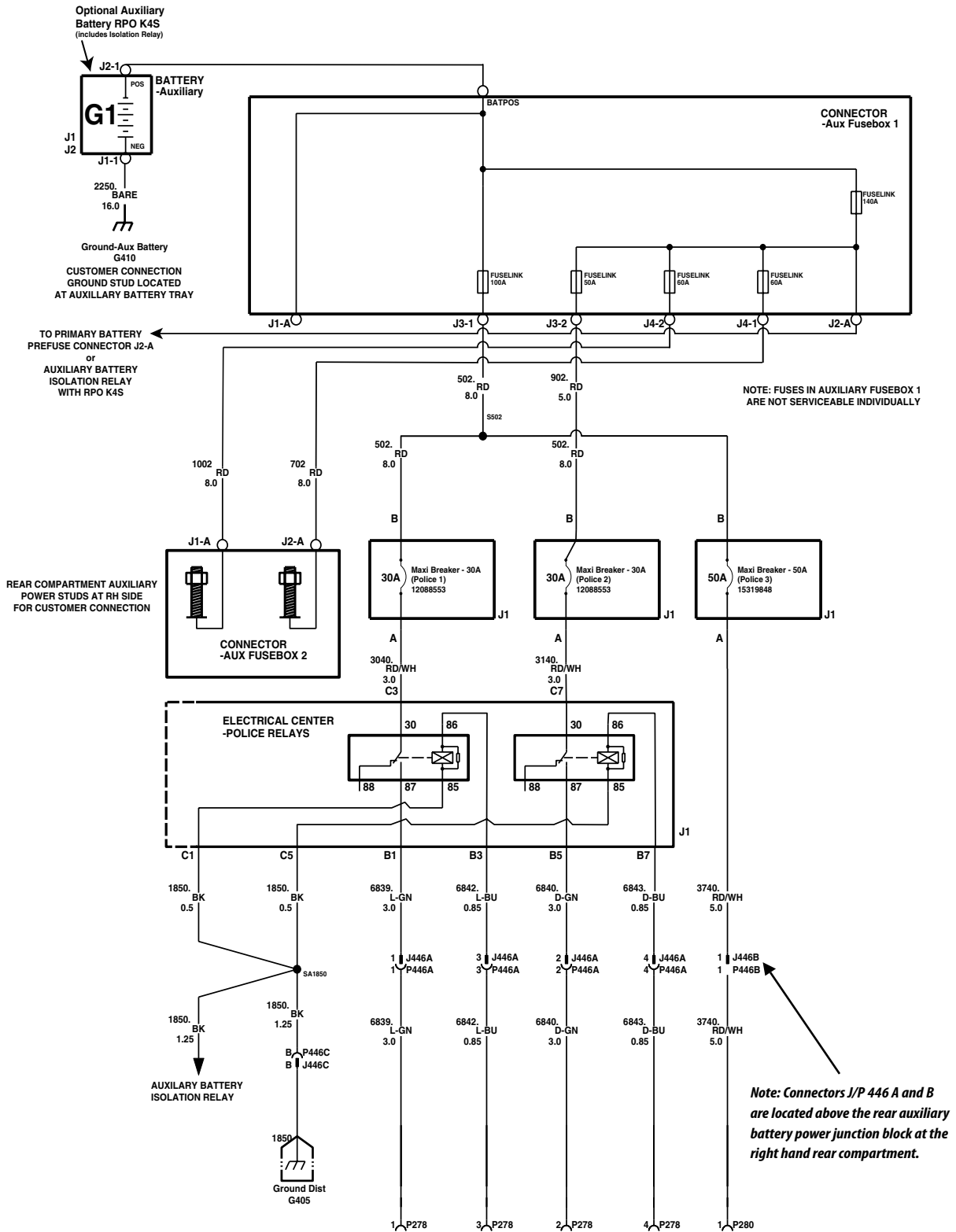

Police relay outputs and control circuit connections are located in right front footwell in a 5-foot (1.5 m) coil. Battery power is supplied through two fusible links, one 100-amp and one 60-amp, to three circuit breakers and two control relays located in the relay center. A 50-amp circuit breaker feeds power directly from the fusible links through a 10-gauge (5.0 mm²) wire. Two 30-amp circuit breakers supply power from the

fusible links through the contacts of the control relays to 12-gauge (3.0 mm²) wires. Each relay is operated by an 18-gauge (0.8 mm²), light or dark blue control lead included in the 5-foot (1.5 m) coil under the instrument panel. An 8-gauge (8.0 mm²) ground lead is also provided in the 5-foot (1.5 m) coil. The total current available through the 12-volt power supply is 110-amperes (1320-watts).

CONTROLLED POWER AND SIGNAL CIRCUITS WITH 12-VOLT POWER SUPPLY

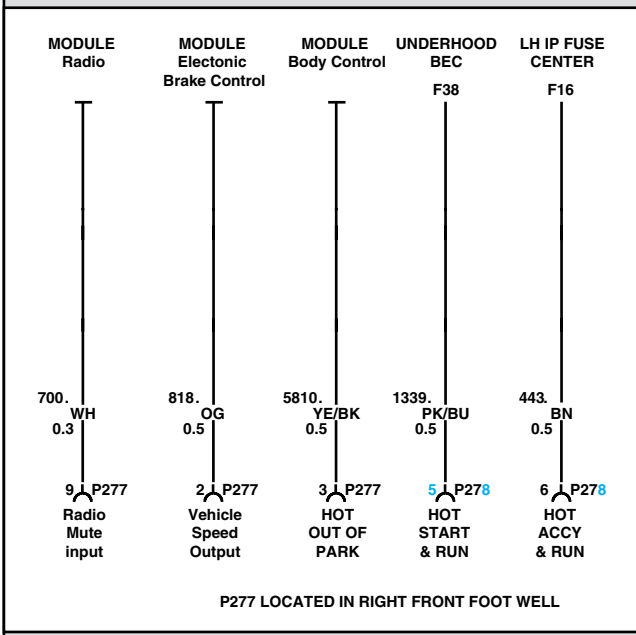

Ignition controlled power and signal circuits are also included in the 5-foot (1.5 m) coiled harness.

- A brown, 20-gauge (0.5 mm²) 10-amp fused circuit, HOT in ACCESSORY/RUN; fuse F16 is in the end of the instrument panel.
- A pink/blue, 20-gauge (0.5 mm²) 10-amp fused circuit, hot in START/RUN. Fuse is in the engine compartment fuse block. This circuit is also located at the RH side of the trunk in a white connector above the rear auxiliary power junction block (See p. 13). Total power available for the combined front and rear circuits is 60 watts.
- A yellow/black, 20-gauge (0.5mm²) park signal from the Body Control Module (BCM). This circuit provides switched power (12-volts) when the transmission is not in PARK (P) and the engine is running. The electrical load attached to the park circuit must not exceed 0.5-amps (one relay coil).
- An orange, 20-gauge (0.5 mm²) vehicle speed signal (4,000 pulses/mile) from the ABS module. Connect only high impedance load.
- A white, 22-gauge (0.3 mm²) radio mute circuit. Mutes radio when grounded.

WIRING PROVISIONS FOR HEADLAMP AND REAR LAMPS FLASHING SYSTEM

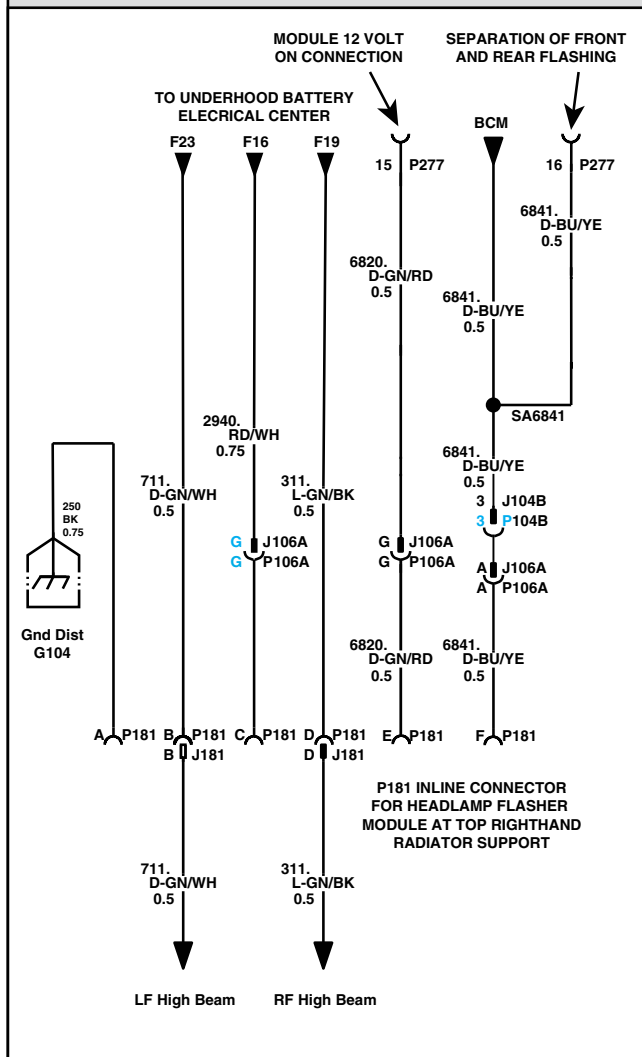

An in-line connector in the forward lamp harness permits installation of a compatible flasher module for the exterior lamps Emergency Flashing System. The in-line flasher module connector is located at the RH end of the upper radiator support and includes two wiring circuits to the front compartment foot well. A dark green with red stripe wire is intended for customer connection to switched 12-volt power to activate the flasher module. A second dark blue with yellow stripe wire permits optional separate control of the headlamp flashing and rear lamps flashing. Separate control of the rear lamps flashing requires opening the dark blue-red control circuit at the in-line module connector and application of switched vehicle ground to the control wire in the forward compartment.

Note: Wiring diagrams for these options are shown in the Police Package owner's manual supplement (shipped in glove box).

WIRING PROVISION FOR HORN/SIREN CIRCUIT - OPTION 6J4

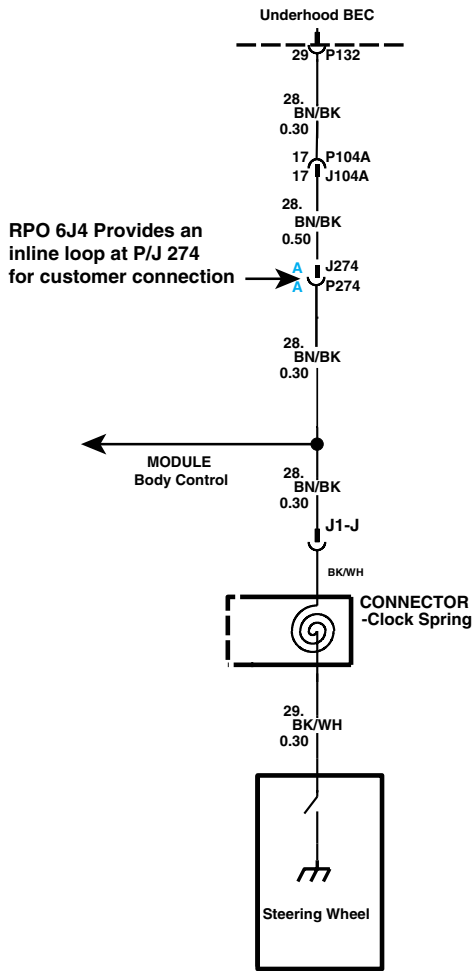

Two 20-gauge (0.5 mm²) wires are connected to an in-line connector in the horn circuit of the instrument panel harness under the instrument panel. The end of this harness extension is terminated with an in-line connector in a 60-inch coil under the instrument panel. Connection to customer switching permits operation of the horn or siren with the horn button.

WIRING PROVISIONS FOR GRILLE LAMPS AND SIREN/SPEAKER - OPTION 6J3

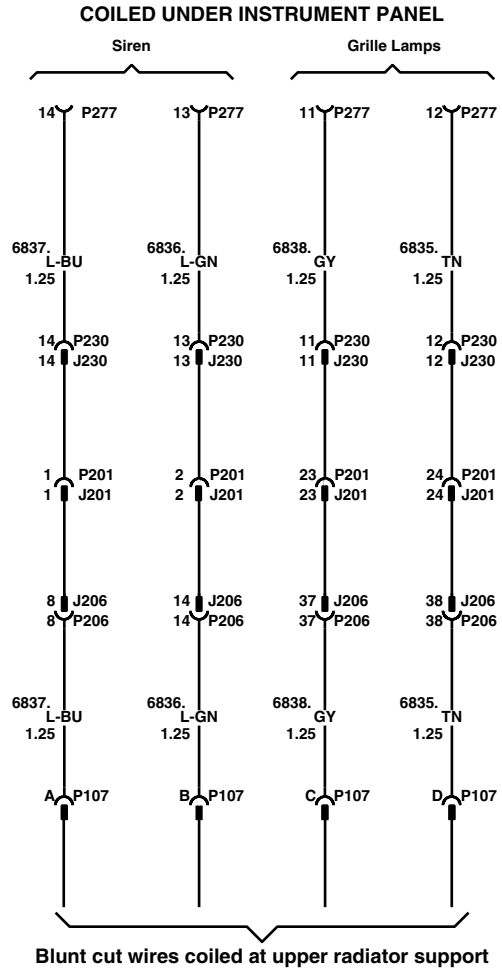

The SEO 6J3 wiring provision has a 5-foot (1.5 m) harness coiled underneath the instrument panel on the passenger side. The wiring circuits are routed from under the instrument panel to a 1-foot (30 cm) coil secured in the area behind the grille. There are four 16-gauge (1.0 mm²) wires for connecting to the grille lights (GY, TN) and siren speaker (LT BU, LT GN)

WINDSHIELD PILLAR-MOUNTED SPOTLAMP - OPTION 7X6 AND 7X7

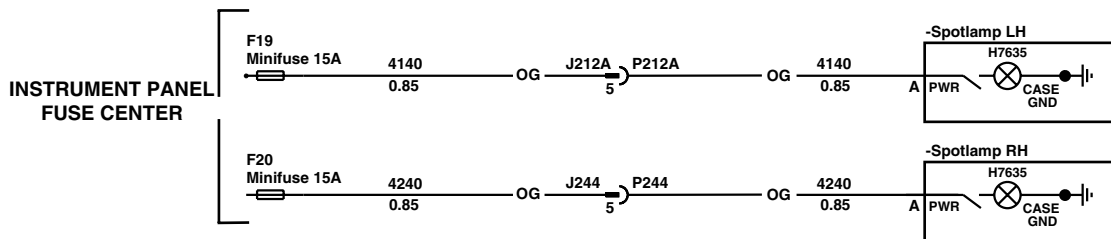

7X6 spotlamp left hand and 7X7, spotlamps left and right hand, pillar-mounted Unity, 6-inch with replaceable H3 halogen bulb; independently fused

Note: Wiring diagrams for these options are shown in the Police Package owner's manual supplement (shipped in glove box).

WIRING PROVISION FOR FRONT SPEAKERS - OPTION WX7

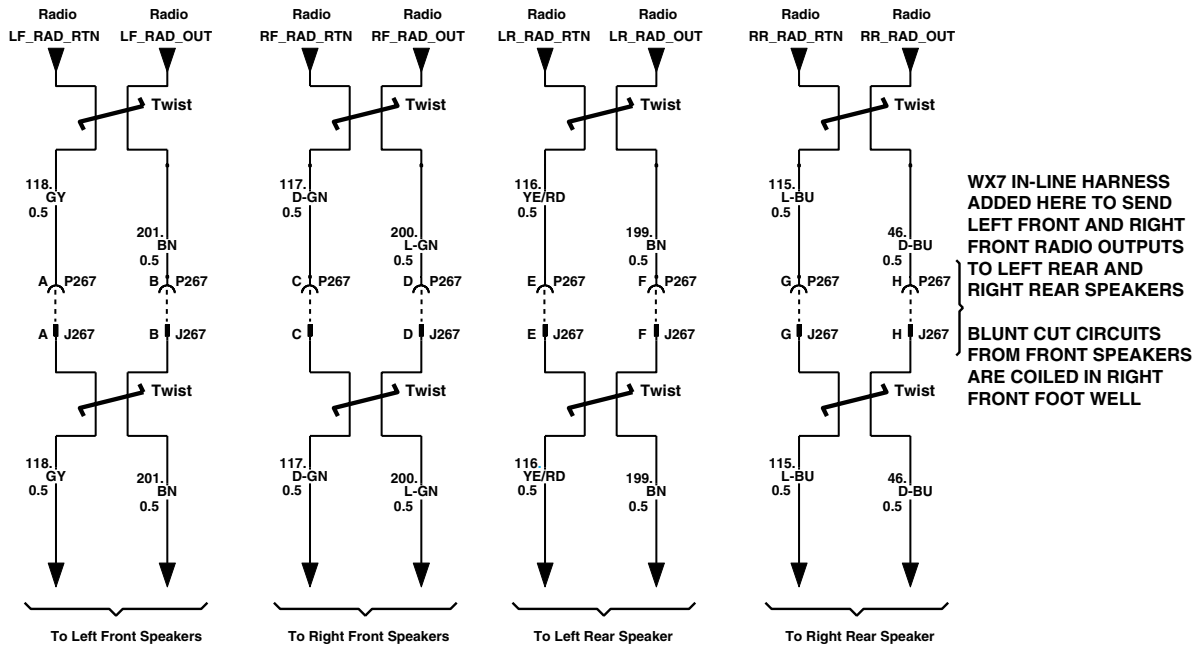

Approximately 60 inches (1.5 m) of auxiliary speaker wiring is routed from the front door and windshield pillar speakers and coiled under the instrument panel. The wiring permits connection of the front speaker pairs to customer-installed communication equipment. Vehicle radio front speaker outputs are re-routed to the rear speakers to maintain the required open door/key-in-ignition audible warning. A vehicle radio mute circuit is available to mute the radio audio signal when customer radio is transmitting. See the wiring diagram for Controlled Power and Signal Circuits

WIRING PROVISION - 25MM ACCESS HOLE - RH DASH PANEL

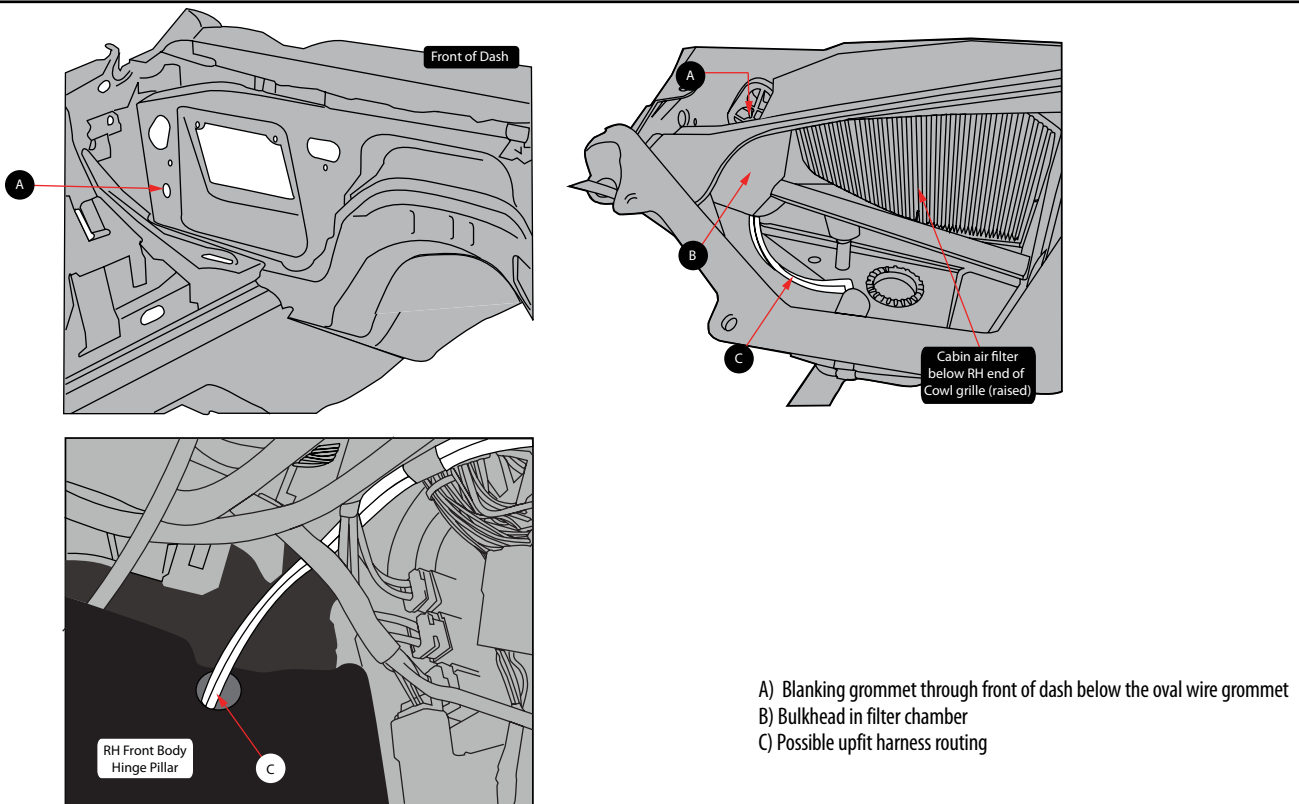

GM offers Anti-Lock Brake Systems as standard or optional on all North American passenger vehicles and light truck lines. The computerized Anti-Lock Braking System (ABS) is designed to keep the vehicle's wheels rotating as the brakes are applied to assist the driver in achieving a controlled stop. Sensors monitor how fast the wheels rotate and feed the data continuously to the ABS computer. The vehicle's brakes slow each wheel as the brake pedal is applied. However, when ABS is activated due to road conditions, the system repeatedly releases and applies pressure to the brakes. The wheels can keep rolling, thus retaining steering ability and enhanced stability while providing a higher braking force on most surfaces than a locked wheel provides.

How exactly does ABS work?

In cars without ABS, hitting the brakes can cause the wheels to lock, leaving you unable to steer the vehicle until you decrease the pressure so the wheels can roll again. With an ABS, as you apply the brakes, the ABS computer monitors the wheel speed sensor information. If the computer senses that a wheel is approaching lock up, it sends a signal to the hydraulic modulator to reduce, then to reapply, brake pressure several times a second for as long as you maintain firm pressure on the brake pedal. The process is much like the threshold braking technique used with conventional brakes. However, ABS does it much faster and more accurately than any driver can, leaving you free to focus on steering away from obstacles.

Does ABS reduce stopping distances?

Yes, in braking situations where the wheels on a non-ABS equipped vehicle would lock up, ABS will generally provide shorter controlled stopping distance. The amount of improvement in stopping distance depends on many factors, including the road surface, severity of braking, initial vehicle speed, etc. On some surfaces, such as gravel roads, braking distances can be longer, but you will still have the control benefits of ABS. The important capability of ABS is control. ABS provides improved vehicle steerability and stability when braking.

What can affect the ABS advantage?

It is important that you follow the maintenance schedule recommended in the owner's manual of the vehicle, tires should be at their proper inflation level, the brake pads should be checked regularly, etc. While driving, you should sit comfortably, so that your hips are back in the seat and your knees are bent, even while braking. Your foot should be positioned so that your heel is on the floor and your toes are secure on the lower half of the pedal. And, though ABS may reduce stopping distance, remember: The faster you go, the longer it takes you to stop. Keeping a safe distance between you and the vehicle in front of you is always necessary, even with ABS.

What happens if ABS becomes inactive?

The ABS electronic control unit has on-board diagnostic capability. If a fault is detected, the vehicle will revert to the base brake system, and the ABS telltale on the dash will be illuminated. Should this happen, the vehicle should be taken to a dealership for repair as soon as possible.

How do I use ABS?

Depress and hold the pedal. DO NOT PUMP THE BRAKES (that prevents the system from working). Just hold the brake pedal down and let the ABS work for you. You may feel the brake pedal vibrate, or you may notice some noise, but this is normal as the system works for you.

Should I drive an ABS equipped vehicle differently than I would drive a vehicle with conventional brakes?

Most of the time, under normal driving circumstances, there is no difference, and you should always drive with the same caution and care. It is important to realize that ABS only makes a difference when it is activated—when you have to brake hard—and that would only be when the computer senses that a wheel is approaching lock up. When ABS activates keep steady pressure on the brake pedal and then let the ABS work for you. Don't pump the brakes or try to find the threshold. Simply hold the brake pedal down and steer if necessary to avoid an obstacle.

Is ABS always active?

ABS is always available, but not always activated. ABS is activated only when the brake pedal is applied and the computer detects an impending wheel lock condition.

Can older cars be retrofitted with ABS?

No! The brake system is one of the most important features on any passenger vehicle. Several products, which tap into the master cylinder and/or brake system performance, are being sold in the aftermarket. Some of these products imply performance similar to new vehicle anti-lock brake systems.

However, contrary to their claims, add-on systems, which deplete fluid from the master cylinder on brake apply may actually increase a vehicle's stopping distance. This may cause the vehicle to fail to comply with Federal brake standards.

Does ABS always activate at the same speed?

No, the system operates when the computer detects wheel lockup, at any speed above 8 mph.

Will ABS wear out a vehicle's brakes sooner?

A properly maintained brake system will be unaffected by ABS operation under typical driving conditions.

Are there different types of ABS?

Yes, there are rear wheel anti-lock systems (RWAL) used on some trucks and four-wheel ABS available on cars and trucks.

Do Federal Safety Standards mandate ABS?

No. Federal standards establish minimum braking performance requirements that all vehicles must meet, but do not specify how they should be met. It should be noted that even a vehicle with failed ABS meets the Federal safety standard for stopping distances.

Will a tire size change affect ABS?

Use of tires other than original equipment may affect ABS performance. Owners should consult and follow the recommendations contained in the vehicle owner's manual regarding replacement tire size. *Note: ABS will work with original equipment spare tire or tire chains. However, performance is reduced.*

Do insurance companies give a discount for ABS?

Yes, many insurance companies give discounts that range from 5% to 10%. In the states of New York and Florida all insurance companies are required to give an ABS discount of 5% on certain coverages such as bodily injury, property damage, collision, and personal injury protection. In other states the discount varies from insurance company to insurance company. When buying auto insurance, always ask your insurance agent if his/her company gives a discount for vehicles equipped with anti-lock brakes.



IMPORTANT DRIVING SAFETY TIPS



- A. Always maintain a safe following distance.** ABS does not allow you to stop on a dime. (Generally a 2-second following distance is considered safe in ideal conditions.) Watch the vehicle in front of you pass a fixed marker (such as a sign). Count seconds—one-thousand-one, one-thousand-two-until your front bumper reaches the marker. If you do not count out two seconds, then you are too close to the vehicle in front of you. Also, if the roads are wet or icy, or visibility is poor, you should increase your following distance.
- B. Always drive carefully—** especially on slippery surfaces. ABS cannot create friction between the tires and the road surface, it can only give the driver the maximum advantage of the existing adhesion. If the vehicle is traveling on a surface with no adhesion, the best ABS in the world cannot provide a shorter stopping distance or good steering.
- C. It is a good idea to practice an ABS activated stop** and get the feel of the brake pedal. However, please make sure it's at a safe time with no obstacles in your path. And you only really need to try it once or twice to know what happens.

ELECTRONIC STABILITY CONTROL SYSTEMS (STABILITRAK)

StabiliTrak systems help drivers maintain control of their vehicles, especially during emergency lane changes or avoidance maneuvers. StabiliTrak uses various sensors, such as steering wheel angle, wheel speed, yaw velocity, etc., to detect any difference between the path requested by the steering wheel position and vehicle's actual path. When appropriate, the system selectively controls brakes, engine power, and even suspension settings to enhance control of the vehicle's direction and help keep it on course. Independent studies conducted by the National Highway Traffic Safety Administration, the Insurance Institute for Highway Safety, and others have found StabiliTrak to be highly effective in reducing vehicle crashes. General Motors offers StabiliTrak systems on many of its passenger car and light truck models.

See your owner's manual for additional information about the operation of StabiliTrak.

Q. How do I use StabiliTrak?

A. StabiliTrak operates independently of the driver. You should continue to drive your StabiliTrak equipped vehicle with caution and care. GM's StabiliTrak system, StabiliTrak, is designed to be as seamless as possible in operation, to be part of the overall vehicle response and to make a good vehicle better

Q. How does StabiliTrak work?

A. StabiliTrak has the ability to apply control forces to the vehicle independent of the driver. StabiliTrak uses sensors to continuously compare the path indicated by the steering wheel position to the vehicle's actual path. If a discrepancy is detected, StabiliTrak selectively controls vehicle brakes and engine torque to create a yaw moment that helps restore the vehicle's actual path to the path indicated by the steering wheel position. StabiliTrak has the ability to help correct both understeer (where the vehicle is not turning as much as the steering wheel position indicates) and oversteer (where the vehicle is turning more than the steering wheel position indicates). The illustration at right shows how selective braking at a particular wheel can create a compensating yaw moment to help restore the vehicle's actual path to the path indicated by the steering wheel position.

Q. Will a tire change affect StabiliTrak?

A. Use of tires other than original equipment may affect StabiliTrak performance. StabiliTrak is designed to make the best use of available traction. The performance characteristics of the original equipment tires are part of the overall system effectiveness. When you replace tires check the recommendations in your Owners Manual. On GM vehicles, the original equipment tires have a "TPC" (Tire Performance Criteria) code on the sidewall. Replacing the tires with the same "TPC" code will help assure proper StabiliTrak performance.

UPDATES FOR 2012



Shown with aftermarket equipment

NEW FEATURES

- (LFX) 3.6L V6 DOHC SIDI engine with Variable Valve Timing (VVT)
- (MXO) 6-speed automatic transmission
- (QWM) P235/55R17, Goodyear blackwall, W-rated tires with improved dry, wet snow traction
- (RSF) 17" steel wheels
- (RUF) 17" full-size steel spare wheel and tire, replaces RPO code (N81)
- (FHS) E85 FlexFuel capable
- (KW7) 170 amp alternator
- (F71) 2.44 axle ratio
- Larger front brakes, retuned suspension and steering
- StabiliTrak, stability control system, includes traction control
- New Grill
- New front fascia with improved brake cooling ducts
- Chrome trunk trim changed to body color

DELETIONS

- (WRH) Jumper harness cooling fans wiring
- (QPP) P225/60R16 Pirelli tires
- (N99) 16" Heavy-duty steel wheels
- (LGD) 3.9L V6 engine
- (KG4) 150 amp alternator
- (37U) Imperial Blue Metallic
- (57U) Cyber Gray Metallic

2 | IMPALA POLICE PACKAGE – 9C1

*This vehicle has been designed for police work up to and including high speed emergency vehicle operations.
GM restricts the sale of police vehicles and they are not to be sold to retail customers.*

SOME STANDARD EQUIPMENT MAY BE REPLACED BY SPECIAL EQUIPMENT WHEN THE POLICE PACKAGE 9C1 IS ORDERED

MODEL AVAILABILITY

1WS19 Front-wheel drive

STANDARD EQUIPMENT SUMMARY

WARRANTY 3 years / 36,000 mile bumper-to-bumper (whichever comes first, see dealer for details)
5 years / 100,000 mile limited powertrain (whichever comes first, see dealer for details)

INTERIOR FEATURES

AIR CONDITIONING Single-zone manual, with air filtration and environmentally friendly refrigerant R134A
CRUISE CONTROL Electronic with set and resume speed
CUP HOLDER Cup holder with storage tray between seats
DOME LAMPS Auxiliary, interior, sustained illumination.
FLOOR COVERING Carpeting front and rear (carpeted mats are available; see option B34 on page 9)
GLASS Tinted windshield, backlight and side glass
GLOVE BOX Does not have locking door and no light
MIRRORS, VISOR Visor, left hand and right hand with covered vanity mirrors
MIRROR, REARVIEW Inside rearview is manual day night with driver and passenger map lamps
RADIO Electronically tuned AM/FM stereo with CD player, seek-scan, digital clock, auto-tone control, theftlock with integrated rear window antenna (radio delete is not available)
RESTRAINT SYSTEM Safety belts, driver and front passenger with pretensioners, dual stage driver and passenger frontal air bags¹, passenger sensing system and frontal air bag¹ ON/OFF indicator, rollover sensor, dual head curtain air bags¹ for front and rear outboard occupants and front seat back mounted thorax-pelvic air bags¹
SEAT, FRONT High density foam cloth bucket seats with seat back security panel, 6-way power driver and passenger seat adjusters (see page 4) and manual reclining seat backs. Driver seat has manual lumbar control. Front seat frames are strengthened for side impact resistance (see page 18)
SEAT, REAR Vinyl bench with high density foam non-folding seat back (see page 4)
SMOKER'S PACKAGE Not available
SPEEDOMETER/CLUSTER 140 mph certified analog speedometer, 5 mph increments with digital trip odometer and warning lamps. Driver Information Center includes 1 mph redundant digital speed display (see message center listing on page 17)
STEALTH MODE See exterior lamps control on page 21 for operation description
STEERING WHEEL Tilt-wheel with column mounted gear shift lever
THEFT DETERRENT SYSTEM Vehicle PASS-Key® III+, content theft deterrent is disabled (to enable content theft deterrent option UA6 must be ordered)
TRUNK MAT Heavy-duty (see page 18)
TRUNK RELEASE Electric (not ignition controlled), button located on instrument panel, left of steering column; manual inside trunk safety release (ignition control release is available; see option A98 on page 9)
WARNING LAMPS Brake, safety belt, air bag¹, anti-lock brake, check engine (see page 17 for additional information)
WARNING TONES Key-in-ignition, driver door open, driver and passenger safety belt not buckled, headlamps on
WINDOW OPERATION Power with driver express down, rear window lockout switch

ELECTRICAL FEATURES

AUXILIARY POWER, FRONT 100-amp ignition and main power supply wiring under lower right side of instrument panel (see wiring provisions for 12-volt battery power supply on page 19 and 27)
AUXILIARY POWER, TRUNK 100-amp auxiliary power outlet in trunk (see page 29)
GROUND STUD Auxiliary, located in trunk (see page 29)
POWER OUTLETS 2 auxiliary power outlets for additional plug-in equipment located on lower center of instrument panel
WIRING DIAGRAMS See pages 27 through 33 for description; also see Impala Police Package owner's manual supplement (located in glove box folder with standard owner's manual)
WIRING PROVISION, EXTERIOR LAMPS FLASHING Forward lamp harness in-line connector for Exterior Lamp Flashing System (see option 6J7 on page 9)

1. Head curtain side air bags are designed to help reduce the risk of head and neck injuries to front and rear seat occupants on the near side of certain side-impact collisions. Always use safety belts and the correct child restraints for your child's age and size, even in vehicles equipped with air bags. Children are safer when properly secured in a rear seat. See your vehicle Owner's Manual and child safety seat instructions for more information.

EXTERIOR FEATURES

BODY PANELS	Two-sided galvanized steel for all exterior body panels (except roof where not needed)
DEFOGGER	Electric, rear window
DOOR LOCKS	Power non-programmable (automatic door locking and unlocking feature is disabled), child safety locks in rear doors, driver door lock cylinder; trunk keylock cylinder (see page 9); lock cylinders no longer available on passenger front door
HEADLAMPS	Dual halogen composite, includes flash-to-pass feature and automatic lamps control with daytime running lamps (to delete automatic control, see option 9G8 on page 18 and exterior lamps control on page 21)
HORNS	Dual note
KEYLESS ENTRY	Includes two transmitters with non-functional panic button; the keyless entry system used on the police Impala includes a stealth mode feature. When the “unlock” or “lock” button is depressed, no exterior lamps or audible sounds are activated; however, the interior OEM dome lamp will illuminate unless option 7Y6 lamps, inoperative dome and courtesy lamps is ordered; during remote start feature, running lamps will remain illuminated (additional transmitters are available; see option AMF on page 9)
KEYS	Two-sided, random code, for ignition, driver door and trunk only; single key locking system to operate entire fleet is available (fleet coded single key is available; see 6E2 and 6E8 option on page 9)
LICENSE PLATE	Mounting hardware located in glove box; front bracket standard in states requiring front license plates; others must order option VK3
MIRRORS, REARVIEW	Body color, electric Left hand and right hand remote (heated mirrors are available; see option DK2 on page 9)
ONSTAR	Not available with Police Package
PAINT	Base coat/clear coat
TRUNK LAMP	Standard
UNDER HOOD LAMP	Not available
WINDSHIELD WIPERS	Intermittent, anti-lift with washer

CHASSIS FEATURES

ALTERNATOR	170 amp with idle boost (transmission in PARK or NEUTRAL) controlled by battery energy level sensing
BATTERY	720 cca with battery rundown protection; automatically shuts off courtesy lamps (reading/map lamps, trunk and glove box lamps) to protect the battery; lamps are automatically turned off after 20 minutes if they are left on and the ignition is in the “OFF” position (does not protect customer installed equipment)
BODY	Heavy-duty reinforced body components
BRAKES	4-wheel anti-lock disc brakes with police calibration and heavy-duty front brake pads
COOLING	Heavy-duty (high capacity) with 225-watt fans and extended life coolant; coolant hoses are EPDM (ethylene-propylene-diene monomer) rubber; silicone hoses are not required (coolant is DEX-COOL good for 5 years/150,000 miles, protects from -34° F to +265° F and against rust and corrosion)
CHASSIS LUBRICATION	Lubed-for-life chassis
ENGINE	3.6L V6 DOHC SIDI engine with Variable Valve Timing (VVT) with FlexFuel ² (gas or E85 ethanol); includes wide open throttle air conditioning cut off (when overhead lamps, spotlamps, radio antennas, sirens, and other emergency equipment are installed, overall performance may be somewhat lower)
EXHAUST SYSTEM	Stainless steel, single with dual outlets
FUEL TANK CAPACITY	17 gallon (64 liters)
OIL COOLERS	Engine, transmission and power steering oil coolers: external air-to-oil (see page 18)
RADIO SUPPRESSION	Extended life - iridium tip spark plugs and wires that are designed to reduce radio frequency noise levels which may affect communications equipment including operating frequencies in the 38-MHz to 58-MHz range. The Impala is designed with unibody construction, and multiple grounding points are provided for the vehicle electrical system. No additional ground straps are added for the Police Package
STABILITRAK	Stability enhancement system. An advanced computer controlled system that assists the driver with directional control of the vehicle in difficult driving conditions. Each time the vehicle is started, the StabiliTrak system is fully on. StabiliTrak can be controlled by a StabiliTrak button on the instrument panel. The condition of the system is displayed by an instrument panel StabiliTrak indicator light and Driver Information Center (DIC) Messages. Push once, Performance Mode is active and Traction Control is off, push and hold five seconds Traction Control and StabiliTrak is off, push again and Traction Control and StabiliTrak are turned back on
STARTER INTERRUPT	Prevents starter from engaging while the engine is running
STEERING	Power, rack and pinion
STRUTS, FRONT	Heavy-duty
SUSPENSION	4-wheel independent, firm ride and handling with increased ride height springs, heavy-duty front and rear stabilizer bars
TIRES	Goodyear P235/55R17 SBR blackwall, “W” rated with compact spare (full-size spare is available; see option RUF on page 9)
TIRE PRESSURE MONITOR	CHECK TIRE PRESSURE will show on driver message center (see page 17 for description)
TRANSMISSION	6-speed automatic, electronically-controlled transmission provides protection against over-revving the engine in low gear and a mechanical low gear blackout is not required; if a driver manually selects low gear and fails to manually upshift to high gear, the powertrain control module automatically protects the drivetrain. It can be manual shifted up and down with a switch
WHEELS	17" heavy-duty steel
WHEEL CENTER CAP	Chrome bolt-on metal

2. E85 is 85% ethanol and 15% gasoline. To see if there is an E85 station near you, go to www.gmaltfuel.com/e85-station-locator.

4 | IMPALA POLICE PACKAGE – 9C1

POWERTRAIN

ENGINE				TRANSMISSION		AXLE	
OPTION CODE	TYPE	DISPLACEMENT LITERS/CU. IN.	FUEL SYSTEM	OPTION CODE	TYPE	OPTION CODE	RATIO
LFX	V6	3.6/217	FlexFuel ² (gas or E85 ethanol)	MXO	6T70 6-speed auto. with OD	F71	2.44

EMISSIONS - MUST BE SPECIFIED

FE9	FEDERAL EMISSIONS. Use for ordering vehicles that will be registered in all states except California, Connecticut, Maine, Maryland, Massachusetts, New Jersey, New Mexico, New York, Oregon, Pennsylvania, Rhode Island, Vermont and Washington State
YF5	CALIFORNIA EMISSIONS. Use for ordering vehicles that will be registered in California.
NE1	CT/ME/MD/MA/NJ/NM/NY/OR/PA/RI/VT/WA EMISSIONS. Use for ordering vehicles that will be registered in Connecticut, Maine, Maryland, Massachusetts, New Jersey, New Mexico, New York, Oregon, Pennsylvania, Rhode Island, Vermont or Washington State
NB8	Required when option code FE9 "FEDERAL EMISSIONS" is ordered for delivery to a dealer located in California, Connecticut, Massachusetts, Maryland, New Jersey, New Mexico, New York, Oregon, Pennsylvania, Rhode Island and Washington State for a purchaser who will be registering the vehicle outside California, Connecticut, Maine, Maryland, Massachusetts, New Jersey, New Mexico, New York, Oregon, Pennsylvania, Rhode Island, Vermont and Washington State.
NC7	Required when option code YF5 "CALIFORNIA EMISSIONS" or option code NE1 "CT/ME/MD/MA/NJ/NM/NY/OR/PA/RI/VT/WA EMISSIONS" is ordered for delivery to a dealer located in any state except California, Connecticut, Maine, Maryland, Massachusetts, New Jersey, New Mexico, New York, Oregon, Pennsylvania, Rhode Island, Vermont and Washington for a purchaser who will be registering the vehicle in one of these states or sold as permitted below under "EPA Policy on the Sale of California Emission Vehicles"
NB9	Required when option code YF5 is ordered for delivery to a dealer located in Connecticut, Maine, Maryland, Massachusetts, New Jersey, New Mexico, New York, Oregon, Pennsylvania, Rhode Island, Vermont and Washington. Required when option code NE1 is ordered for delivery to a dealer located in California.

TIRES - SPEED RATED







MANUFACTURER	QUANTITY	SIZE	SPEED RATING	TYPE
Goodyear	Four	P235/55R17 SBR blackwall	W	All Season BW

Note: • Compact spare is standard (full-size spare is available see option N81 on page 9)
• Due to specific requirements for performance, durability and safety, GM recommends only the original equipment tire for replacement

SEATS AND INTERIOR TRIM

	SEAT OPTIONS	EBONY
STANDARD Front: Cloth buckets (power driver and passenger) Rear: Vinyl bench (non-folding seat back)	AR9	19G
OPTIONAL Front: Cloth buckets (power driver and passenger) Rear: Cloth bench (non-folding seat back)	AR9	19E

AVAILABLE EXTERIOR COLORS

					
Silver Ice Metallic	Imperial Blue Metallic	Black	Summit White	Gold Mist Metallic	Victory Red
Note: For special paint see page 11 through 16					<i>Actual colors may vary</i>

2. E85 is 85% ethanol and 15% gasoline. To see if there is an E85 station near you, go to www.gmaltfuel.com/e85-station-locator.

UPDATES FOR 2012



Shown with aftermarket equipment

NEW FEATURES

- (LFX) 3.6L V6 DOHC SIDI engine with Variable Valve Timing (VVT)
- (MXO) 6-speed automatic transmission
- (QWM) P235/55R17, Goodyear blackwall, W-rated tires with improved dry, wet snow traction
- (RSF) 17" steel wheels
- (RUF) 17" full-size steel spare wheel and tire, replaces RPO code (N81)
- (FHS) E85 FlexFuel capable²
- (KW7) 170 amp alternator
- (F71) 2.44 axle ratio
- Larger front brakes, retuned suspension and steering
- StabiliTrak, stability control system, includes traction control
- New 17" tires with improved dry, wet and snow traction
- New Grill
- New front fascia with improved brake cooling ducts
- Chrome Strip on trunk changed to body color

DELETIONS

- (WRH) Jumper harness cooling fans wiring
- (QPP) P225/60R16 Pirelli tires
- (N99) 16" Heavy-duty steel wheels
- (LGD) 3.9L V6 engine
- (KG4) 150 amps alternator
- (37U) Imperial Blue Metallic
- (57U) Cyber Gray Metallic

2. E85 is 85% ethanol and 15% gasoline. To see if there is an E85 station near you, go to www.gmaltfuel.com/e85-station-locator.

6 | IMPALA UNDERCOVER POLICE PACKAGE – 9C3

This vehicle has been designed for police work up to and including high speed emergency vehicle operations. GM restricts the sale of police vehicles and they are not to be sold to retail customers.

SOME STANDARD EQUIPMENT MAY BE REPLACED BY SPECIAL EQUIPMENT WHEN THE POLICE PACKAGE 9C1 IS ORDERED

MODEL AVAILABILITY

1WS19 Front-wheel drive

STANDARD EQUIPMENT SUMMARY

WARRANTY 3 years / 36,000 mile bumper-to-bumper (whichever comes first, see dealer for details)
5 years / 100,000 mile limited powertrain (whichever comes first, see dealer for details)

INTERIOR FEATURES

AIR CONDITIONING	Single-zone manual, with air filtration and environmentally friendly refrigerant R134A
CRUISE CONTROL	Electronic with set and resume speed
FLOOR COVERING	Carpeting front and rear (carpeted mats are available; see option B34 on page 9)
DOMELAMPS	Auxiliary, interior, sustained illumination
GLASS	Tinted, windshield, backlight and side glass
GLOVE BOX	Does not have locking door and no light
MIRRORS, VISOR	Visor, left hand and right hand with covered vanity mirrors
MIRROR, REARVIEW	Inside rearview is manual day night with driver and passenger map lamps
RADIO	Electronically tuned AM/FM stereo with CD player, seek-scan, digital clock, auto-tone control, theftlock with integrated rear window antenna (radio delete is not available)
RESTRAINT SYSTEM	Safety belts, driver and front passenger with pretensioners, dual stage driver and passenger frontal air bags ¹ , passenger sensing system and frontal air bag ¹ ON/OFF indicator, rollover sensor, dual head curtain air bags ¹ for front and rear outboard occupants and front seat back mounted thorax-pelvic air bags ¹
SEAT, FRONT	40/20/40 splint-bench cloth seat with folding arm rest and cup holder, 6-way power driver seat with recliner and manual lumbar, 6-way power passenger seat with manual reclining seat back and strengthened front seat frames for side impact resistance (see page 18)
SEAT, REAR	Cloth bench with high density foam non-folding seat back (see page 8)
SMOKER'S PACKAGE	Not available
SPEEDOMETER/CLUSTER	140 mph certified analog speedometer, 5 mph increments with digital trip odometer and warning lamps. Driver Information Center includes 1 mph redundant digital speed display (see message center listing on page 17)
STEALTH MODE	See exterior lamps control on page 21 for operation description
STEERING WHEEL	Tilt-wheel with column mounted gear shift lever
THEFT DETERRENT SYSTEM	Vehicle PASS-Key® III+, content theft deterrent is disabled (to enable content theft deterrent option UA6 must be ordered)
TRUNK MAT	Heavy-duty (see page 18)
TRUNK RELEASE	Electric (not ignition controlled), button located on instrument panel, left of steering column; manual inside trunk safety release (ignition control is available; see option A98 on page 9)
WARNING LAMPS	Brake, safety belt, air bag ¹ , anti-lock brake and check engine (see page 17 for additional information)
WARNING TONES	Key-in-ignition, driver door open, driver and passenger safety belt not buckled, headlamps on
WINDOW OPERATION	Power with driver express down, rear window lockout switch

ELECTRICAL FEATURES

AUXILIARY POWER, FRONT	100-amp ignition and main power supply wiring under lower right side of instrument panel (see wiring provisions for 12-volt battery power supply on page 19 and 27)
AUXILIARY POWER, TRUNK	100-amp auxiliary power outlet in trunk (see page 29)
GROUND STUD	Auxiliary, located in trunk (see page 29)
POWER OUTLETS	2 auxiliary power outlets for additional plug-in-equipment located on lower center of instrument panel
WIRING DIAGRAMS	See pages 27 through 33 for description; also see Impala Police Package owner's manual supplement (located in glove box folder with standard owner's manual)
WIRING PROVISION, EXTERIOR LAMPS FLASHING	Forward lamp harness in-line connector for Exterior Lamp Flashing System (see option 6J7 on page 9)

1. Head curtain side air bags are designed to help reduce the risk of head and neck injuries to front and rear seat occupants on the near side of certain side-impact collisions. Always use safety belts and the correct child restraints for your child's age and size, even in vehicles equipped with air bags. Children are safer when properly secured in a rear seat. See your vehicle Owner's Manual and child safety seat instructions for more information.

EXTERIOR FEATURES

BODY PANELS	Two-sided galvanized steel for all exterior body panels (except roof where it is not needed)
DEFOGGER	Electric, rear window
DOOR LOCKS	Power non-programmable (automatic door locking and unlocking feature is disabled), child safety locks in rear doors, driver door lock cylinder; trunk keylock cylinder (see page 18) lock cylinders no longer available on passenger front door
HEADLAMPS	Dual halogen composite, includes flash-to-pass feature and automatic lamp control with daytime running lamps (to delete automatic control, see option 9G8 on page 9 and exterior lamps control on page 21)
HORNS	Dual note
KEYLESS ENTRY	Includes two transmitters with non-functional panic button; the keyless entry system used on the police Impala includes a stealth mode feature. When the “unlock” or “lock” button is depressed, no exterior lamps or audible sounds are activated; however, the interior OEM dome lamp will illuminate unless option 7Y6 lamps, inoperative dome and courtesy lamps is ordered; during remote start feature, running lamps will remain illuminated (additional transmitters are available; see option AMF on page 9)
KEYS	Two-sided, random code, for ignition, driver door and trunk only; single key locking system to operate entire fleet is available (fleet coded single key is available; see option 6E2 and 6E8 on page 9)
LICENSE PLATE	Mounting hardware located in glove box; front bracket standard in states requiring front license plates; others must order option VK3
MIRRORS, REARVIEW	Body color, electric left hand and right hand remote (heater mirrors are available; see option DK2 on page 9)
ONSTAR	Not available with Police Package
PAINT	Base coat/clear coat
TRUNK LAMP	Standard
UNDER HOOD LAMP	Not available
WINDSHIELD WIPERS	Intermittent, anti-lift with washer

CHASSIS FEATURES

ALTERNATOR	170 amp with idle boost (transmission in PARK or NEUTRAL) controlled by battery energy level sensing
BATTERY	720 cca with battery rundown protection; automatically shuts off courtesy lamps (reading/map lamps, trunk and glove box lamps) to protect the battery; lamps are automatically turned off after 20 minutes if they are left on and the ignition is in the “OFF” position (does not protect customer installed equipment)
BODY	Heavy-duty reinforced body components
BRAKES	4-wheel anti-lock disc brakes with police calibration and heavy-duty front brake pads
COOLING	Heavy-duty (high capacity) with 225-watt fans and extended life coolant; coolant hoses are EPDM (ethylene-propylene-diene monomer) rubber; silicone hoses are not required (coolant is DEX-COOL good for 5 years/150,000 miles, protects from -34° F to +265° F and against rust and corrosion)
CHASSIS LUBRICATION	Lubed-for-life chassis
ENGINE	3.6L V6 DOHC SIDI engine with Variable Valve Timing (VVT) with FlexFuel ² (gas or E85 ethanol); includes wide open throttle air conditioning cut off (when overhead lamps, spotlamps, radio antennas, sirens, and other emergency equipment are installed, overall performance may be somewhat lower)
EXHAUST SYSTEM	Stainless steel, single with dual outlets
FUEL TANK CAPACITY	17 gallon (64 liters)
OIL COOLERS	Engine, transmission and power steering oil coolers: external air-to-oil (see page 18)
RADIO SUPPRESSION	Extended life - iridium tip spark plugs and wires that are designed to reduce radio frequency noise levels which may affect communications equipment including operating frequencies in the 38-MHz to 58-MHz range. The Impala is designed with unibody construction, and multiple grounding points are provided for the vehicle electrical system. No additional ground straps are added for the Police Package
STABILITRAK	Stability enhancement system. An advanced computer controlled system that assists the driver with directional control of the vehicle in difficult driving conditions. Each time the vehicle is started, the StabiliTrak system is fully on. StabiliTrak can be controlled by a StabiliTrak button on the instrument panel. The condition of the system is displayed by an instrument panel StabiliTrak indicator light and Driver Information Center (DIC) Messages. Push once, Performance Mode is active and Traction Control is off, push and hold five seconds Traction Control and StabiliTrak is off, push again and Traction Control and StabiliTrak are turned back on
STARTER INTERRUPT	Prevents starter from engaging while the engine is running
STEERING	Power, rack and pinion
STRUTS, FRONT	Heavy-duty
SUSPENSION	4-wheel independent, firm ride and handling with increased ride height springs, heavy-duty front and rear stabilizer bars
TIRES	Goodyear P235/55R17 SBR blackwall, “W” rated with compact spare (full-size spare is available; see option RUF on page 9)
TIRE PRESSURE MONITOR	CHECK TIRE PRESSURE will show on driver message center (see page 17 for description)
TRANSMISSION	6-speed automatic, electronically-controlled transmission provides protection against over-revving the engine in low gear and a mechanical low gear blockout is not required; if a driver manually selects low gear and fails to manually upshift to high gear, the powertrain control module automatically protects the drivetrain. It can be manual shifted up and down with a switch
WHEELS	17" heavy-duty steel
WHEEL COVERS	Full-size plastic wheel covers

2. E85 is 85% ethanol and 15% gasoline. To see if there is an E85 station near you, go to www.gmaltfuel.com/e85-station-locator.

POWERTRAIN

ENGINE				TRANSMISSION		AXLE	
OPTION CODE	TYPE	DISPLACEMENT LITERS/CU. IN.	FUEL SYSTEM	OPTION CODE	TYPE	OPTION CODE	RATIO
LFX	V6	3.6/217	FlexFuel ² (gas or E85 ethanol)	MX0	6T70 6-speed auto. with OD	F71	2.44

EMISSIONS - MUST BE SPECIFIED

FE9	FEDERAL EMISSIONS. Use for ordering vehicles that will be registered in all states except California, Connecticut, Maine, Maryland, Massachusetts, New Jersey, New Mexico, New York, Oregon, Pennsylvania, Rhode Island, Vermont and Washington State
YF5	CALIFORNIA EMISSIONS. Use for ordering vehicles that will be registered in California.
NE1	CT/ME/MD/MA/NJ/NM/NY/OR/PA/RI/VT/WA EMISSIONS. Use for ordering vehicles that will be registered in Connecticut, Maine, Maryland, Massachusetts, New Jersey, New Mexico, New York, Oregon, Pennsylvania, Rhode Island, Vermont or Washington State
NB8	Required when option code FE9 "FEDERAL EMISSIONS" is ordered for delivery to a dealer located in California, Connecticut, Massachusetts, Maryland, New Jersey, New Mexico, New York, Oregon, Pennsylvania, Rhode Island and Washington State for a purchaser who will be registering the vehicle outside California, Connecticut, Maine, Maryland, Massachusetts, New Jersey, New Mexico, New York, Oregon, Pennsylvania, Rhode Island, Vermont and Washington State.
NC7	Required when option code YF5 "CALIFORNIA EMISSIONS" or option code NE1 "CT/ME/MD/MA/NJ/NM/NY/OR/PA/RI/VT/WA EMISSIONS" is ordered for delivery to a dealer located in any state except California, Connecticut, Maine, Maryland, Massachusetts, New Jersey, New Mexico, New York, Oregon, Pennsylvania, Rhode Island, Vermont and Washington for a purchaser who will be registering the vehicle in one of these states or sold as permitted below under "EPA Policy on the Sale of California Emission Vehicles"
NB9	Required when option code YF5 is ordered for delivery to a dealer located in Connecticut, Maine, Maryland, Massachusetts, New Jersey, New Mexico, New York, Oregon, Pennsylvania, Rhode Island, Vermont and Washington. Required when option code NE1 is ordered for delivery to a dealer located in California.

TIRES - SPEED RATED







MANUFACTURER	QUANTITY	SIZE	SPEED RATING	TYPE
Goodyear	Four	P235/55R17 SBR blackwall	W	All Season BW

*Note: - Compact spare is standard (full-size spare is available see option N81 on page 9)
- Due to specific requirements for performance, durability and safety, GM recommends only the original equipment tire for replacement*

SEATS AND INTERIOR TRIM

	SEAT OPTIONS	EBONY
STANDARD Front Cloth 40/20/40 split-bench Rear: Cloth full bench (non-folding seat back)	AN3	19C

AVAILABLE EXTERIOR COLORS

 17U Silver Ice Metallic	 37U Imperial Blue Metallic	 41U Black	 50U Summit White	 51U Gold Mist Metallic	 74U Victory Red
---	--	---	--	--	---

Note: For special paint see page 11 through 16 *Actual colors may vary*

2. E85 is 85% ethanol and 15% gasoline. To see if there is an E85 station near you, go to www.gmaltfuel.com/e85-station-locator.

B86	BODY SIDE MOLDINGS - Body-color (installed on all 4 doors)
UA6	CONTENT THEFT DETERRENT ALARM SYSTEM - Requires AP3 remote start, unauthorized entry sounds horn and lamps flash
9G8	DELETE DAYTIME RUNNING LAMPS AND AUTOMATIC HEADLAMPS
6J7	FLASHER SYSTEM, HEADLAMP AND TAIL LAMP - DRL compatible, headlamp flasher module with control wire and body control module rear lamp flashing
6A3	FLOOR COVERING - Heavy-duty vinyl replaces production carpeting (carpeted mats not available)
6B2	HANDLES - Rear door inoperative (doors can be opened only from outside)
K05	HEATER - Engine block
6B7	HOLE IN ROOF - On center line requires 6F5 wiring (not available with 6J5 hole)
6J5	HOLE IN ROOF - On passenger side requires 6F5 wiring (not available with 6B7 hole)
AMF	KEYLESS ENTRY TRANSMITTERS - Fleet Package includes 6 additional transmitters. Transmitters are not programmed. Each transmitter, including the two standard with the vehicle, must be programmed together by a dealer at customer expense. Transmitter programming is not a warranty item. See you owners manual supplement for programming information. (see also page 22 for customer programming of transmitters using the vehicles Driver Information Center procedure) Note: Vehicle specific, common fleet transmitter frequency not available
6E2	KEY COMMON - Complete vehicle fleet, provides a single key with a specific code that is common to the door locks and ignition of all the vehicles in the vehicle fleet; key code is an alternate to SEO 6E8 key common, complete vehicle fleet; not compatible with 2005 and earlier Impalas, 2006 and earlier Tahoes and 2011 Caprice
6E8	KEY COMMON - Complete vehicle fleet, provides a single key with a specific code that is common to the door locks and ignition of all the vehicles in the vehicle fleet; key code is an alternate to SEO 6E2 key common, complete vehicle fleet; not compatible with 2005 and earlier Impalas and 2006 and earlier Tahoes and 2011 Caprice
6C7	LAMP - Front auxiliary dome
7Y6	LAMP - Inoperative dome and courtesy lamps
6J6	LAMPS - Rear window auxiliary stop/turn signals
T53	LAMPS - Alternate flashing trunk lid warning
VK3	LICENSE PLATE BRACKET - Front (bracket standard for states requiring front license plate)
6N6	LOCKS - Rear door inoperative
B34	MATS - Carpeted front and rear (not available with 6A3)
DK2	MIRRORS - Heated outside rearview, power, body color
D81	REAR SPOILER
6N5	REAR WINDOW SWITCHES INOPERATIVE - Rear windows only operate from driver's position
AP3	REMOTE VEHICLE STARTER SYSTEM - Includes remote keyless entry
7X6	SPOTLAMP - Left hand, separately fused
7X7	SPOTLAMPS - Left and right hand, separately fused
7X8	SPOTLAMP PROVISION - Left hand
7X9	SPOTLAMP PROVISION - Left and right hand
RUF	TIRE, SPARE - Full-size (includes non-programed Tire Pressure Monitor)
A98	TRUNK RELEASE - Ignition controlled
6C8	WIRING - Coaxial radio antenna cable - RG58 roof to trunk
VX7	WIRING - For customer connection to front door and windshield pillar speakers. Speakers are not connected to the vehicle radio; radio audio signals are routed to the rear speakers
6J3	WIRING - For grille lamps and speaker
6J4	WIRING - For horn/siren circuit, in-line connection for customer furnished switch
6F5	WIRING - Roof wires (requires 6B7 or 6J5 hole in roof, 2 number 10 AWG wires only)

For standard and optional illustrations, see pages 18 through 22.

Note: Ship-through charge is included as part of base MSRP.

10 | IMPALA 9C1 AND 9C3 POLICE PACKAGE SPECIFICATIONS

GENERAL

Model	1WS19
Drive	2-wheel front

EXTERIOR (in./mm)

Wheelbase	110.5/2807
Overall length	200.4/5090
Overall width	72.9/1852
Overall height	58.7/1491
Front track width	62.4/1585
Rear track width	61.5/1562
Turning diameter curb to curb (ft./m)	38.0/11.6
Ground clearance (engine cradle)	7.1/180

FRONT COMPARTMENT (in./mm)

Head room	39.4/1001
Shoulder room	58.7/1491
Hip room	56.4/1433
Leg room (maximum)	42.3/1074

REAR COMPARTMENT (in./mm)

Head room	37.8/960
Shoulder room	58.6/1488
Hip room	57.2/1453
Leg room (minimum)	37.6/955

LUGGAGE COMPARTMENT CAPACITY (cu. ft./liters)

Luggage capacity ³ (with space saver)	18.6/526
EPA passenger compartment volume index ³	104.8/2968

FUEL ECONOMY RATINGS CITY/HIGHWAY/COMBINED

3.6L engine ⁴	17/28/21
--------------------------	----------

EPA label values, actual mileage will vary with options, driving conditions, driving habits and vehicle condition.

ALTERNATOR

Type	SC3
Amps	77°F (25°C) 170

KW7 IMPALA POLICE ALTERNATOR OUTPUT

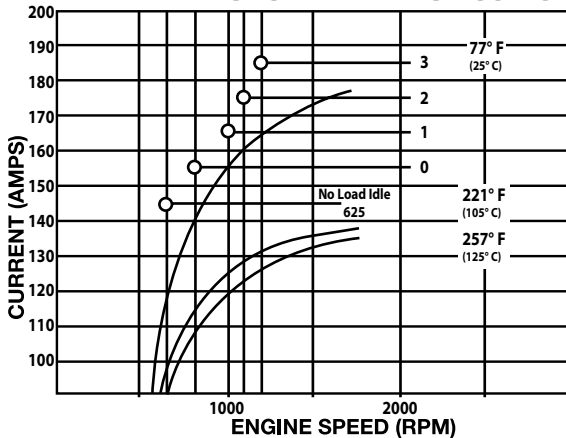

Boost Level	Park/Neutral	Drive
0	800	800
1	1000	800
2	1100	800
3	1200	800

3. Cargo and load capacity limited by weight and distribution.

4. EPA-estimated MPG.

5. Gross Vehicle Weight Rating (GVWR). When properly equipped, includes vehicle, passengers, cargo and equipment.

6. Maximum payload capacity includes weight of driver, passengers, optional equipment and cargo.

ENGINE

Type	V6
Displacement: liters/cu. in.	3.6/217
Horsepower/rpm	302/6800
Torque lb.-ft./rpm	262/5300
Induction system	SIDI
Compression ratio	11.5:1
Exhaust	Single with dual outlets
Minimum recommended fuel octane	87
Fuel tank capacity (gallons/liters)	17/64.0
Oil with filter (quarts/liters)	4.0/3.8
Cooling capacity (quarts/liters)	10.6/10.0

TRANSMISSION

Automatic, electronically-controlled with overdrive	6-speed
Fluid pan removed & filter replaced (quarts/liters)	7.4/7.0

AXLE

Ratio	2.44
-------	------

BRAKES

ABS with vacuum boost	Disc/Disc
Front - swept area (sq. in./sq. cm)	246.3/1589.6
Rear - swept area (sq. in./sq. cm)	175.8/1134
Total front and rear swept area (sq. in./sq. cm)	422.1/65.5
Front rotor diameter (in./mm)	12.7/323
Rear rotor diameter (in./mm)	10.9/277
Front rotor thickness (in./mm)	1.2/30
Rear rotor thickness (in./mm)	.5/14

TIRES

Type	All Season W-speed rated
Size	P235/55R17

WHEELS

Type	Steel
Size	17"

CHASSIS

Frame	Unitized body
Engine cradle	Aluminum
Front suspension	Independent MacPherson Strut, coil spring over strut and stabilizer bar
Rear suspension	Independent Tri-Link MacPherson Strut, coil spring over strut and stabilizer bar
Steering type	Power rack and pinion
Steering ratio (center)	14.1:1

BATTERY

Type	Maintenance free
BCI group size	34
Volts	12
Amp hour rating	70
Cold cranking amps @ 0°F (-18°C)	720
Reserve capacity @ 80°F (27°C)	125

VEHICLE WEIGHT (lbs./kg.)

GVWR ⁵	4938/2240
Base curb (vehicle without original manufactures optional equipment)	3743/1698
Payload ⁶ (includes 5 passengers and space saver spare tire)	944/428

Note: See your vehicle tire and loading information label for specific weight values. See your owners manual supplement for proper cargo loading distribution

To accommodate customers who require special painted vehicles, orders will be sent to Kerr Industries who will special paint the cars once they are built. Please note: **this ordering process is substantially different from the way special paint is ordered on other vehicle lines and requires an additional charge. See your local dealer for current pricing.**

It is recommended that the customer review the first vehicle painted when special paint is ordered, however it is not mandatory. If the customer chooses not to review a pilot vehicle, Kerr Industries will require sign off by the customer before the vehicle will be released.

Customer and dealer costs associated with accommodations and travel for in person review of special paint are the responsibility of the dealer.

TO ORDER SPECIAL PAINT

- RPO White 50U or RPO Black 41U must be ordered
- The 4-digit special paint code in paint code 1/paint code 2 fields will be replaced by options denoting code 1 and code 2 colors
- Paint scheme codes will be replaced by options
- Solid color option is AAS
- 2-tone color option is AAT
- When special paint schemes are ordered only class A surfaces will be painted; mirrors and handles are NOT painted. For additional costs to have the handles and mirrors painted please contact Kerr Industries at 905-725-6561.
- It is recommended that all vehicles be ordered in Black 41U before special paint is applied.
- For paint colors not listed in this brochure please contact Kerr Industries directly at 905-725-6561

Example for Ordering Special Paint:

If a dealer wants a Silver and Blue car with scheme W002, order 50U or 41U (White or Black RPO paint), options BEP (code 1 Blue), BFR (code 2 Silver), 1PB (paint scheme W002) and AAT (2-tone paint)

SPECIAL PAINT WARRANTY

- Warranty claims for special paints must be directed to Kerr Industries at 905-725-6561

AFTER YOU HAVE ORDERED SPECIAL PAINT

- After the vehicles have been ordered for special paint, Kerr Industries will contact the dealer directly regarding colors and verification of the scheme. Once verified a special paint build sheet will be sent to the dealer for final confirmation. This sheet will need to be signed by the dealer and returned to Kerr Industries before painting will commence.

*Note: The attached list of paint options contain the same WA numbers in the code 1 and code 2 columns.
It is extremely important that the dealer order the correct code 1 and code 2 options so the upfitter knows how to paint the vehicles.*

Note: For paint colors not listed please contact Kerr Industries directly at 905-725-6561

12 | SPECIAL PAINT AVAILABLE WITH 9C1 AND 9C3 PACKAGE

WA#	COLOR DESCRIPTION	OPTIONS	
		CODE 1	CODE 2
121A	Adriatic Blue	BEA	BFE
311B	Olive	BEB	BFF
5120	Blue	BEQ	BFU
5236	Neutral	BEC	BFG
5322	Driftwood	BER	BFV
5665	Blue	BED	BFH
5749	Gold	BES	BFW
5845	Beige	BEE	BFI
7153	Blue	BET	BFX
7159	Blue	BEF	BFJ
7262	Brown	BEU	BFY
7801	Brown	BEG	BFK
7840	Silver	BEV	BFZ
7868	Blue	BEH	BFL
7888	Blue	BEW	BGA
7889	Blue	BEP	BFT
7964	Green	BEI	BFM
7999	Blue	BEX	BGB
8380	Blue	BEJ	BFN
8381	Gray	BEY	BGC
8401	Yellow	BEK	BFO
8412	Green	BEZ	BGD
8431	Rose Metallic	BEL	BFP
8554	White	BFA	BGE
8555	Black (41U)	BEM	BFQ
8624	Summit White (50U)	BGB	BGK
8743	Blue Black	BFB	BGF
9021	Silver	BEN	BFR
9382	Blue	BFC	BGG
9403	Tan	BEO	BFS

ACTUAL COLOR MAY VARY

SEO COLOR SCHEME #W001
OPTION CODE 1PA

PAINT
LEGEND:

CODE 1
CODE 2

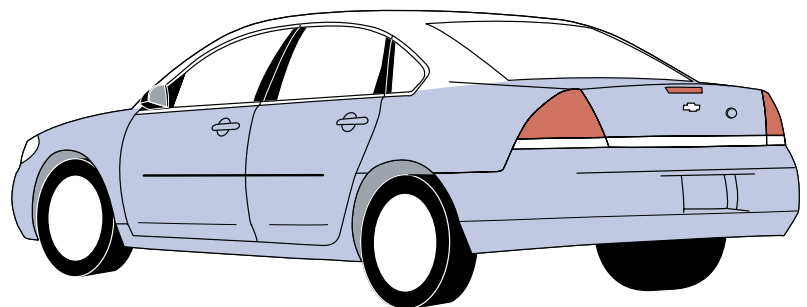
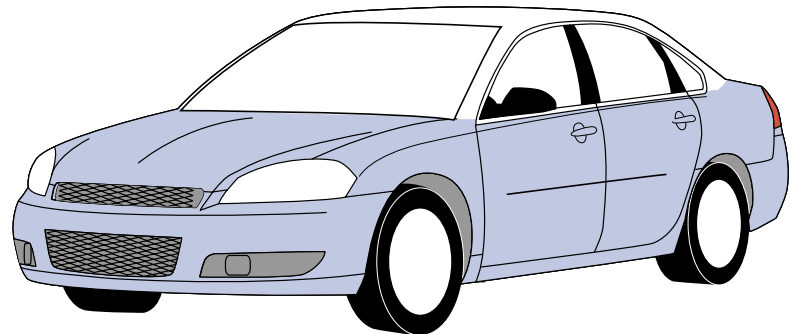
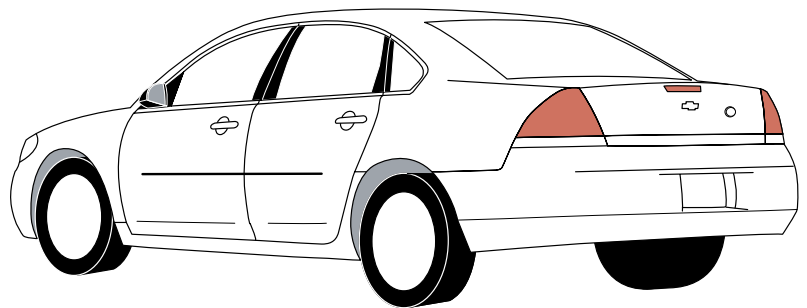
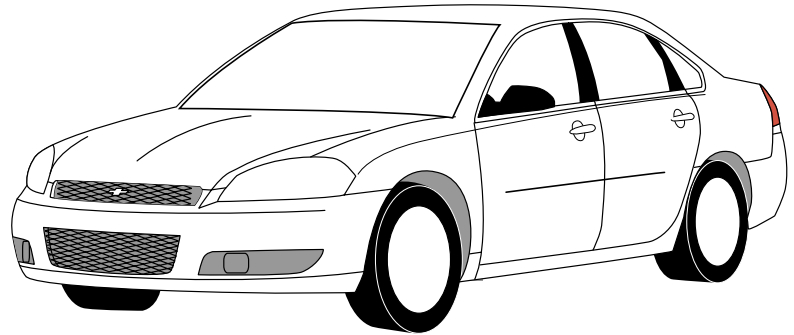

PAINT
LEGEND:

CODE 1
CODE 2

SEO COLOR SCHEME #W002
OPTION CODE 1PB

14 | IMPALA 9C1 AND 9C3 PAINT SCHEMES

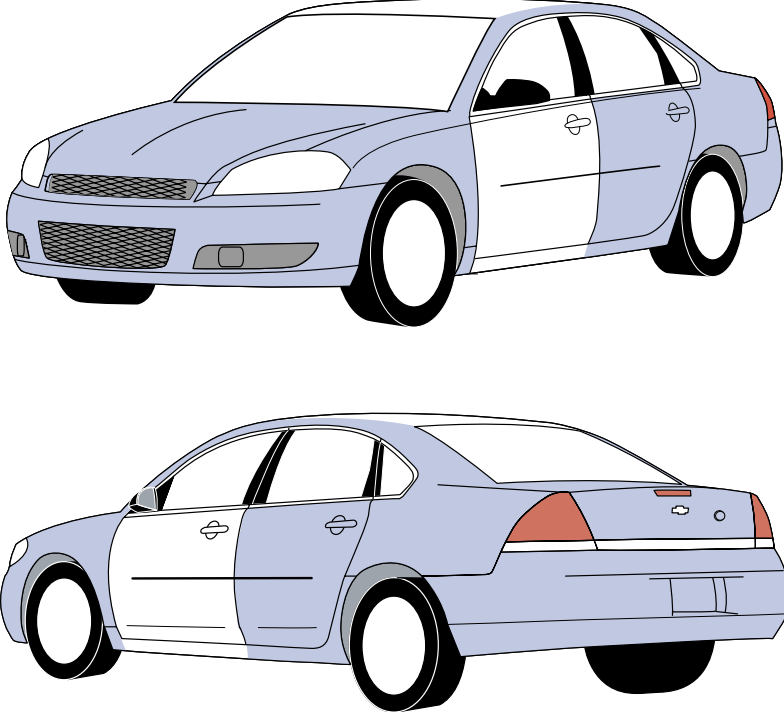

SEO COLOR SCHEME #W003
OPTION CODE 1PC

PAINT LEGEND:

CODE 1 

CODE 2 

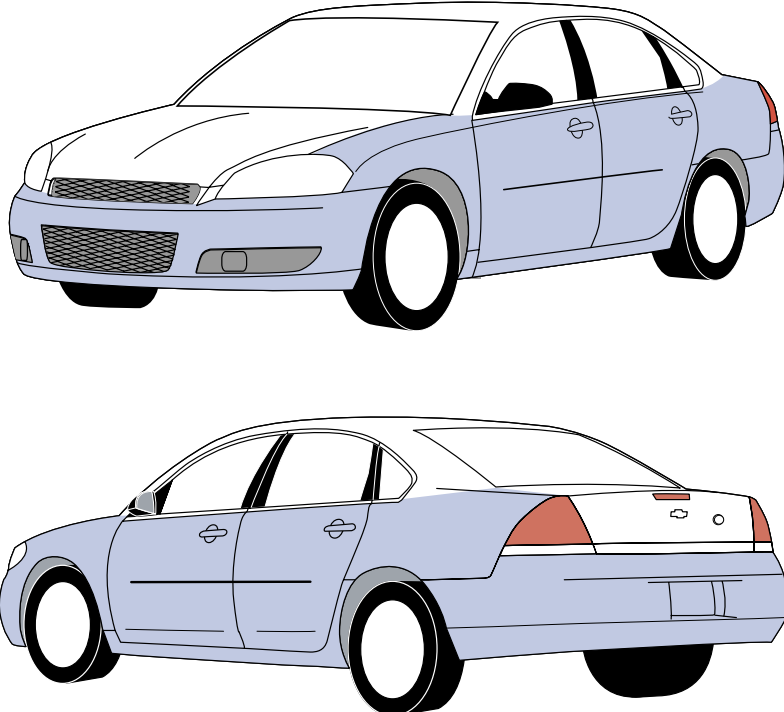

PAINT LEGEND:

CODE 1 

CODE 2 

SEO COLOR SCHEME #W006
OPTION CODE 1PF

SEO COLOR SCHEME #W008
OPTION CODE 1PH

PAINT
LEGEND:

CODE 1 
CODE 2 

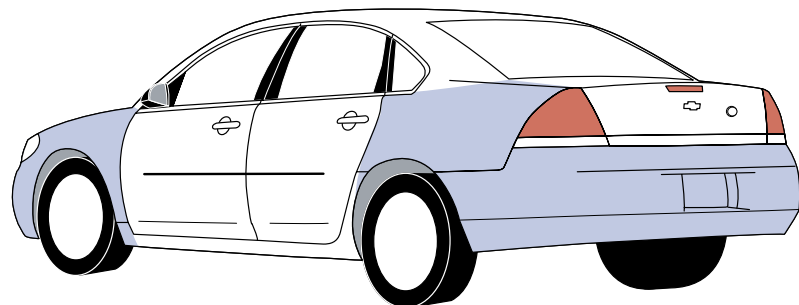
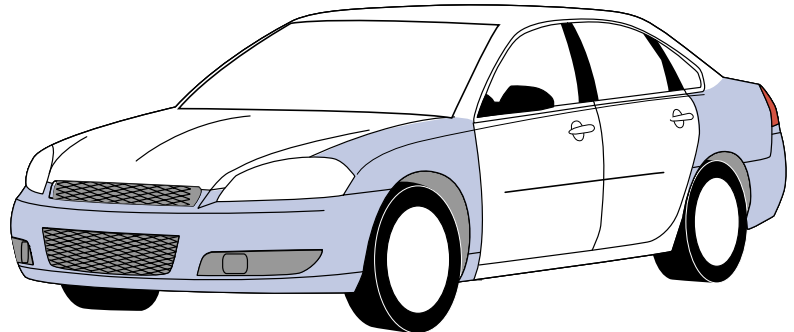
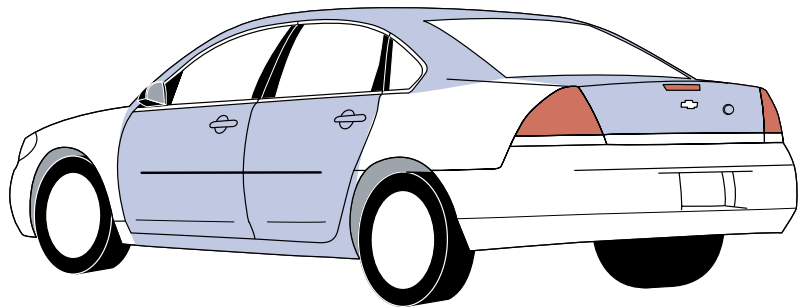
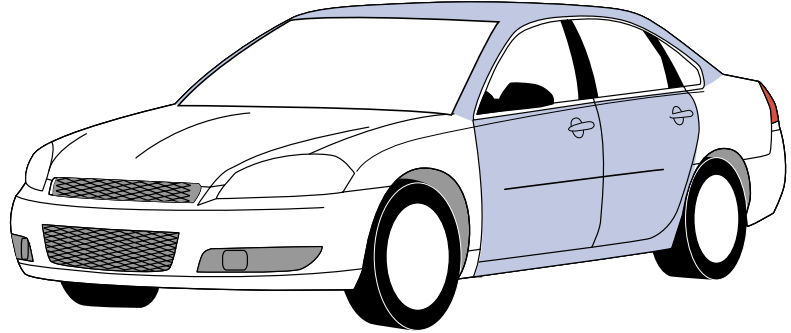

PAINT
LEGEND:

CODE 1 
CODE 2 

SEO COLOR SCHEME #W009
OPTION CODE 1PI

16 | IMPALA 9C1 AND 9C3 PAINT SCHEMES

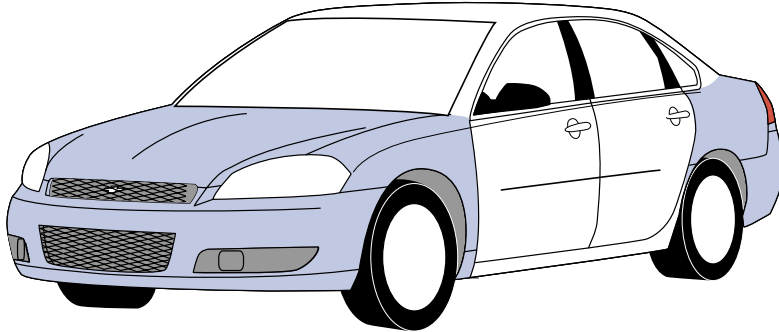

SEO COLOR SCHEME #W012
OPTION CODE 1PL

PAINT
LEGEND:

CODE 1

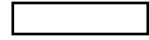

CODE 2

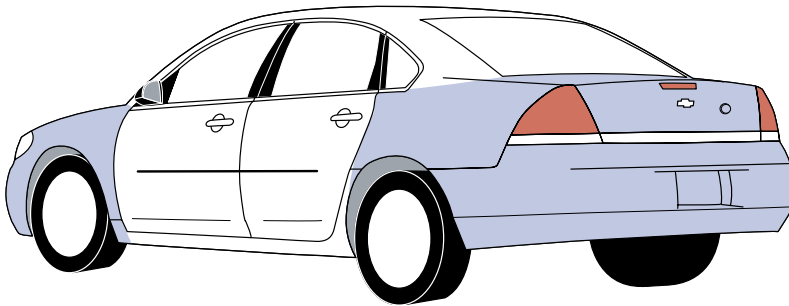

UNITED STATES CERTIFIED SPEEDOMETER/CLUSTER (CANADIAN SIMILAR)

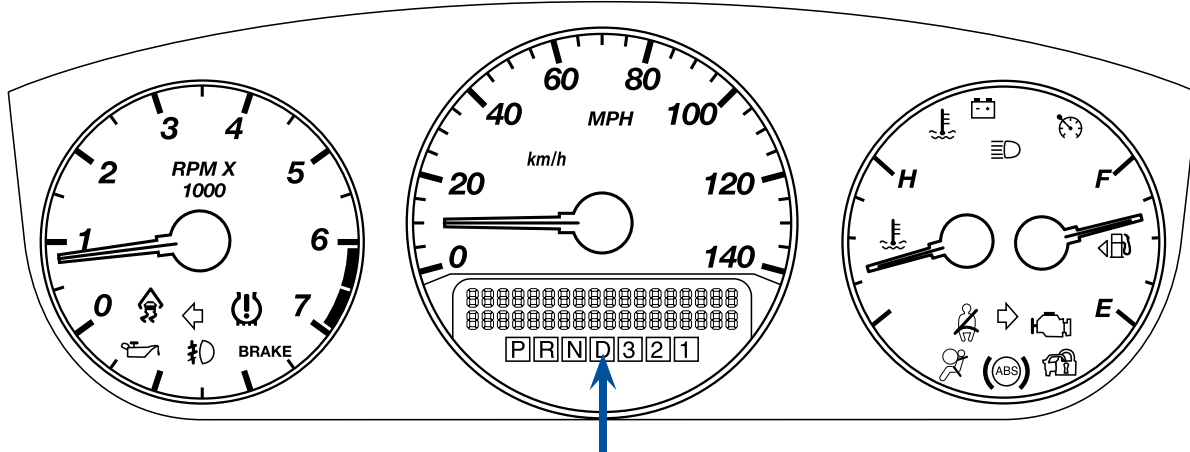

DRIVER INFORMATION MESSAGE CENTER

AUTOMATIC LAMP CONTROL ON [†]	SERVICE BATTERY CHARGING SYSTEM	
AUTOMATIC LAMP CONTROL OFF [†]	SERVICE BRAKE SYSTEM	
BATTERY SAVER ACTIVE	SERVICE POWER STEERING	
CERTIFIED SPEEDOMETER ^{††}	SERVICE THEFT SYSTEM	
CHANGE ENGINE OIL SOON	SERVICE TIRE MONITOR SYSTEM	
CHECK TIRE PRESSURE	SERVICE TRANSMISSION	
DIGITAL MPH READOUT ^{†††}	SERVICE VEHICLE SOON	
DRIVER DOOR OPEN	STARTING DISABLED SERVICE THROTTLE	
ENGINE HOT TURN A/C OFF	THEFT ATTEMPTED [†]	
ENGINE OVERHEATED IDLE ENGINE	TIGHTEN GAS CAP	
ENGINE OVERHEATED STOP ENGINE	TIRE LEARNING ACTIVE	
ENGINE POWER IS REDUCED	TRANSMISSION HOT IDLE ENGINE	
FUEL LEVEL LOW	TRUNK OPEN	
HOOD OPEN	TURN SIGNAL ON	
LEFT REAR DOOR OPEN	WASHER FLUID LOW ADD FLUID	
OIL PRESSURE LOW STOP ENGINE	SPEEDOMETER CERTIFICATION	
PASSENGER DOOR OPEN	2012 Impala police cars certified speedometer calibration. Specifications, at ambient temperature of -10 to 120 degrees F. Inaccuracies due to vehicle speed sensing are included.	
REMOTE KEY LEARNING ACTIVE	ACTUAL VEHICLE SPEED	INDICATED SPEED
REPLACE BATTERY IN REMOTE KEY	0 TO 120 MPH	+/- 2 MPH
RIGHT REAR DOOR OPEN	<i>The speedometer calibration is for the 3.6L engine, automatic transmission with a 2.44 axle and P235/55R17 tires W-rated tires</i>	
SERVICE A/C SYSTEM		
SERVICE AIR BAG		

[†] Message may not be displayed in Police Package

^{††} Message flashes at engine start

^{†††} Can be set as default condition

COOLING SYSTEM

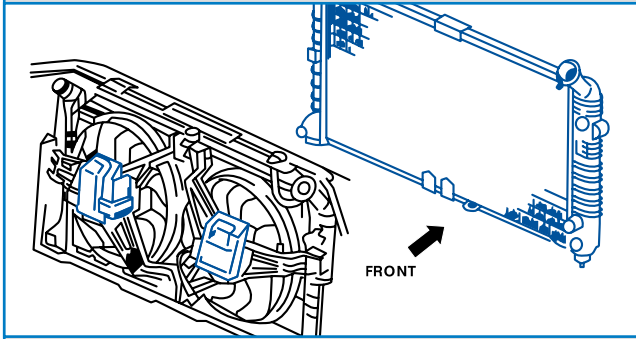

High capacity radiator with 225-watt fans

ENGINE, TRANSMISSION AND POWER STEERING COOLERS

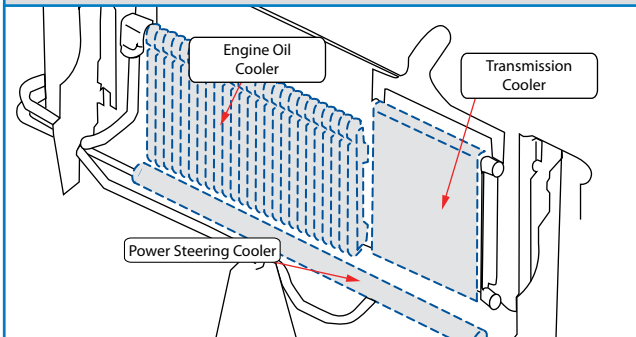

Three auxiliary air-to-oil coolers are mounted in front of the engine coolant radiator. The transmission cooler is connected in series with the coolant radiator end-tank cooler.

KEYLOCK CYLINDER – TRUNK LID

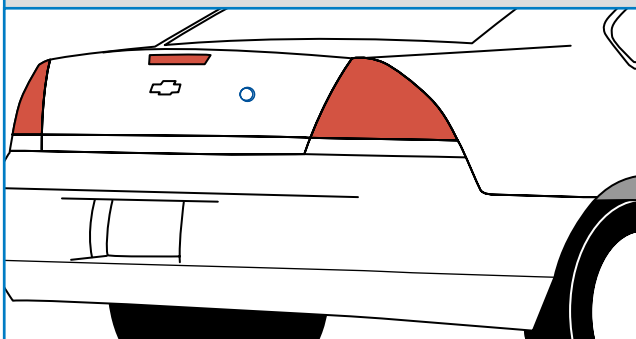

If your vehicle is equipped with the Theft Deterrent System (option UA6), an audible alarm will occur when the key is used to open the trunk instead of the remote keyless entry (key FOB). See your dealer/retailer to disable the audible alarm.

MAT – TRUNK

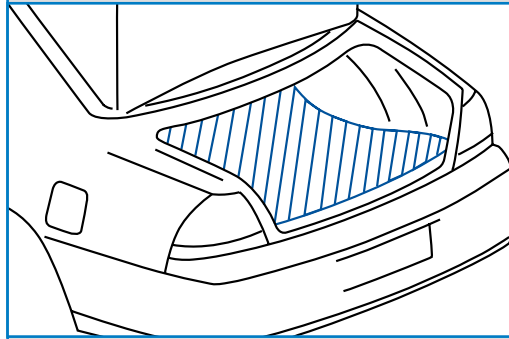

Heavy-duty mat covers floor.

STRENGTHENED FRONT SEAT

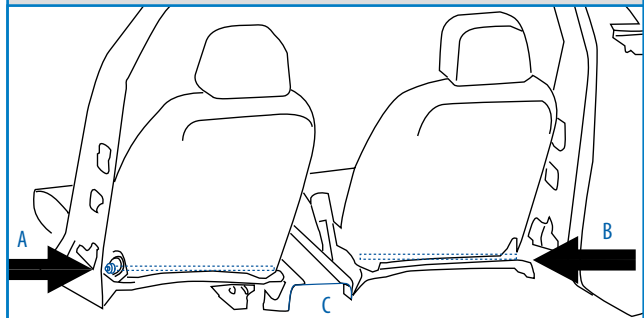

Seat bottom frame structural tubes - A, B
Center floor tunnel-mounted crush box - C

Note: Do not remove the crush box for aftermarket equipment installation

TIRE PRESSURE MONITOR

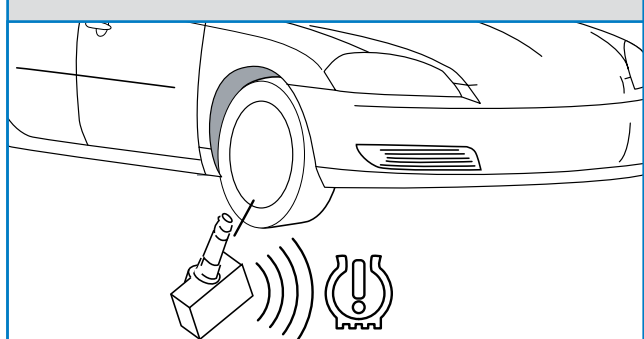

Your vehicle is equipped with a Tire Pressure Monitor (TPM) System which warns of low tire pressure. Your Impala Police Package may be equipped with a full-size spare tire (see page 21) The full-size spare tire has a sensor but is not programmed to read the spare tire pressure. When the full-size spare tire from your vehicle or spare tire from another Police Package is placed in use as a road wheel, the system will not read the presence of the new TPM sensor and must be calibrated. Refer to your owner's manual for additional information on the Tire Pressure Monitor and Sensor Programming. The space saver spare tire does not have a tire pressure monitor.

WIRING PROVISIONS FOR 12-VOLT BATTERY POWER SUPPLY

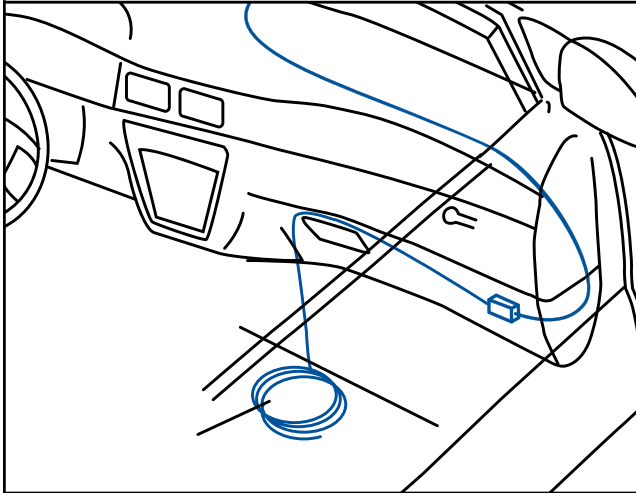

Battery power is supplied through two fusible links, one 50-amp and one 65-amp, to three circuit breakers and two control relays located in the control center above the accelerator pedal. A 50-amp circuit breaker feeds power directly from the 50-amp fusible link through a 10-gauge blunt cut wire. Two 30-amp circuit breakers supply power from the 65-amp fusible link through the contacts of the control relays to 12-gauge blunt cut wires. The blunt cut leads are part of a 5-foot coil on the floor under the instrument panel. Each relay is to be operated by an 18-gauge control lead included in the 5-foot coil under the instrument panel. An 8-gauge system ground lead is also provided in the 5-foot coil. The total current available through the 12-volt power supply is 110-amps.

Two blunt cut wires provide ignition controlled power; one is HOT when the ignition is in ACCESSORY/ON; the second is HOT when the ignition is in START/ON.

A third blunt cut wire from the body control module provides a park-enable signal. When the transmission is in PARK, zero volts (not ground) are present and 12-volts are present when the transmission is in any other position. The circuit is designed to operate a single customer-furnished relay.

A fourth blunt cut wire provides the Vehicle Speed Signal (VSS).

SERVICE PARTS IDENTIFICATION LABEL

SERVICE PARTS IDENTIFICATION										DO NOT REMOVE		
2G1WD5EM3B1142351										PDBJCH 1SW19		
AGK	AG2	AL0	AMF	AP3	AR9	AT8	AXJ	AY0	A75	A76		
BDR	B3B	B42	B86	B9V	C67	DK2	EF7	E2C	FE9	FR9		
IPG	JA9	JL9	KD1	KG4	LGD	MX0	M15	NK5	NT7	N99		
OST	QPP	R7V	R9N	R9Z	SLM	T53	UH8	UJM	UN9	UT7		
UW6	UIC	U77	VT7	V8D	WL9	ZFH	1SZ	19C	50U	191		
3FL	6A3	6E2	6HP	6J1	6J3	6J4	6J7	7B3	7HP	7M9		
7X6	8MZ	9C1	9MZ									
BC/CC		U	636R									

A Service Parts Identification (SPID) Label provides Vehicle Identification Number (VIN)-specific Option Code content list, Engineering Model Number (Nameplate, body style), Exterior paint system, Exterior paint color code and Interior trim level and color. The SPID label for the Impala is located on the right side rear compartment floor. The rear compartment trim must be lifted to access the label.

6A3 COVERING – FLOOR

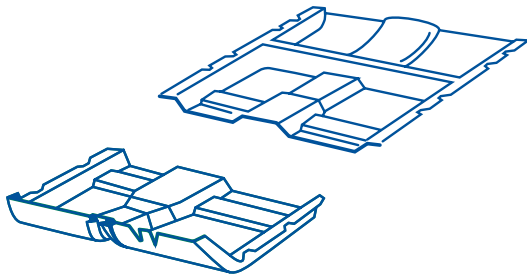

Black heavy-duty front and rear. Replaces production carpeting.

6B2 HANDLES – REAR DOOR INOPERATIVE

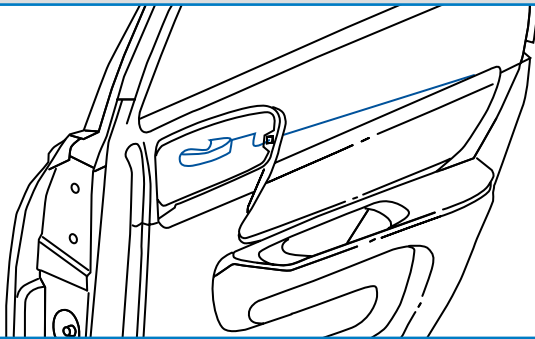

Inside rear door handles are disconnected. Rear doors can only be opened from the outside.

T53 LAMPS – TRUNK LID WARNING

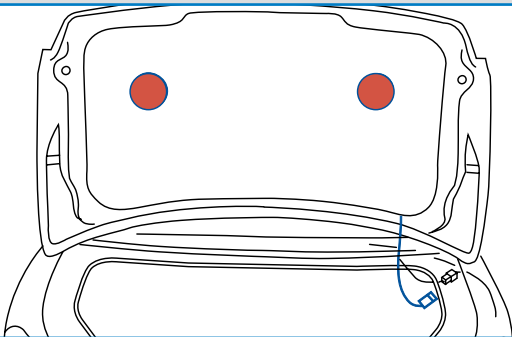

Two 4-inch, red, single-faced lamps are mounted to the deck lid inner panel. Lamps are activated by the deck lid ajar mechanical switch when deck lid is opened. Lamps are wired to flash alternately through a flasher located at the upper right hand corner of the trunk opening.

Wiring is protected by fuse HTDSEAT in the engine compartment fuse block

6N6 LOCKS – REAR DOOR INOPERATIVE

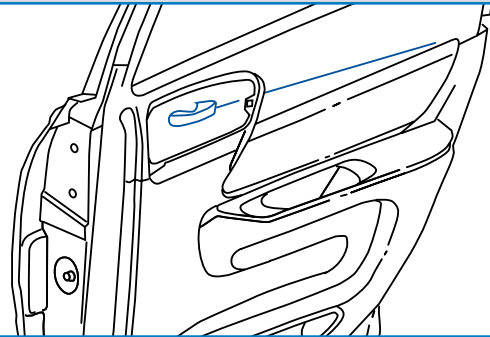

Rear door locking rods are disabled. Rear door locks are inoperable at rear doors, but operate from driver position. Remote rod is shipped in the glove box for future installation.

6N5 SWITCHES – REAR WINDOW INOPERATIVE

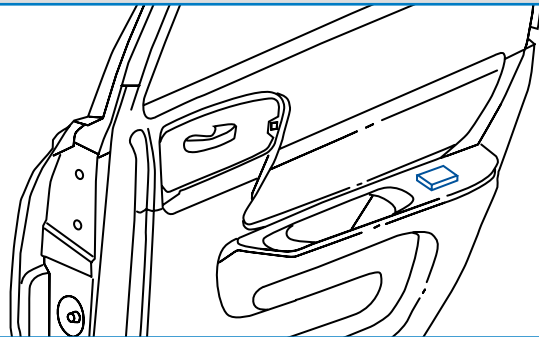

Rear door window switches are inoperable. Rear door power regulators are operable only from driver position switches.

6J6 LAMPS – REAR WINDOW

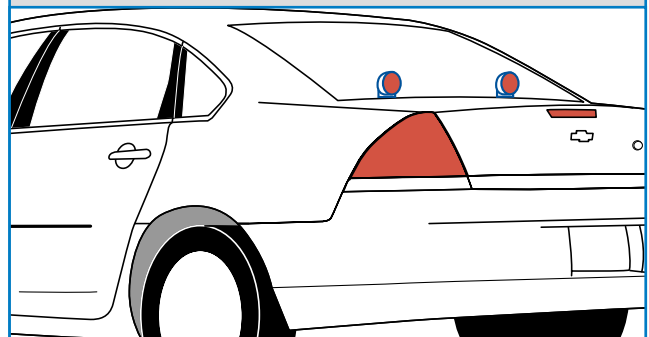

Two 4-inch, red, single-faced lamps are mounted behind rear seatback to be viewed through rear window. The turn signal circuits extend in loops coiled in the right front foot well for customer connection to control switching. These lamps function as auxiliary turn signal, stop lamps and vehicle hazard flashers.

6C8 WIRING – COAXIAL RADIO ANTENNA CABLE

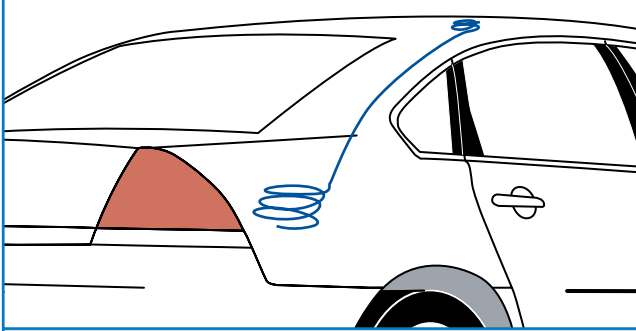

RG58 Coaxial radio antenna cable routed from just rearward of the dome lamp location to trunk. Approximately 24 inches of extra cable is coiled between headliner and roof panel. A coil of sufficient length to reach either corner of the trunk is secured to the right inner wheelhouse. There is no hole in the roof panel.

RUF FULL-SIZE SPARE

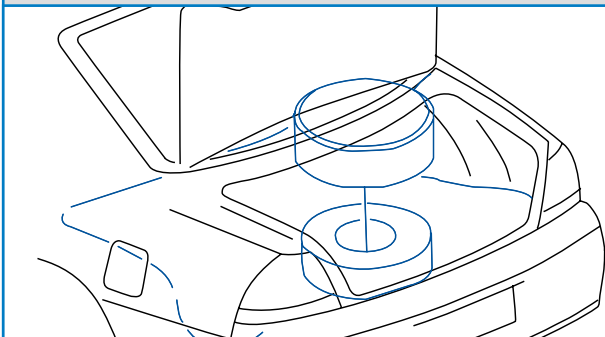

Cover is provided for spare tire and wheel. Full-size spare tire is mounted on top of the standard trunk trim covering the space saver spare tire tub. If full-size spare tire is removed, tub is exposed. The full-size spare tire includes a Tire Pressure Monitor (TPM) sensor which must be programmed to the TPM System after the spare tire is installed. (See page 18)

6C7 LAMP – AUXILIARY DOME

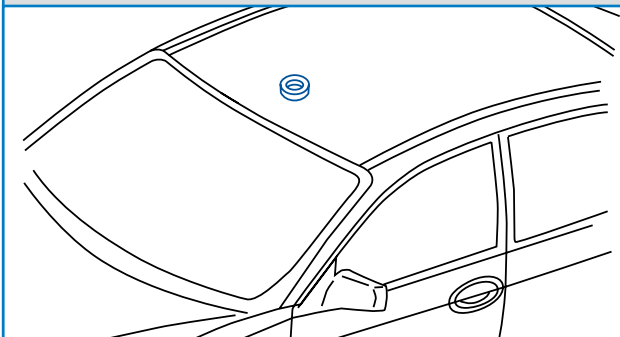

Auxiliary dome lamp located between visors with switch at base of lamp. Wired independently from standard dome lamp.

7Y6 LAMP – INOPERATIVE DOME

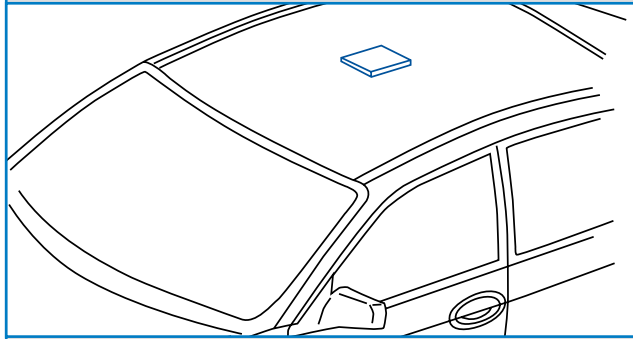

Dome and courtesy lamp will not operate when doors are opened. Dome lamp is controlled only by the instrument light dimmer on the instrument panel.

EXTERIOR LAMPS CONTROL

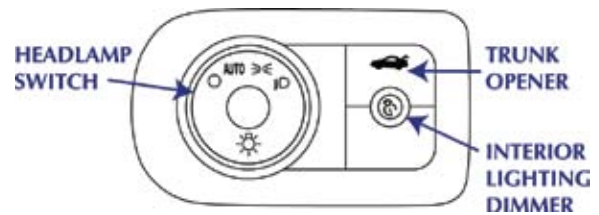

9G8 - Delete Daytime Running Lamps and Automatic Headlamps. This option disables the Daytime Running Lamps and Automatic Headlamps control feature. Exterior lamps are manually controlled only. Option 9G8 is not available in Canada. The headlamp control on the driver's side of the instrument panel operates the headlamps.

If your Impala does not have option 9G8, Daytime Running Lamps and Automatic Headlamps delete, the Daytime Running Lamps and Automatic Headlamps can be turned off for one ignition cycle by rotating the control knob momentarily counter-clockwise. Rotating the headlamp switch again will turn the Daytime Running Lamps and Automatic Headlamps back on.

In Canada, the Daytime Running Lamps and Automatic Headlamps can be turned off if the transmission is in Park. See also section 1 of your Impala owner's manual.

SPOTLAMPS AND SPOTLAMP PROVISIONS

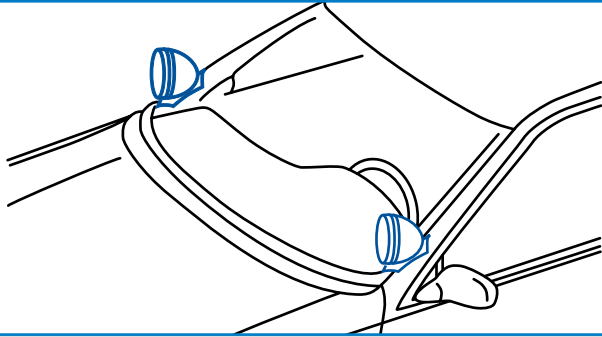

- 7X6 Spotlamp left hand, pillar-mounted unity, 6-inch with replaceable H3 halogen bulb; independently fused
- 7X7 Spotlamps left and right hand, pillar-mounted unity, 6-inch with replaceable H3 halogen bulb; independently fused
- 7X8 Spotlamp provision left hand provision for customer installed spotlamp includes hole through pillar, mounting bracket and accessible power connector
- 7X9 Spotlamp provision left and right hand includes same components as option 7X8

Note: Lamp fuses are located in the engine compartment electrical center.

HOLE IN ROOF PANEL

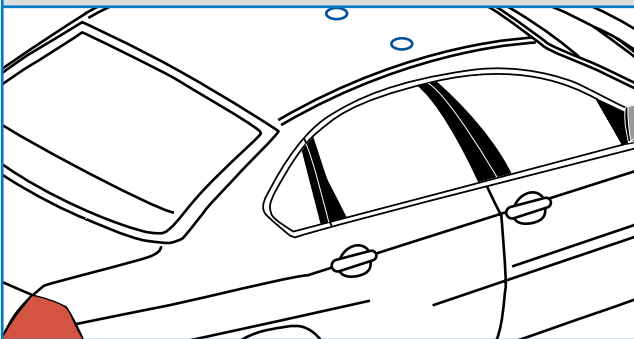

- 6B7 Hole is drilled near center line of roof panel approximately 29 inches rearward of windshield opening
- 6J5 Hole is drilled on passenger side of roof panel approximately 29 inches rearward of windshield opening and approximately 6 inches inboard from passenger side door

Note: Only one roof hole location may be ordered. SEO 6F5 roof wiring is required when SEO 6B7 or SEO 6J5 are ordered.

AMF – PACKAGE OF 6 TRANSMITTERS

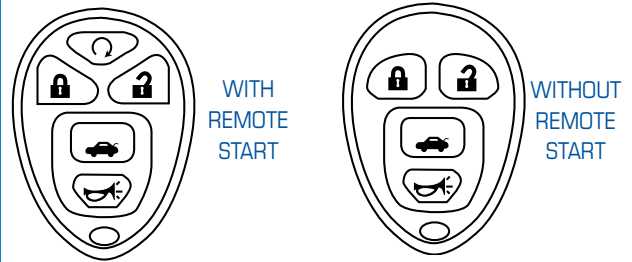

RELEARN REMOTE KEY

To access this DIC display, the vehicle must be in PARK. This display allows you to match the remote keyless entry transmitter to your vehicle. To match a remote keyless entry transmitter to your vehicle, do the following:

1. Press the vehicle information button until PRESS THE RELEARN REMOTE KEY displays.
2. Press the set/rest button. The message REMOTE KEY LEARNING ACTIVE will display.
3. Press and hold the LOCK and UNLOCK buttons not the first transmitter at the same time for approximately 15 seconds. A chime will sound indicating that the transmitter is matched.
4. To match additional transmitters at this time, repeat Step 3. Each vehicle can have a maximum of eight transmitters matched to it.
5. To exit the program mode, you must cycle the key to OFF.

NOTE: A maximum of 8 keys may be learned for a vehicle immobilizer (Passkey III+) with a random key code. Vehicles with the fleet key option (RPO 6E2 or 6E8) may have more than 8 keys learned for the particular option fleet key and must be learned using one of the original "master" keys. When programming RPO AMF additional 6 remotes transmitters, the original 2 transmitter delivered with a vehicle must also be reprogrammed at the same time.

6J7 EXTERIOR LAMP EMERGENCY FLASHING SYSTEM, HEADLAMPS, TAIL LAMPS AND BACKUP LAMPS

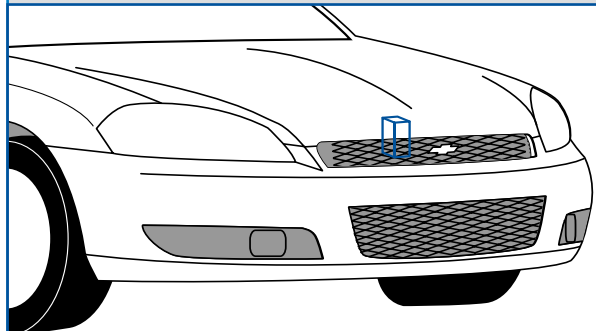

This option provides a headlamp high beam flashing module, rear lamps flashing and control wire for customer furnished ON - OFF switch, coiled in the right front foot well. The control lead may be combined with the interior wiring leads for option 6J3 when that option is ordered with option 6J7 (See also page 31).

Can specialty vehicle equipment (e.g. radar devices, video cameras, computers, meters, radio trees, shotguns, etc.) still be mounted in cars with passenger side air bags?

Yes, but care must be taken to mount the equipment outside of the deployment zone. Air bags inflate with great force and will interact with any object in the deployment zone. Therefore, to reduce the risk of injury to vehicle occupants, GM recommends that the air deployment zone be kept free of any equipment. If a piece of equipment were to become dislodged it could strike an occupant in the vehicle and result in injury. The likelihood of an object becoming dislodged is influenced by many factors, including the proximity of the object to the inflatable restraint, the size and shape of the object, and the means by which the object is secured to the vehicle. In addition to these factors, the trajectory and velocity of a dislodged object can be influenced by the type and severity of vehicle crash.

Objects that are in the deployment zone, but do not become dislodged by an inflating air bag can still affect the performance of the air bag. For example, such objects could tear the fabric or affect the shape of the air bag, thus reducing the ability of the bag to provide restraint.

Is it possible to shield equipment that is installed in the passenger side frontal air bag deployment zone in a manner that will allow full and safe air bag deployment?

Due to the complexity of influencing variables, GM is unable to evaluate the potential for shielding expected equipment configurations in all accident scenarios in order to assure that the air bag performance would be unaffected. While shielding may protect certain equipment from being damaged or dislodged, it may also negatively affect the inflation characteristics of the air bag. The air bag's shape, inflation angle, fold pattern, and inflation rate and pressure are developed to maximize the protection capability of the inflatable restraint system. Therefore, GM cannot recommend the placement of any equipment in the deployment zone, even if it is shielded to protect it from damage.

Front air bag systems and instrument panel mounted equipment.

Passenger air bags in GM vehicles deploy in different ways depending upon the type of vehicle and the particular instrument panel design.

In some vehicles, the passenger air bag deploys through a discrete door located on the top surface of the instrument panel (top-mount air bag systems). In other vehicles, such as the Chevrolet Tahoe, the passenger air bag deploys through a discrete door mounted on the vertical rearward surface of the instrument panel, above the glove box door (mid-mount air bag system). With these types of top-mount and mid-mount passenger air bag systems, the top pad of the instrument panel remains in place during deployment.

Some GM passenger air bag systems, like the system in the Chevrolet Impala, deploy from beneath the instrument panel top pad. These are considered 3/4-mount air bag systems with a "deployable top pad." The entire instrument panel top pad is the "deployment door" from under which the inflating air bag emerges. When an air bag deployment is commanded, the forces from the inflating passenger air bag push up on the instrument panel top pad, releasing special fasteners across the rearward edge of the top pad. This allows the top pad to rotate upward so that the passenger air bag may emerge. The top pad rotates upward to open widest at the right hand side, and is usually forced upward into contact with the windshield on the right hand side of the vehicle during a deployment.

Head curtain side air bags are designed to help reduce the risk of head and neck injuries to front and rear seat occupants on the near side of certain side-impact collisions. Always use safety belts and the correct child restraints for your child's age and size, even in vehicles equipped with air bags. Children are safer when properly secured in a rear seat. See your vehicle Owner's Manual and child safety seat instructions for more information.

Instrument panel top mounted special equipment, such as a radar antenna and control unit or video camera must be positioned to the left of the vehicle center line. This equipment must be mounted as low as possible and securely fastened to the top pad to avoid being dislodged in the event of a crash and possible air bag deployment. In the process of securely fastening special equipment to the top, DO NOT fasten down the top pad itself to any other vehicle component such as the cluster trim plate. As described above, the top pad rotates upward during a deployment. In order to enable the proper deployment of the passenger air bag, specialty equipment installation MUST NOT PREVENT the top pad from rotating upward during deployment. Location and attachment of special equipment should minimize added resistance or interference to upward rotation of the top pad during deployment.

Optional side air bags for crashes to the vehicle sides.

The air bag system in your police vehicle may include optional side air bags for front and rear occupants. Most front-to-rear side air bags are designed to deploy downward from the interior roof sides to the bottom of the door windows.

Can Specialty Vehicle Security Barriers be mounted within the side air bag deployment zones?

No. The side air bags inflate extremely fast because of the nature of side crashes to the vehicle. Mounting a security barrier behind the front seats with the ends placed within the side air bag deployment zones will result in unintended interaction between the barrier and the inflating side air bags. To reduce the risk of injury to the vehicle occupants, GM recommends that the side air bag zones be kept free of any customer installed equipment.

Customer furnished equipment installed to the vehicle roof.

Your police vehicle is designed with an interior roof cover system which includes internal components for the interior lamps and wiring. The roof system may also include optional side air bag components. Inflation devices may be mounted on the vehicle roof side behind the rear doors as well as air bag tethers retained to the windshield pillars. Care must be taken to avoid damage to these components or interference with their operation when installing roof mounted equipment such as emergency lamps and communication antennas.

Recommended GM service procedures must be followed to remove and re-install the instrument panel top pad to ensure that the top pad will release properly in the event of a passenger air bag deployment.

On the right half of the top pad closest to the passenger air bag module, GM recommends that no equipment be mounted. When mounting equipment on the driver side of the top pad, GM recommends that the total mass of the top pad mounted special equipment not exceed 8 pounds (3.6 kilograms), since the top pad tends to rotate about the left end.

Fasteners used to secure special equipment to the instrument panel top pad, the windshield glass, or to the windshield upper frame (header), should be selected to ensure that these devices will remain attached during a vehicle crash and possible air bag deployment.

Can the installation of push bumpers on the front end of the vehicle affect the deployment of the air bag?

General Motors is not aware of adverse effects during crash events from the many push bumpers that have been installed on GM police vehicles. Because there are many styles of push bumpers available with varying crash characteristics, installation of push bumpers may or may not affect deployment timing of the air bags. Push bumpers should be mounted to avoid modifying the vehicle structure and interfering with the front air bag sensors mounted on the upper radiator support cross member.

Two front impact sensors are installed in General Motors vehicles. Do not relocate or disconnect the front sensors. The location and orientation of the front sensors are critical for correct operation of the air bag system. Avoid mounting components on or near the sensors. Push bumper styles with vertical pushing members that are in fore-aft alignment with the front air bag sensors are not recommended.

How long will the air bag remain inflated?

It takes approximately 1/20th of a second to fully inflate the frontal air bags. This is faster than the blink of an eye. The air bags begin to deflate immediately, helping to stop the occupants more gradually.

Can the air bag system be re-used?

No. The air bags are designed to inflate only once. After inflation some new parts will be required. These will include the air bag module and possibly other parts. (A competent service technician with access to the vehicle's service manual and the required tools should replace the required components after a deployment crash.)

I've heard that the dusts that are released into the passenger compartment from the air bag are harmful. Is this true?

For most people, the only effect the dusts will produce is some irritation of the throat and eyes, and that is only if the occupant remains in the vehicle for many minutes after the air bag deployment with no ventilation and windows closed. However, some people with asthma may develop an asthmatic attack from inhaling the dusts. If this happens, they should first treat themselves the same way their doctor has advised them to treat any other asthma attack, and then immediately seek medical treatment.

When should an air bag inflate?

The driver's and right-front passenger's frontal air bags are designed to inflate in moderate to severe frontal or near-frontal crashes. But they are designed to inflate only if the impact speed is above the system's designed "threshold level."

In addition, if your vehicle has "dual stage" frontal air bags, these air bags tailor the amount of restraint according to crash severity. For moderate frontal impacts, the air bags inflate at a level less than full deployment. For more severe frontal impacts, "dual stage" frontal air bags deploy at full levels.

If the front of your vehicle goes straight into a wall that doesn't move or deform, the threshold level of the reduced deployment is about 12 to 16 mph (19 to 15 km/h), and the threshold level for a full deployment is about 18 to 24 mph (29 to 28.5 km/h). The threshold level can vary, however, with specific vehicle design, so that it can be somewhat above or below this range.

If your vehicle strikes something that will move or deform such as a parked car, the threshold level will be higher. The driver's and right-front passenger's frontal air bags are not designed to inflate in rollover, side impacts, or rear impacts, because inflation would not help the occupant.

Seat mounted side impact air bags are designed to inflate in moderate to severe side crashes. The side impact air bags will inflate if the crash severity is above the designed "threshold level." The threshold level can vary with specific vehicles design. The side impact air bags are not designed to inflate on frontal or near-frontal impacts or rear impacts, because inflation would not help the occupant.

Roof rail mounted head-curtain air bags are designed to inflate in moderate to severe side crashes. In addition, certain vehicles have head-curtain air bags which are also designed to inflate in situations where an impending rollover condition is identified by the vehicle's rollover sensing system and/or frontal or near-frontal impacts if the crash severity is above the designed "threshold level".

Safety belt pretensioners at the driver and front passenger seat positions are designed to deploy in frontal, near-frontal, side, and rear crashes that exceed the "threshold level" of crash severity to help reduce slack in the safety belt. Safety belt pretensioners will also deploy in impending rollover situations.

I've heard that a deployed air bag produces what appears to be smoke. Is the air bag hot?

After the bag has deployed in a crash, the air bag itself will not be hot to touch. Some components within the air bag module will be hot for a short time. A small amount of smoke coming from a deployed air bag module is normal and should not be cause for concern.

Also, when the nitrogen gas is vented out of the air bag, small particles from inside the bag are also vented into passenger compartment. These airborne particles look like smoke and some particles are deposited as residue on and around the air bag.

If my vehicle has air bags, why should I have to wear my safety belt?

Air bags are in many vehicles today and will be in most of them in the future. But they are supplemental systems only; so they work with safety belts - not instead of them. Every air bag system ever offered for sale has required the use of safety belts. Even if you're in a vehicle that has air bags, you still have to buckle up to get the most protection. That's true not only in frontal collisions but especially in side and other collisions.

FRONT COMPARTMENT PLAN VIEW

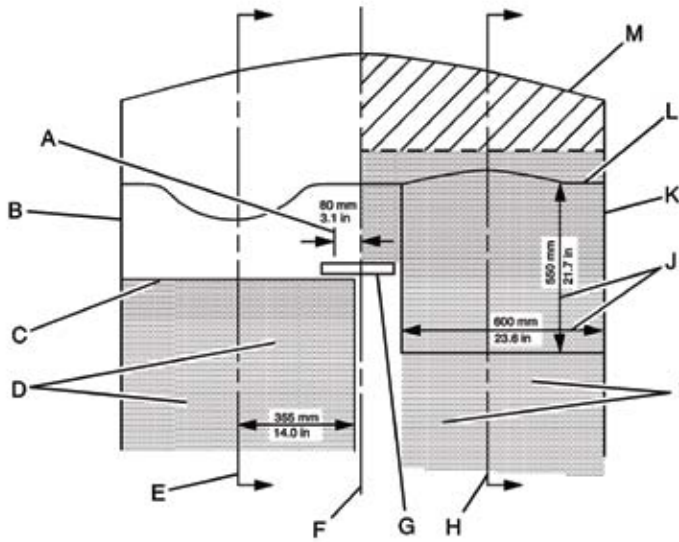

TOP VIEW OF INSTRUMENT PANEL AND APPROXIMATE DEPLOYMENT AREA OF THE AIR BAG ZONE

- A. Shift selector arc
- B. Driver side door
- C. Front of steering wheel (in maximum downward position)
- D. Driver air bag deployment zone
- E. Driver centerline (also see side view)
- F. Vehicle centerline
- G. Inside rearview mirror
- H. Passenger centerline (also see side view)
- I. Passenger air bag deployment zone
- J. Approximate maximum dimension of inflated air bag
- K. Passenger side door
- L. Rear edge of instrument panel top pad
- M. Zone from instrument panel top to windshield

FRONT COMPARTMENT SIDE VIEWS

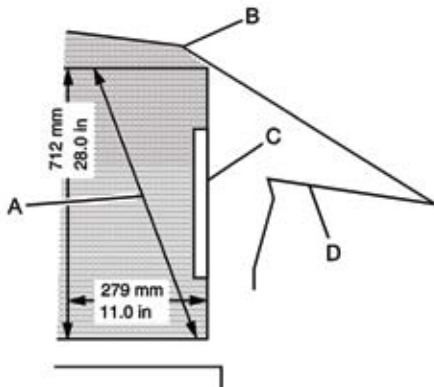

SIDE VIEW OF DRIVER SIDE AIR BAG DEPLOYMENT ZONE - CENTERLINE OF DRIVER

- A. Driver air bag deployment zone
- B. Top of windshield
- C. Front of steering wheel (maximum downward position)
- D. Top of instrument panel

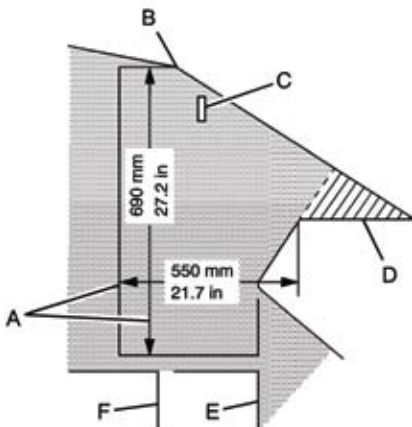

SIDE VIEW OF PASSENGER SIDE AIR BAG DEPLOYMENT ZONE - CENTERLINE OF PASSENGER

- A. Passenger air bag deployment zone
- B. Top of windshield
- C. Inside rearview mirror
- D. Top of instrument panel
- E. Passenger seat in foremost position
- F. Passenger seat in rearmost position

Head curtain side air bags are designed to help reduce the risk of head and neck injuries to front and rear seat occupants on the near side of certain side-impact collisions. Always use safety belts and the correct child restraints for your child's age and size, even in vehicles equipped with air bags. Children are safer when properly secured in a rear seat. See your vehicle Owner's Manual and child safety seat instructions for more information.

26 | AIR BAG DIMENSIONS – IMPALA 9C1 AND 9C3

HEAD CURTAIN AND FRONT SEAT-MOUNTED SIDE IMPACT AIR BAG DEPLOYMENT ZONE RIGHT SIDE SHOWN, LEFT SIMILAR

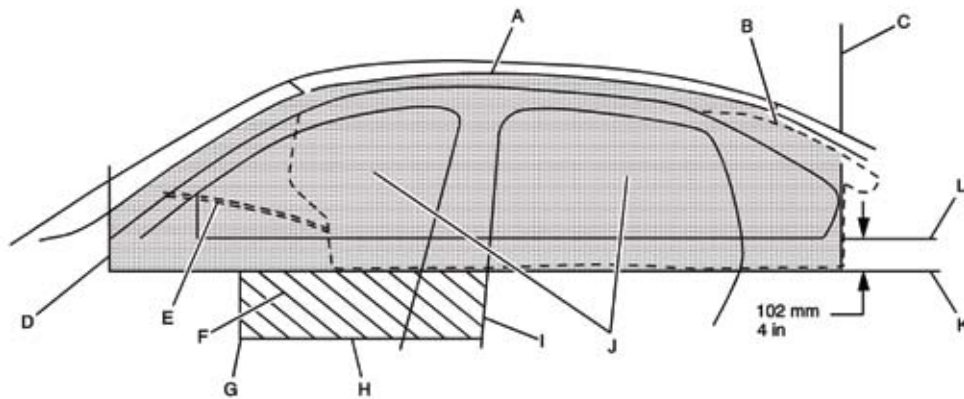

- | | |
|---|--|
| A. Top of deployment zone - along head curtain at edge of headliner | G. Door handle front end |
| B. Air bag inflator location on sail panel | H. Groove in front door armrest |
| C. Back of deployment zone - at rear of quarter window | I. Pillar trim |
| D. Front of deployment zone - at front of outside mirror patch | J. Approximate shape of deployed air bag at maximum size |
| E. Forward air bag tether line | K. Bottom of deployment zone |
| F. Thorax air bag deployment zone | L. Bottom of door windows |

HEAD CURTAIN AND FRONT SEAT-MOUNTED SIDE IMPACT AIR BAG DEPLOYMENT ZONES VIEW FROM REAR SEAT

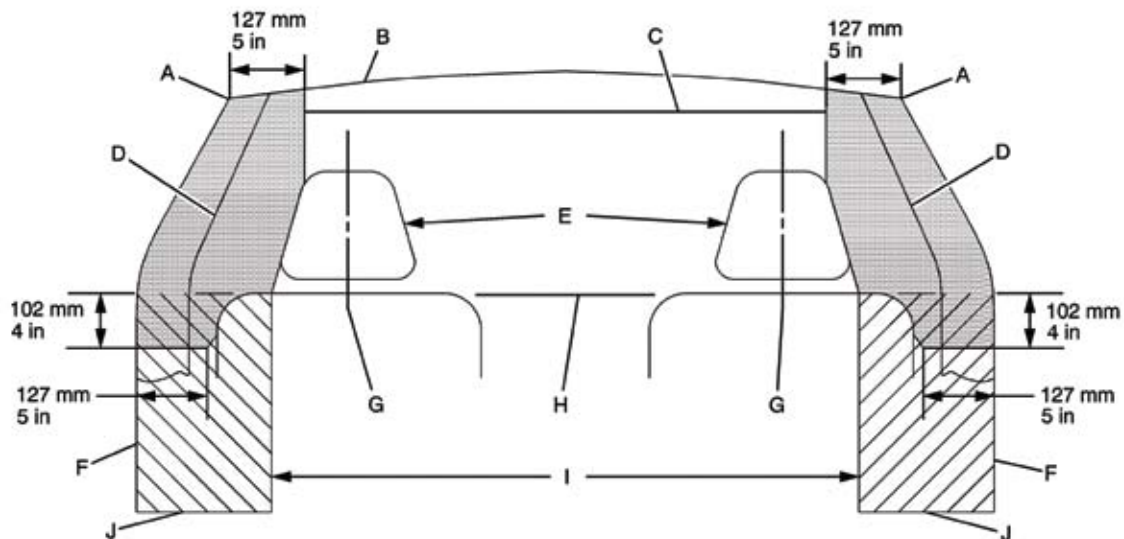

- | | |
|---|--|
| A. Edge of headliner | F. Inner door pad |
| B. Underside of headliner | G. Seat centerline |
| C. Head curtain air bag deployment zone | H. Bottom of door windows |
| D. Inner center pillar trim | I. Thorax air bag deployment zone - front seat |
| E. Headrest | J. Groove in front door armrest |

Head curtain side air bags are designed to help reduce the risk of head and neck injuries to front and rear seat occupants on the near side of certain side-impact collisions. Always use safety belts and the correct child restraints for your child's age and size, even in vehicles equipped with air bags. Children are safer when properly secured in a rear seat. See your vehicle Owner's Manual and child safety seat instructions for more information.

Note: All dimensions are approximate and subject to change.

CHIME LEVEL ADJUSTMENT

Impala police vehicles are equipped with a radio that provides an AM/FM stereo with a CD player. The radio produces a Federally mandated audible warning notification for the vehicle. The volume level of the chimes can be adjusted to be louder, but cannot be turned off.

The sound for the warning chimes is directed to the left front door speaker. When option WX7 (wiring provisions for the front speakers) is installed, the sound is directed to the left rear speaker.

See “Climate Controls” and “Audio Systems” in your Impala owner’s manual to adjust the chime volume or contact your dealer for assistance.

RADIO SUPPRESSION

Impala police vehicles are equipped with spark plugs and spark plug wires designed to reduce radio interference noise levels which may affect communication equipment, including operating frequencies in the 38-MHz to 58-MHz range.

WIRING PROVISIONS FOR 12-VOLT BATTERY POWER SUPPLY

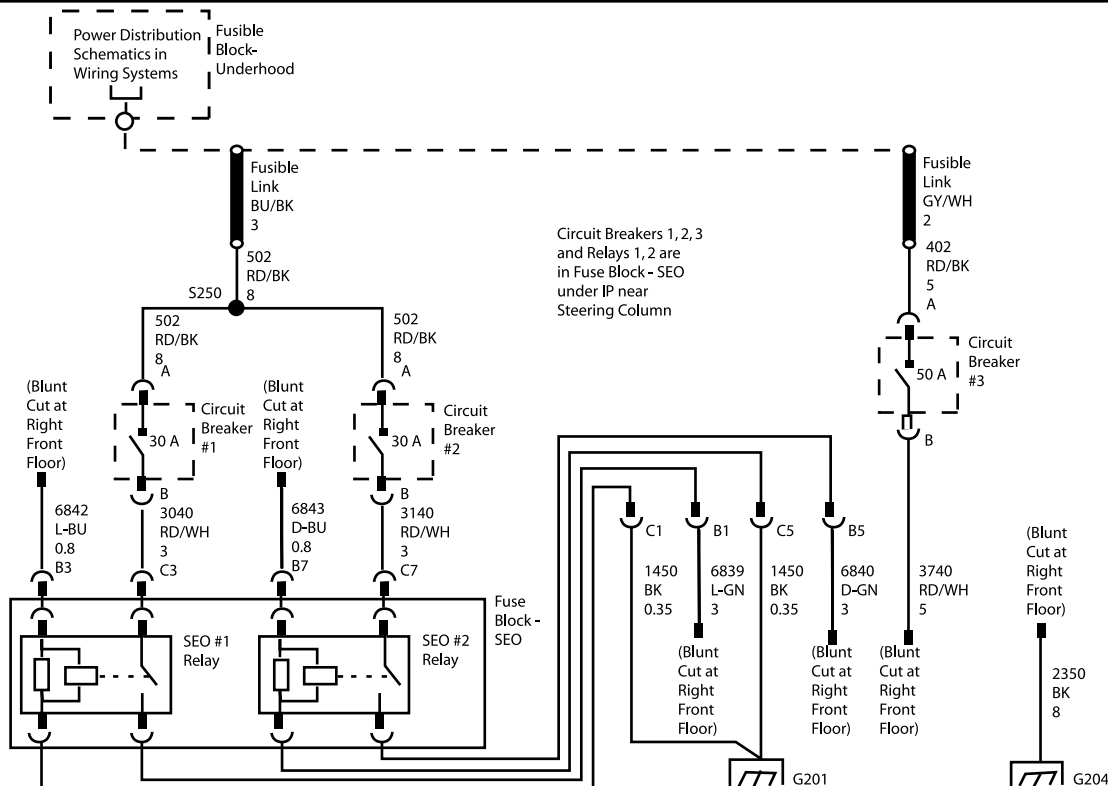

Battery power is supplied through two fusible links, one 50-amp and one 65-amp, to three circuit breakers and two control relays located in the relay center above the accelerator pedal. A 50-amp circuit breaker feeds power directly from the 50-amp fusible link through a 10-gauge (5.0 mm²) blunt cut wire. Two 30-amp circuit breakers supply power from the 65-amp fusible link through the contacts of the control relays to 12-gauge (3.0 mm²) blunt cut wires. The blunt cut leads are part of a 5-foot (1.5 m)

loop of wire coiled under the instrument panel in the passenger’s side footwell. Each relay is operated by an 18-gauge (0.8 mm²) blunt cut, light or dark blue control lead included in the 5-foot (1.5 m) coil under the instrument panel. An 8-gauge (8.0 mm²) ground lead is also provided in the 5-foot (1.5 m) coil. The total current available through the 12-volt power supply is 110-amperes (1320-watts).

Note: Wiring diagrams for these options are shown in the Police Package owner’s manual supplement (shipped in glove box).

CONTROLLED POWER AND SIGNAL CIRCUITS WITH 12-VOLT POWER SUPPLY

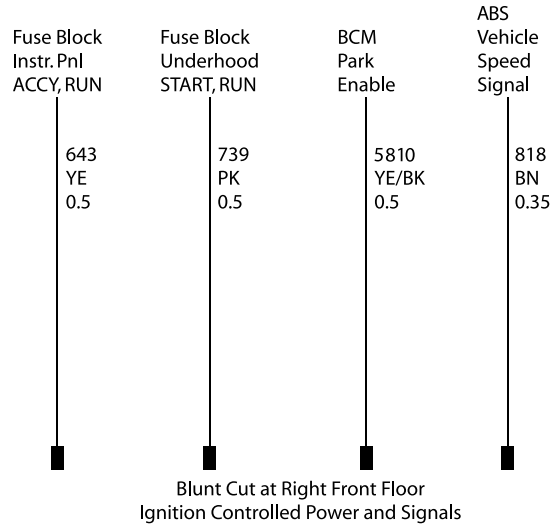

Bunt cut ignition controlled power and signal circuits are also included in the following 5-foot (1.5 m) right foot loop. The spotlamp fuses are located in the passenger's side underhood fuse block. See "Fuses and Circuit Breakers" in your owner's manual index for more information.

- A yellow, 20-gauge (0.5 mm²) 10-amp fused circuit, HOT in ACCESSORY, RUN or RAP (Retained Accessory Power) Fuse "RAP" is in the end of the instrument panel.
- A pink, 20-gauge (0.5 mm²) 10-amp fused circuit, HOT in START/RUN. Fuse "PWR Drop/CRNK" is in the underhood fuse block.
- A yellow/black, 20-gauge transaxle park signal from the Body Control Module (BCM). This circuit provides switched power (12-volts) when the transmission is not in PARK (P) and the engine is running. The electrical load attached to the park circuit must not exceed 0.5-amps (one relay coil).
- A brown, 22-gauge (0.35 mm²) vehicle speed signal (4,000 pulses/mile) from the ABS module. Connect only high impedance load.

FUSE BLOCK BATTERY POWER SUPPLY

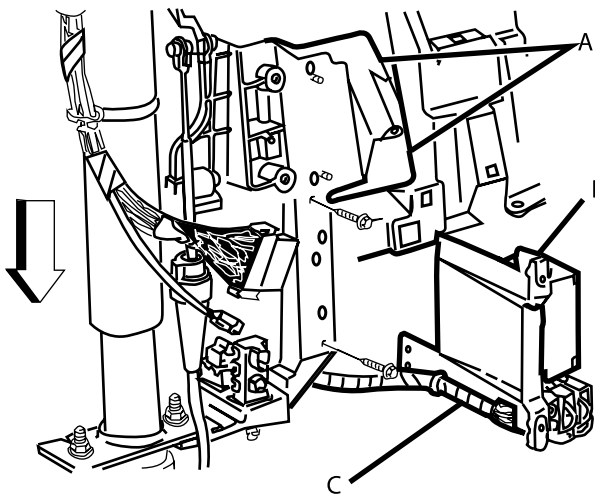

SERVICING RELAYS AND CIRCUIT BREAKERS

The following information shows you where the relays and circuit breakers are located in the fuse block.

- A. Instrument panel carrier
- B. Relay center for circuit breakers and control relay
- C. Instrument panel harness branch

ENLARGED VIEW OF THE BATTERY POWER FUSE BLOCK

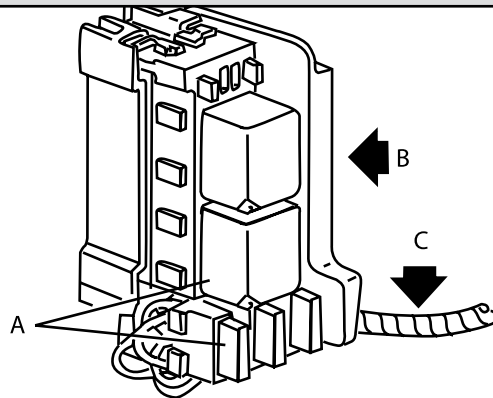

- A. Relays and circuit breakers
- B. Front of the vehicle
- C. Floor of the vehicle

Note: Wiring diagrams for these options are shown in the Police Package owner's manual supplement (shipped in glove box).

TRUNK AUXILIARY BATTERY POWER JUNCTION BLOCK

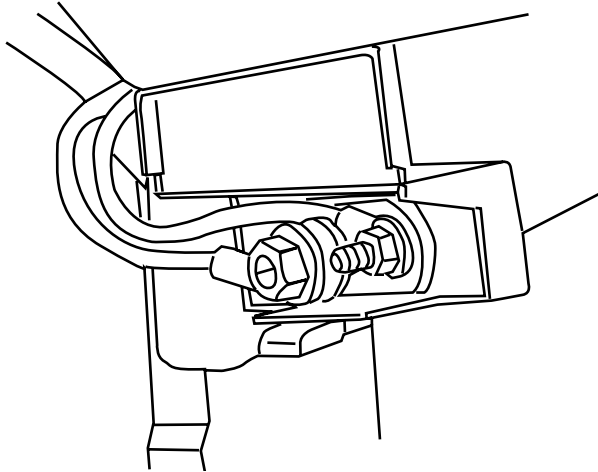

The auxiliary battery power junction block is mounted in the trunk of your Impala police vehicle. It is located on the passenger side support strut behind the rear wheel housing.

This junction block is split to provide two circuits and can be used to connect customer-furnished equipment directly to the battery through 8-gauge (8 mm²) body wiring and fusible links. A maximum of 100-amps (1200-watts) can be connected. Torque the connections to the studs to 11 lb.-ft. (15 N-m). It is fed by two fusible links of 50-amps each.

To connect the customer-furnished equipment at the junction block, use the following steps:

1. Disconnect the negative (-) battery cable.
2. Connect the customer-furnished equipment positive leads to the junction block terminals and tighten to 11 lb.-ft. (15 N-m). The ignition must be turned off and the vehicle vacated prior to connecting the negative (-) battery cable to the battery.
3. Reconnect the negative (-) battery cable to the battery.
4. Set the time on the clock and radio push buttons as needed. See "Audio Systems" in the "Instrument Panel" section of your Impala owner's manual for more information.

TRUNK GROUND STUD

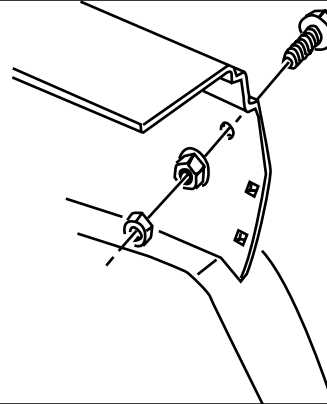

A 10 mm ground stud can be found in the trunk on the passenger's side of the vehicle. The stud is located above the trunk auxiliary junction block. See "Trunk Auxiliary Battery Power Junction Block" for more information on location. A 10 mm flanged hex nut grounds the 10 mm bolt to the vehicle. Recommended torque for the flanged nut is 26 lb.-ft. (35 N-m), plus or minus 4 lb.-ft. (5 N-m). A 10 mm hex nut is provided for customer ground termination. Recommended torque for the terminal connection nut is 7.3 lb.-ft. (10 N-m), plus or minus 1 lb.-ft. (1.3 N-m).

WIRING DIAGRAM FOR AUXILIARY BATTERY POWER JUNCTION BLOCK

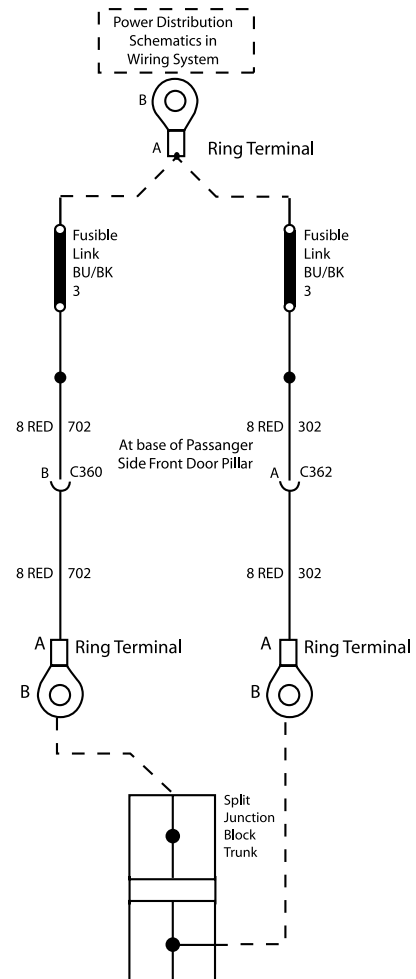

Note: Wiring diagrams for these options are shown in the Police Package owner's manual supplement (shipped in glove box).

WIRING PROVISIONS FOR VEHICLE GRILLE LAMPS AND SPEAKER/SIREN – OPTION 6J3 AND 6J7

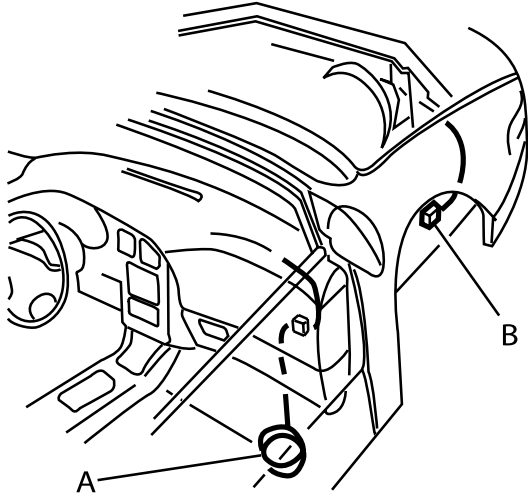

- A. Blunt cut ends for the customer-furnished grille lamps and customer-furnished siren/speaker
- B. Control wires from in-line connector in forward lamp harness for customer-furnished grille lamps and speaker

The SEO 6J3 wiring provision has a 5-foot (1.5 m) harness coiled underneath the instrument panel on the passenger side. The wiring circuits are routed from under the instrument panel to a 1-foot (30 cm) coil secured in the area behind the grille. There are four 16-gauge (1.0 mm²) wires for connecting to the grille lamps (GRY, TAN) and siren speaker (LT BU, LT GN)

The SEO 6J3 wiring provision also includes one 18-gauge (0.8 mm²) control wire for the SEO 6J7 exterior lamps Emergency Flashing System.

When option 6J7 is installed without option 6J3, only the dark green/red control wire is provided for connection to customer-furnished 12-volt switching to turn the Emergency Flashing System on or off.

WIRING DIAGRAM FOR OPTION 6J3 AND OPTION 6J7

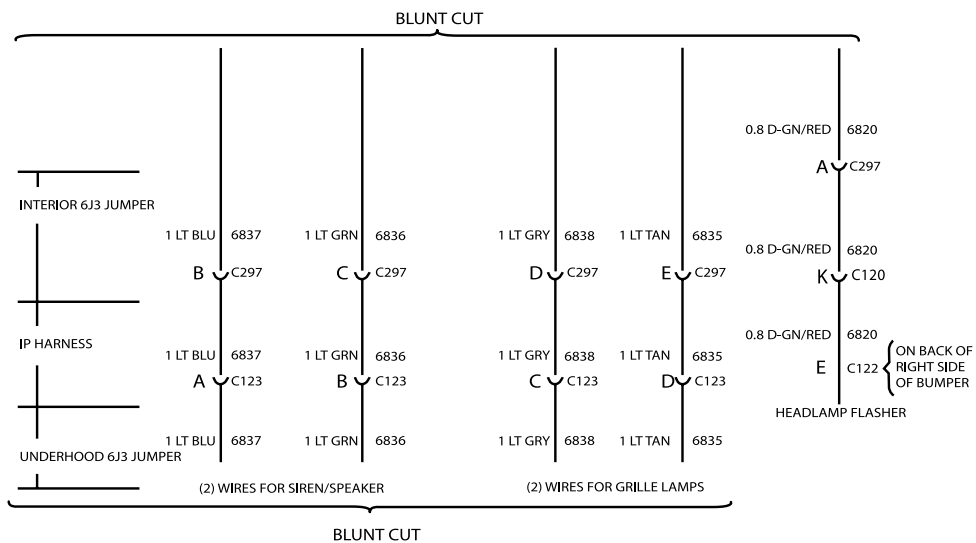

Note: Wiring diagrams for these options are shown in the Police Package owner's manual supplement (shipped in glove box).

EXTERIOR LAMP EMERGENCY FLASHING SYSTEM – OPTION 6J7

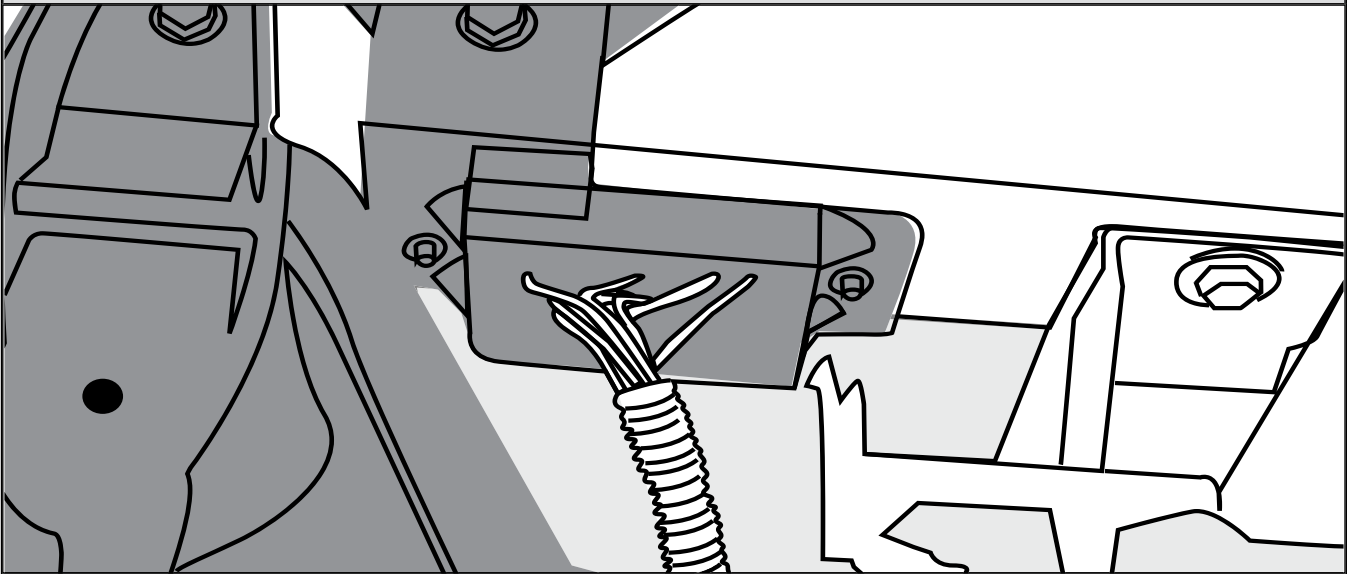

Option 6J7 provides a high beam headlamps flashing module, rear lamps flashing and control wire for a customer-furnished switch to turn the module on or off. The flasher control wire is coiled in the passenger's side footwell under the instrument panel. This control lead may be combined with the interior wiring leads for option 6J3 when that option is ordered with option 6J7.

The headlamps flashing module is located at the inboard end of the passenger's side headlamps assembly. The headlamps flashing module is activated by the application of 12-volts to a dark green/red wire coiled in the passenger's side footwell. When activated, the driver's and passenger's side high beam headlamps and the high beam instrument panel cluster lamps will flash alternately at 2.4 flashes per second.

During daylight conditions, the Daytime Running Lamps (DRL) are automatically turned off whenever the headlamps flasher module is activated. During nighttime conditions, the low beam headlamps turn on automatically while the high beam headlamps flash. Turning on the high beam headlamps manually with the turn signal/multifunction lever will override the flashing module and the high beam headlamps will operate continuously.

A fuse labeled HDLP MDL protects the flasher module circuit. This fuse is located in the underhood fuse block in the engine compartment on the passenger's side of the vehicle. See "Fuses and Circuit Breakers" in the "Service and Appearance Care" section of your Impala owner's manual for more information.

When the headlamps flashing module is turned on, the module sends a signal to the Body Control Module (BCM). The BCM alternately flashes the stop lamps and backup lamps. Depressing the brake pedal will override the stop lamp flashing and placing the transaxle in reverse will override the backup lamp flashing.

Activation of the headlamp and rearlamp flashing can be separated.

When it is dark outside, the tail lamps will turn on automatically. The Center High-Mounted Stop lamp (CHMSL) will not flash and will operate only when the regular brake pedal is pressed.

FORWARD LAMP HARNESS IN-LINE CONNECTOR FOR USE WITH HEADLAMPS FLASHER MODULE, OPTION 6J7

			C122		
GROUND	1250	0.8 BLK	A	<	
LH HI BEAM	711	0.35 D-GN/WH	B	<< B	0.35 D-GN/WH
POWER*	2940	0.8 RD/WH	C	<	
RF HI BEAM	311	0.5 L-GN/BK	D	<< D	0.5 L-GN/BK
CONTROL	6820	0.35 D-GN/RD	E	<	
BCM	6841	0.5 D-BU/YE	F	<	

* FUSE "HDLP MDL", FUSE BLOCK, UNDERHOOD

This connector is located at the rear passenger side of the bumper beam.

Note: Wiring diagrams for these options are shown in the Police Package owner's manual supplement (shipped in glove box).

WIRING DIAGRAM FOR OPTION 6J4

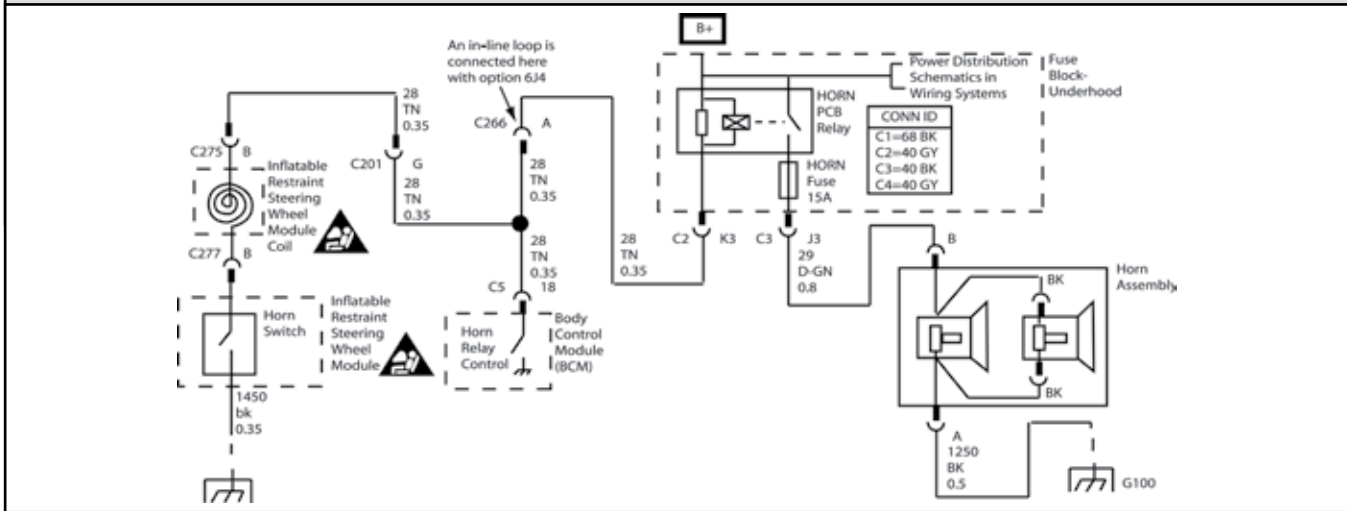

WIRING PROVISION FOR HORN/SIREN CIRCUIT – OPTION 6J4

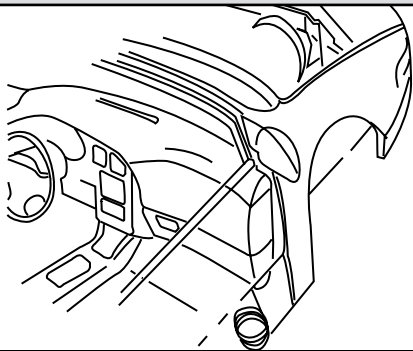

This provision permits customer connection of a switch to select either horn or siren operation when the horn pad is pressed.

A 22-gauge (0.35 mm²) wire is connected to an in-line connector in the horn circuit of the instrument panel harness under the instrument panel. The end of this harness extension is in a 5-foot (1.5 m) loop of wire coiled under the instrument panel.

WIRING DIAGRAM FOR ROOF-MOUNTED ACCESSORIES – OPTION 6F5

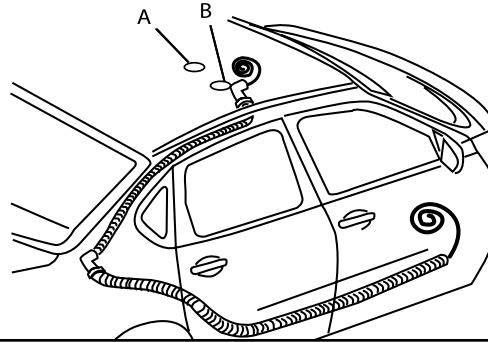

Option 6F5 is a universal wiring harness for roof-mounted equipment. The harness is routed from a 5-foot (1.5 m) coil of wire in the passenger's side footwell to a connector on the passenger's side of the trunk.

When the option 6B7 (center hole) is ordered, two color coded 10-gauge (5.0 mm²) wires extend 24-inches (60 cm) through a grommet approximately 30-inches (74 cm) behind the top of the windshield at the center of the roof.

When option 6J5 (passenger's side hole) is ordered, two color-coded 10-gauge (5.0 mm²) wires extend 24-inches (60 cm) through a grommet approximately 30-inches (74 cm) behind the top of the windshield and 6-inches (15 cm) inboard from the passenger's side roof joint.

WIRING DIAGRAM FOR OPTION 6F5

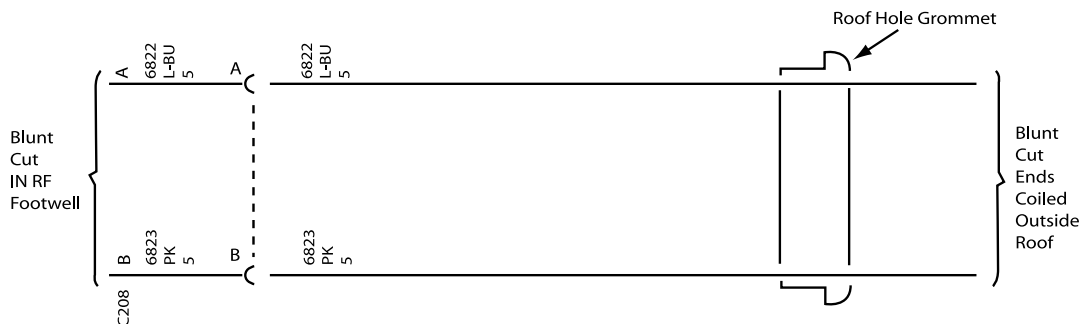

WIRING PROVISION FOR FRONT SPEAKERS – OPTION WX7

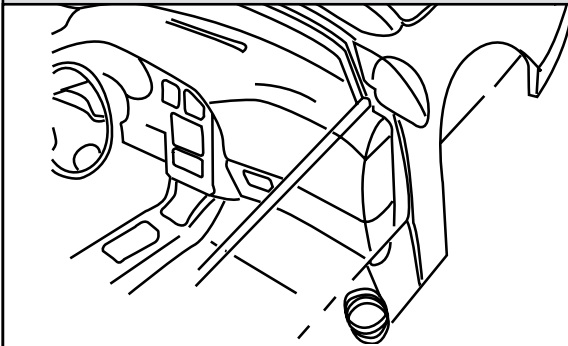

Approximately 60 inches (1.5 m) of auxiliary speaker wiring is routed from the front door and windshield pillar speakers and coiled under the instrument panel. The wiring permits connection of the front speaker pairs to customer-installed communication equipment. Vehicle radio front speaker outputs are re-routed to the rear speakers to maintain the required open door/key-in-ignition audible warning.

WIRING DIAGRAM FOR OPTION WX7 IN-LINE CONNECTOR

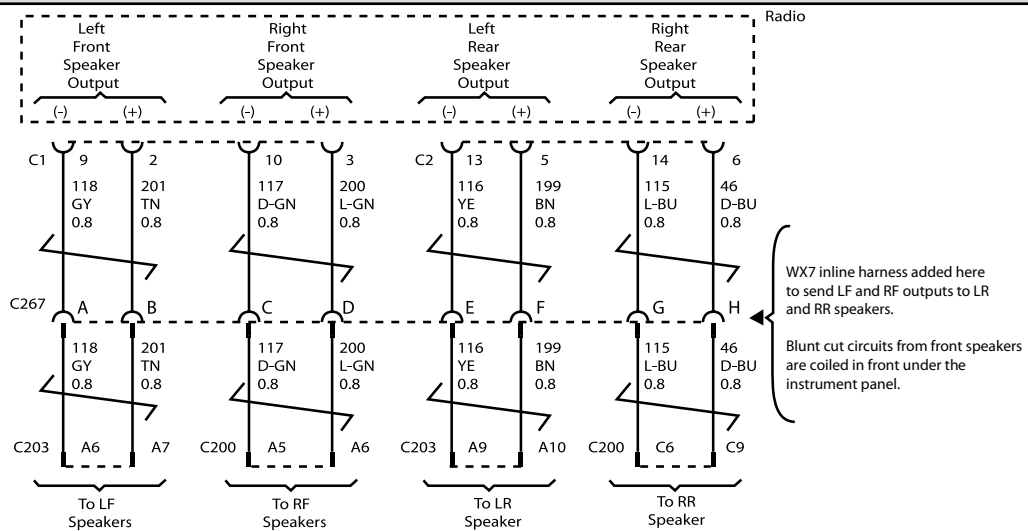

Note: Wiring diagrams for these options are shown in the Police Package owner's manual supplement (shipped in glove box).

GM offers Anti-Lock Brake Systems as standard or optional on all North American passenger vehicles and light truck lines. The computerized Anti-Lock Braking System (ABS) is designed to keep the vehicle's wheels rotating as the brakes are applied to assist the driver in achieving a controlled stop. Sensors monitor how fast the wheels rotate and feed the data continuously to the ABS computer. The vehicle's brakes slow each wheel as the brake pedal is applied. However, when ABS is activated due to road conditions, the system repeatedly releases and applies pressure to the brakes. The wheels can keep rolling, thus retaining steering ability and enhanced stability while providing a higher braking force on most surfaces than a locked wheel provides.

How exactly does ABS work?

In cars without ABS, hitting the brakes can cause the wheels to lock, leaving you unable to steer the vehicle until you decrease the pressure so the wheels can roll again. With an ABS, as you apply the brakes, the ABS computer monitors the wheel speed sensor information. If the computer senses that a wheel is approaching lock up, it sends a signal to the hydraulic modulator to reduce, then to reapply, brake pressure several times a second for as long as you maintain firm pressure on the brake pedal. The process is much like the threshold braking technique used with conventional brakes. However, ABS does it much faster and more accurately than any driver can, leaving you free to focus on steering away from obstacles.

Does ABS reduce stopping distances?

Yes, in braking situations where the wheels on a non-ABS equipped vehicle would lock up, ABS will generally provide shorter controlled stopping distance. The amount of improvement in stopping distance depends on many factors, including the road surface, severity of braking, initial vehicle speed, etc. On some surfaces, such as gravel roads, braking distances can be longer, but you will still have the control benefits of ABS. The important capability of ABS is control. ABS provides improved vehicle steerability and stability when braking.

What can affect the ABS advantage?

It is important that you follow the maintenance schedule recommended in the owner's manual of the vehicle, tires should be at their proper inflation level, the brake pads should be checked regularly, etc. While driving, you should sit comfortably, so that your hips are back in the seat and your knees are bent, even while braking. Your foot should be positioned so that your heel is on the floor and your toes are secure on the lower half of the pedal. And, though ABS may reduce stopping distance, remember: The faster you go, the longer it takes you to stop. Keeping a safe distance between you and the vehicle in front of you is always necessary, even with ABS.

What happens if ABS becomes inactive?

The ABS electronic control unit has on-board diagnostic capability. If a fault is detected, the vehicle will revert to the base brake system, and the ABS telltale on the dash will be illuminated. Should this happen, the vehicle should be taken to a dealership for repair as soon as possible.

How do I use ABS?

Depress and hold the pedal. DO NOT PUMP THE BRAKES (that prevents the system from working). Just hold the brake pedal down and let the ABS work for you. You may feel the brake pedal vibrate, or you may notice some noise, but this is normal as the system works for you.

Should I drive an ABS equipped vehicle differently than I would drive a vehicle with conventional brakes?

Most of the time, under normal driving circumstances, there is no difference, and you should always drive with the same caution and care. It is important to realize that ABS only makes a difference when it is activated—when you have to brake hard—and that would only be when the computer senses that a wheel is approaching lock up. When ABS activates keep steady pressure on the brake pedal and then let the ABS work for you. Don't pump the brakes or try to find the threshold. Simply hold the brake pedal down and steer if necessary to avoid an obstacle.

Is ABS always active?

ABS is always available, but not always activated. ABS is activated only when the brake pedal is applied and the computer detects an impending wheel lock condition.

Can older cars be retrofitted with ABS?

No! The brake system is one of the most important features on any passenger vehicle. Several products, which tap into the master cylinder and/or brake system performance, are being sold in the aftermarket. Some of these products imply performance similar to new vehicle anti-lock brake systems.

However, contrary to their claims, add-on systems, which deplete fluid from the master cylinder on brake apply may actually increase a vehicle's stopping distance. This may cause the vehicle to fail to comply with Federal brake standards.

Does ABS always activate at the same speed?

No, the system operates when the computer detects wheel lockup, at any speed above 8 mph.

Will ABS wear out a vehicle's brakes sooner?

A properly maintained brake system will be unaffected by ABS operation under typical driving conditions.

Are there different types of ABS?

Yes, there are rear wheel anti-lock systems (RWAL) used on some trucks and four-wheel ABS available on cars and trucks.

Do Federal Safety Standards mandate ABS?

No. Federal standards establish minimum braking performance requirements that all vehicles must meet, but do not specify how they should be met. It should be noted that even a vehicle with failed ABS meets the Federal safety standard for stopping distances.

Will a tire size change affect ABS?

Use of tires other than original equipment may affect ABS performance. Owners should consult and follow the recommendations contained in the vehicle owner's manual regarding replacement tire size. *Note: ABS will work with original equipment spare tire or tire chains. However, performance is reduced.*

Do insurance companies give a discount for ABS?

Yes, many insurance companies give discounts that range from 5% to 10%. In the states of New York and Florida all insurance companies are required to give an ABS discount of 5% on certain coverages such as bodily injury, property damage, collision, and personal injury protection. In other states the discount varies from insurance company to insurance company. When buying auto insurance, always ask your insurance agent if his/her company gives a discount for vehicles equipped with anti-lock brakes.



IMPORTANT DRIVING SAFETY TIPS



- A. Always maintain a safe following distance.** ABS does not allow you to stop on a dime. (Generally a 2-second following distance is considered safe in ideal conditions.) Watch the vehicle in front of you pass a fixed marker (such as a sign). Count seconds—one-thousand-one, one-thousand-two—until your front bumper reaches the marker. If you do not count out two seconds, then you are too close to the vehicle in front of you. Also, if the roads are wet or icy, or visibility is poor, you should increase your following distance.
- B. Always drive carefully—** especially on slippery surfaces. ABS cannot create friction between the tires and the road surface, it can only give the driver the maximum advantage of the existing adhesion. If the vehicle is traveling on a surface with no adhesion, the best ABS in the world cannot provide a shorter stopping distance or good steering.
- C. It is a good idea to practice an ABS activated stop** and get the feel of the brake pedal. However, please make sure it's at a safe time with no obstacles in your path. And you only really need to try it once or twice to know what happens.

ELECTRONIC STABILITY CONTROL SYSTEMS (STABILITRAK)

StabiliTrak systems help drivers maintain control of their vehicles, especially during emergency lane changes or avoidance maneuvers. StabiliTrak uses various sensors, such as steering wheel angle, wheel speed, yaw velocity, etc., to detect any difference between the path requested by the steering wheel position and vehicle's actual path. When appropriate, the system selectively controls brakes, engine power, and even suspension settings to enhance control of the vehicle's direction and help keep it on course. Independent studies conducted by the National Highway Traffic Safety Administration, the Insurance Institute for Highway Safety, and others have found StabiliTrak to be highly effective in reducing vehicle crashes. General Motors offers StabiliTrak systems on many of its passenger car and light truck models. See your owner's manual for additional information about the operation of StabiliTrak.

Q. How do I use StabiliTrak?

A. StabiliTrak operates independently of the driver. You should continue to drive your StabiliTrak equipped vehicle with caution and care. GM's StabiliTrak system, StabiliTrak, is designed to be as seamless as possible in operation, to be part of the overall vehicle response and to make a good vehicle better

Q. How does StabiliTrak work?

A. StabiliTrak has the ability to apply control forces to the vehicle independent of the driver. StabiliTrak uses sensors to continuously compare the path indicated by the steering wheel position to the vehicle's actual path. If a discrepancy is detected, StabiliTrak selectively controls vehicle brakes and engine torque to create a yaw moment that helps restore the vehicle's actual path to the path indicated by the steering wheel position. StabiliTrak has the ability to help correct both understeer (where the vehicle is not turning as much as the steering wheel position indicates) and oversteer (where the vehicle is turning more than the steering wheel position indicates). The illustration at right shows how selective braking at a particular wheel can create a compensating yaw moment to help restore the vehicle's actual path to the path indicated by the steering wheel position.

Q. Will a tire change affect StabiliTrak?

A. Use of tires other than original equipment may affect StabiliTrak performance. StabiliTrak is designed to make the best use of available traction. The performance characteristics of the original equipment tires are part of the overall system effectiveness. When you replace tires check the recommendations in your Owners Manual. On GM vehicles, the original equipment tires have a "TPC" (Tire Performance Criteria) code on the sidewall. Replacing the tires with the same "TPC" code will help assure proper StabiliTrak performance.

UPDATES FOR 2012



NEW FEATURES

- (GAN) Silver Ice Metallic
- (89U) Crystal Red Tintcoat
- (16U) Graystone Metallic
- Autonet Mobile WiFi in-car router available (see page 19 for details)
- Hill Start Assist

DELETIONS

- (80U) Red Jewel Tintcoat
- (GGU) Steel Green Metallic
- (GGZ) Sheer Silver Metallic
- (GLF) Ice Blue Metallic
- (GGW) Taupe Gray Metallic

2 | TAHOE 2WD POLICE PACKAGE PPV

Police Package Option PPV must be ordered. The 2-wheel drive Tahoe Police Package is not intended for trailer towing. This vehicle has been designed for police work up to and including high speed emergency vehicle operations. GM restricts the sale of police vehicles and they are not to be sold to retail customers.

MODEL AVAILABILITY

CC10706 Rear-wheel drive

STANDARD EQUIPMENT SUMMARY

WARRANTY 3 years / 36,000 mile bumper-to-bumper (whichever comes first, see dealer for details)
5 years / 100,000 mile limited powertrain (whichever comes first, see dealer for details)

INTERIOR FEATURES

AIR CONDITIONING	Dual-zone manual climate control with individual climate settings for driver and front passenger; includes auxiliary rear air conditioning and heat (rear operated from front control only)
ASSIST HANDLES	Front passenger and second row outboard; front passenger assist handle is deleted when passenger side spotlamp is ordered
COMPASS	Standard
CONSOLE, FLOOR	Not available
CONSOLE, OVERHEAD	Includes map lamps
CRUISE CONTROL	Electronic with set and resume speed
DOME LAMPS	Dome lamps, cargo lamp with delayed entry feature and map lamps (see page 18 interior/exterior lamp control to turn off dome light)
FLOOR COVERING	Black vinyl floor and load floor behind second row seats
GLASS	Deep tinted (all windows except light-tinted glass on windshield, driver and front passenger side glass)
GLOVE BOX	Locking door and no light
MIRROR	Inside rearview manual day/night
ONSTAR	Not available on Police Package
OUTSIDE TEMP. DISPLAY	Standard
RADIO	AM/FM stereo with MP3 compatible CD player, seek-and-scan, digital clock, auto-tone control, Radio Data System (RDS), speed-compensated volume and theftlock
RESTRAINT SYSTEM	Tahoe received an overall 5-star frontal and side crash test rating from NHTSA¹². Safety belts, driver and front passenger with pretensioners, dual stage driver and passenger frontal air bags ¹ , passenger sensing system and frontal air bag ¹ ON/OFF indicator, rollover sensor, dual head curtain air bags ¹ for front and rear outboard occupants and front seat back mounted thorax-pelvic air bags ¹
SEATS, FRONT	Cloth bucket seats, 6-way power driver and passenger seat adjusters with manual reclining seat back and lumbar controls and adjustable head restraints
SEAT, REAR	Vinyl split-folding 60/40 bench with outboard seating position headrests, 3rd seat not available (see page 4)
SPEEDOMETER/CLUSTER	140 mph certified analog speedometer, 1 mph increments and digital trip odometer with gages for engine oil pressure, fuel, battery volts and coolant temperature. Driver Information Center displays engine hours, warnings and other information (see message listing on page 6)
STEALTH MODE	See exterior lamps control on page 18 for operation description
STEERING WHEEL	Tilt-wheel with column mounted gear shift lever
THEFT DETERRENT SYSTEM	Vehicle PASS-Key [®] III+ and content theft (unauthorized entry sounds horn and lamps flash). For content theft alarm disable option UTQ must be ordered (see page 7)
VISORS	Padded with cloth trim, extends on rod
WARNING TONES	Headlamp on, key-in-ignition, driver and right-front passenger safety belt unfasten and turn signal on
WINDOW OPERATION	Power with driver express-down and lockout features

ELECTRICAL FEATURES

AUXILIARY POWER, FRONT	100-amp ignition and main power supply wiring at lower center of instrument panel (see wiring provisions for 12-volt battery power supply on page 25)
AUXILIARY POWER, REAR	100-amp auxiliary power in cargo area (see page 27)
GROUND STUDS	Two studs located in rear compartment near bottom of liftgate opening (see page 27)
LOCK-OUT PROTECTION	Prevents the power door locks from locking the driver's door if the keys are left in the ignition (manually lockable with engine running)
POWER OUTLETS	Two located on instrument panel and one in rear cargo area
WIRING DIAGRAMS	See pages 25 through 32 for description; also see Tahoe Police Package owner's manual supplement (located in glove box folder with standard owner's manual)
WIRING PROVISION, EXTERIOR LAMPS FLASHING	Forward lamp harness in-line connector for Exterior Lamps Flashing System (see option 6J7 on page 7)

1. Head curtain side air bags are designed to help reduce the risk of head and neck injuries to front and rear seat occupants on the near side of certain side-impact collisions. Always use safety belts and the correct child restraints for your child's age and size, even in vehicles equipped with air bags. Children are safer when properly secured in a rear seat. See your vehicle Owner's Manual and child safety seat instructions for more information.
12. Model tested with standard head curtain side-impact air bags (SABs). Government 5-Star Safety ratings are part of the National Highway Traffic Safety Administration's (NHTSA's) New Car Assessment Program (www.SaferCar.gov).

EXTERIOR FEATURES

ASSIST STEPS	Black, mounted between front and rear wheels
DEFOGGER	Electric, rear window
DOOR HANDLES	Matte Black
DOOR LOCKS	Power, non-programmable with lockout protection and automatic door locking and unlocking, door lock cylinder no longer available on passenger front door and rear liftgate; child safety locks included in rear doors
FASCIA, FRONT	Body color
FASCIA, REAR	Body color - with step pad
FOG LAMPS	Not available
HEADLAMPS	Dual halogen composite with flash-to-pass feature, automatic exterior lamp control and daytime running lamps (to delete automatic lamp control see option 9GB on pages 7 and 18)
HORNS	Dual note
KEYLESS ENTRY	Includes two transmitters with non-functional panic button; stealth mode feature includes exterior lamps and horn disable; if remote start Option AP3 is included running lamps will remain illuminated (additional transmitters are available; see option AMF on page 7)
KEYS	Two-sided, random code, for ignition and driver door only
LUGGAGE RACK	Not available
MIRRORS	Outside heated power-adjustable, manual-folding, Matte Black
REAR LIFTGATE	Liftgate/liftglass with washer and wiper, and no lock cylinder on liftgate
RECOVERY HOOKS	Two front
UNDER HOOD LAMP	Not available
WINDSHIELD WIPERS	Intermittent, wet-arm with flat blade and pulse washers

CHASSIS FEATURES

AIR CLEANER	High-capacity
ALTERNATOR	160-amp with idle boost (transmission in PARK or NEUTRAL) based on battery energy level
BATTERY	Heavy-duty 730 cca with battery rundown protection (does not protect customer installed equipment)
BRAKES	Heavy-duty 4-wheel anti-lock front and rear disc with vacuum boost power assist
COOLING	Heavy-duty high capacity radiator, electric fans and extended life coolant; coolant hoses are EPDM (ethylene-propylene-diene monomer) rubber; silicone hoses are not required (coolant is DEX-COOL good for 5 years/150,000 miles, protects from -34° F to +265° F and against rust and corrosion)
ENGINE	Vortec 5300 V8 SFI with variable valve timing (VVT) active fuel management, FlexFuel ² (gasoline or E85 ethanol); top speed fuel cut-off at 139 mph; includes air conditioning wide open throttle cut off
FRAME	Full perimeter, modular with hydroformed rails
FUEL TANK CAPACITY	26 gallon (98 liters)
OIL COOLERS	Heavy-duty engine, transmission and auxiliary air-to-oil power steering (see page 17 for description)
PROP SHAFT	High speed balanced aluminum, four inch diameter
RADIO SUPPRESSION	Grounding straps, at five additional locations (see page 18 for locations)
SKID PLATE	Front underbody shield starting behind front bumper and running to 2nd cross-member protecting front underbody and oil pan
SPARK PLUGS	Extended life - iridium tip
STABILITRAK	Stability enhancement system. An advanced computer controlled system that assists the driver with directional control of the vehicle in difficult driving conditions. Each time the vehicle is started, the StabiliTrak system is fully on. StabiliTrak can be controlled by a StabiliTrak button on the instrument panel. The condition of the system is displayed by an instrument panel StabiliTrak indicator light and Driver Information Center (DIC) Messages. Push once, Traction Control is off, push again and Traction Control and StabiliTrak are turned back on
STEERING	Power, rack and pinion
SUSPENSION, FRONT	Coil-over-shock with stabilizer bar
SUSPENSION, REAR	Multi-link with coil springs, shocks and heavy-duty stabilizer bar
TIRES	Goodyear P265/60R17 all-season, V-rated, blackwall
TIRE PRESSURE MONITOR	CHECK TIRE PRESSURE spare tire includes sensor; must be programmed when mounted (see page 18)
TIRE, SPARE	Full-size spare, lockable with outside winch-type carrier mounted under frame at rear (includes TPM sensor - not programmed)
TRAILERING EQUIPMENT	Not available on Police Package (PPV)
TRANSMISSION	Enhanced calibration 6-speed automatic with overdrive, electronically-controlled transmission provides protection against over-revving the engine in low gear and a mechanical low gear blockout is not required; if a driver manually selects low gear and fails to manually upshift to high gear, the powertrain control module automatically protects the drivetrain
WHEELS	17" x 7.5" heavy-duty black steel
WHEEL CENTER CAP	Polished finish bolt-on metal

2. E85 is 85% ethanol and 15% gasoline. To see if there is an E85 station near you, go to www.gmaltfuel.com/e85-station-locator.

4 | TAHOE 2WD POLICE PACKAGE PPV

POWERTRAIN

ENGINE				TRANSMISSION		AXLE	
OPTION CODE	TYPE	DISPLACEMENT LITERS/CU. IN.	FUEL SYSTEM	OPTION CODE	TYPE	OPTION CODE	RATIO
LMG	V8	5.3/325	Active fuel management FlexFuel ² (gas or E85 ethanol)	MX0/MYC	6L80 6-speed auto. with OD	GU4	3.08

EMISSIONS - MUST BE SPECIFIED

FE9	FEDERAL EMISSIONS. Use for ordering vehicles that will be registered in all states except California, Connecticut, Maine, Maryland, Massachusetts, New Jersey, New Mexico, New York, Oregon, Pennsylvania, Rhode Island, Vermont and Washington State
YF5	CALIFORNIA EMISSIONS. Use for ordering vehicles that will be registered in California.
NE1	CT/ME/MD/MA/NJ/NM/NY/OR/PA/RI/VT/WA EMISSIONS. Use for ordering vehicles that will be registered in Connecticut, Maine, Maryland, Massachusetts, New Jersey, New Mexico, New York, Oregon, Pennsylvania, Rhode Island, Vermont or Washington State
NB8	Required when option code FE9 "FEDERAL EMISSIONS" is ordered for delivery to a dealer located in California, Connecticut, Massachusetts, Maryland, New Jersey, New Mexico, New York, Oregon, Pennsylvania, Rhode Island and Washington State for a purchaser who will be registering the vehicle outside California, Connecticut, Maine, Maryland, Massachusetts, New Jersey, New Mexico, New York, Oregon, Pennsylvania, Rhode Island, Vermont and Washington State.
NC7	Required when option code YF5 "CALIFORNIA EMISSIONS" or option code NE1 "CT/ME/MD/MA/NJ/NM/NY/OR/PA/RI/VT/WA EMISSIONS" is ordered for delivery to a dealer located in any state except California, Connecticut, Maine, Maryland, Massachusetts, New Jersey, New Mexico, New York, Oregon, Pennsylvania, Rhode Island, Vermont and Washington for a purchaser who will be registering the vehicle in one of these states or sold as permitted below under "EPA Policy on the Sale of California Emission Vehicles"
NB9	Required when option code YF5 is ordered for delivery to a dealer located in Connecticut, Maine, Maryland, Massachusetts, New Jersey, New Mexico, New York, Oregon, Pennsylvania, Rhode Island, Vermont and Washington. Required when option code NE1 is ordered for delivery to a dealer located in California.

TIRES - SPEED RATED

MANUFACTURER	QUANTITY	SIZE	SPEED RATING	TYPE
GOODYEAR	5	P265/60R17	V	All season BW







Note: Due to specific requirements for performance durability and safety, GM recommends only the original equipment tires for replacement

SEATS AND INTERIOR TRIM

		SEAT OPTIONS	EBONY
STANDARD	Front: cloth bucket with NO center console (power driver and passenger) Rear: vinyl 60/40 split-bench	A95 and 9N5 5T5	19C
OPTIONAL	Front: cloth 40/20/40 split-bench (power driver side seat only) Rear: vinyl 60/40 split-bench	AZ3 5T5	19C









2. E85 is 85% ethanol and 15% gasoline. To see if there is an E85 station near you, go to www.gmaltfuel.com/e85-station-locator.

AVAILABLE EXTERIOR COLORS

							
16U Graystone Metallic (New)	GHA Mocha Steel Metallic	89U Crystal Red* Tintcoat (New)	GAN Silver Ice Metallic (New)	41U Black	50U Summit White	51U Gold Mist Metallic	58U Black Granite* Metallic

*Actual colors may vary * Additional Charge*

SEO PAINT AVAILABLE

WA#	COLOR DESCRIPTION		SEO CODE
253A	Wheatland Yellow		9W3
334D	Dark Toreador Red		
722J	Dark Blue Metallic		9V7
5665	Blue		9V2
7941	Green		
9015	Woodland Green		9V5
9260	Victory Red		5T4
9414	Yellow		

ACTUAL COLOR MAY VARY

- Note:**
- All normally body-colored non-sheet metal parts, will be Flat Black (except Victory Red non-sheet metal parts will match)
 - SEO paint orders that contain less than five vehicles will be delayed until five unit minimum is received for batch production

6 | TAHOE DRIVER INFORMATION CENTER PPV

UNITED STATES CERTIFIED SPEEDOMETER/CLUSTER (CANADIAN SIMILAR)

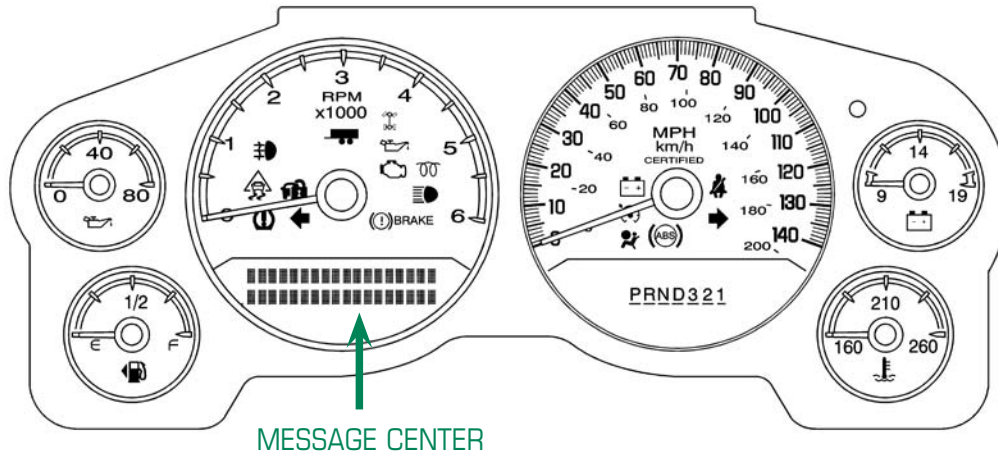

CHANGE ENGINE OIL SOON	REPLACE BATTERY IN REMOTE KEY
CHECK TIRE PRESSURE (PRESS RESET) LF/RF/LR/RR	RIGHT REAR DOOR OPEN
DRIVER DOOR OPEN	SERVICE AIR BAG
ENGINE HOT A/C TURNED OFF	SERVICE BATTERY CHARGING SYSTEM
ENGINE OIL LOW ADD OIL	ENGINE HOURS
ENGINE OVERHEATED IDLE ENGINE	SERVICE BRAKE SYSTEM
ENGINE OVERHEATED STOP ENGINE	SERVICE BRAKES SOON
ENGINE POWER IS REDUCED	SERVICE THEFT DETERRENT SYSTEM
FUEL LEVEL LOW	SERVICE TIRE MONITOR SYSTEM
HOOD OPEN	TIGHTEN GAS CAP
LEFT REAR DOOR OPEN	TIRE LEARNING ACTIVE
OIL PRESSURE LOW STOP ENGINE	TRACTION CONTROL OFF
PASSENGER DOOR OPEN	TRANSMISSION HOT IDLE ENGINE
REAR ACCESS OPEN	TURN SIGNAL ON
REMOTE KEY LEARNING ACTIVE	WASHER FLUID LOW ADD FLUID

Note: The Tahoe Police Package and Special Service Package are not equipped with DIC buttons. The instrument cluster odometer trip stem is used to display the following messages: odometer, engine hours, trip odometer, tire pressure, remote keyless entry, relearn remote key, programming and DIC language. See the Tahoe owner's manual for operation description.

SPEEDOMETER CERTIFICATION

2012 Tahoe police vehicle certified speedometer calibration. Specifications at ambient temperature of -10 to 120 degree F. Inaccuracies due to vehicle speed sensing are included.

ACTUAL VEHICLE SPEED	INDICATED SPEED
0 TO 120 MPH	+/- 2 MPH

The speedometer calibration is for the 5.3L engine, automatic transmission with a 3.08 axle and P265/60R17 H-rated tires

AVAILABLE OPTIONS WITH TAHOE PPV POLICE PACKAGE

B85	BODY SIDE MOLDINGS - On 4 doors
1LR	BRAKE SYSTEM, CITY - Uses base friction material that wears better at lower temperatures but is not optimal for track performance. The rotor does not have the radial drilled holes (again, thermal performance for track applications). Service wise these parts are physically interchangeable with their various performance trade offs.
UTQ	CONTENT THEFT ALARM DISABLE - Flashing lamps and horn warning
9G8	DELETE DAYTIME RUNNING LAMPS AND AUTOMATIC HEADLAMPS
6A6	DUAL HEAVY-DUTY 730 CCA BATTERIES - Parallel connected
9V7	EXTERIOR BODY COLORED PARTS - Dark Blue Metallic, provides Dark Blue Metallic special paint WA722J and Dark Blue Metallic special painted exterior body parts in lieu of glossy Black color normally installed with special paint. Dark Blue Metallic painted parts will consist of front fascia, rear bumper fascia, rear liftgate handle and liftgate applique above license plate. Door handles, mirrors, rear D-pillar applique and liftgate spoiler will remain Black. B85 body-side moldings are not available. Requires SEO TKG special paint
5T4	EXTERIOR BODY COLORED PARTS - Victory Red special painted exterior body parts in lieu of glossy Black color normally installed with special painted bodies, Victory Red painted parts will consist of front fascia, rear bumper fascia, rear liftgate license plate applique and rear liftgate handle, door handles and body side moldings. Mirrors, rear D-pillar applique and liftgate spoiler will remain Black. Requires SEO TKG special paint and special paint color WA9260 Victory Red. Includes RPO B85 body side moldings
6J7	FLASHER SYSTEM HEADLAMP AND TAIL LAMP - DRL compatible, headlamp flasher module with control wire and body control module rear lamp flashing
B30	FLOOR COVERING - Color keyed carpeting
B58	FLOOR MATS - Color keyed carpeted front and 2nd row (not available with vinyl floor covering)
K05	HEATER - Engine block
PPV	IDENTIFIER - Police Package
6E2	KEY COMMON - Complete vehicle fleet, provides a single key cut with a specific code that is common to the door lock and ignition of all the vehicles in the vehicle fleet; this key code is an alternate to SEO 6E8 key common, complete vehicle fleet; not compatible with 2005 and earlier Impalas, 2006 and earlier Tahoes and 2011 Caprice
6E8	KEY COMMON - Complete vehicle fleet, provides a single key cut with a specific code that is common to the door lock and ignition of all the vehicles in the vehicle fleet; this key code is an alternate to SEO 6E2 key common, complete vehicle fleet; not compatible with 2005 and earlier Impalas, 2006 and earlier Tahoes and 2011 Caprice
AMF	KEYLESS ENTRY TRANSMITTERS - Fleet Package includes 6 additional transmitters. Transmitters are not programmed. Each transmitter, including the two standard with the vehicle, must be programmed together by a dealer at customer expense. Transmitter programming is not a warranty item. See you owners manual supplement for programming information. (see also page 19 for customer programming of transmitters using the vehicles Driver Information Center procedure) Note: Vehicle specific, common fleet transmitter frequency not available
G80	LOCKING DIFFERENTIAL - Heavy-duty
6N6	LOCKS - Rear door inoperative (rear power locks are inoperable at rear door but operate from drivers position)
TRV	PROVISION FOR ROOF MOUNTED LAMP - Overhead console mounted switch and wiring to the roof; upfitter to install and connect a roof mounted warning lamp; instructions provided in owner's manual supplement
6B2	REAR DOOR HANDLES INOPERATIVE - Rear door locks inoperative (doors can be opened only from outside)
6N5	REAR WINDOW SWITCHES INOPERATIVE - Rear windows only operate from drivers position
AP3	REMOTE VEHICLE STARTER SYSTEM - Includes remote keyless entry
5T5	SEATS - Front cloth with vinyl rear seat (see page 4)
TGK	SPECIAL PAINT SOLID - One color all normally body-colored non-sheet metal parts will be gloss Black. This includes front and rear facias, liftgate handle and applique, D-pillars and upper liftgate applique. Mirrors and door handles will be grained Black parts. B85 body-side moldings are not available except with SEO option 5T4 exterior body-colored parts. May require extended lead time. Required with any SEO paint selection. May require extended lead time
7X6	SPOTLAMP - Left hand, separately fused
7X7	SPOTLAMPS - Left and right hand, separately fused
WX7	WIRING - For customer connection to front door and windshield pillar speakers. Speakers are not connected to the vehicle radio; radio audio signals are routed to the rear speakers
6J3	WIRING - For grille lamps and speaker. Front speakers are not connected to the vehicle radio,; radio audio is sent to the rear speakers
6J4	WIRING - For horn/siren circuit, in-line connection for customer furnished switch
	AUTONET MOBILE WIFI IN-CAR ROUTER - Available through your GM Dealer (see page 19 for Description)

For standard and optional illustrations see pages 17 through 19

8 | TAHOE 2WD POLICE PACKAGE PPV – SPECIFICATIONS

GENERAL

Model	CC10706
Drive	2-wheel

EXTERIOR (in./mm)

Wheelbase	116.0/2946
Overall length	202.0/5131
Overall width	79.0/2007
Overall height	73.9/1877
Lift in height (load floor to ground)	30.3/770
Step height - (front door sill to ground)	20.4/517
Step height - (rear door sill to ground)	20.8/528
Step height - (front running board to ground)	12.1/307
Step height - (rear running board to ground)	12.5/317
Front track width	68.2/1732
Rear track width	67.0/1701
Turning diameter curb to curb (ft./m)	39.0/11.9
Ground clearance (rear axle)	8.0/203

FRONT COMPARTMENT (in./mm)

Head room	41.1/1044
Shoulder room	65.2/1656
Hip room	60.3/1532
Leg room (maximum)	41.3/1049

REAR COMPARTMENT (in./mm)

Head room	39.2/996
Shoulder room	65.2/1656
Hip room	60.6/1539
Leg room (minimum)	39.0/991

CARGO

Load floor length to center of front seat at floor (in./mm)	81.4/2068
Load floor length to center of 2nd seat at floor (in./mm)	49.4/1255
Inside width between wheel house (in./mm)	49.1/1247
Cargo area height (in./mm)	41.7/1059
Cargo volume ³ maximum behind front seat (cu. ft./liters)	108.9/3084
Cargo volume ³ maximum behind second seat (cu. ft./liters)	60.3/1707

Note: For additional dimensional data go to: gmupfitter.com

PASSENGER COMPARTMENT VOLUME INDEX (cu.ft./liters)

Passenger compartment volume index ³	121.8/ 3449
---	-------------

FUEL ECONOMY RATINGS CITY/HIGHWAY/COMBINED

5.3L engine 2WD ⁴	15/21/17
------------------------------	----------

Projected EPA label values, actual mileage will vary with options, driving conditions, driving habits and vehicle's condition.

ALTERNATOR

Type	REMY DR44M
Amps	77°F (25°C) 160

TAHOE POLICE ALTERNATOR OUTPUT

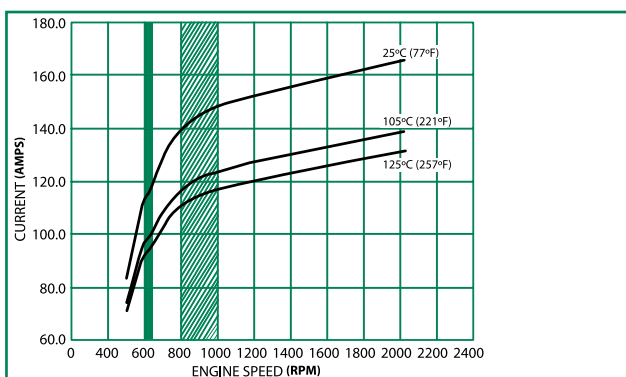

NORMAL IDLE SPEED: 600-650 RPMS

COMPUTER CONTROLLED IDLE SPEED RANGE (PARK): 800-1000 RPM

ENGINE

Type	STD Vortec V8
Displacement: liters/cu. in.	5.3/325
Horsepower/rpm	320 @ 5400
Torque lb.-ft./rpm	335 @ 4000
Induction system	SFI
Compression ratio	9.9:1
Exhaust	Single
Minimum recommended fuel octane	87
Fuel tank capacity (gallons/liters)	26/98
Oil with filter (quarts/liters)	6.0/5.7
Cooling capacity (quarts/liters)	18.3/17.3

TRANSMISSION

Automatic electronic with overdrive	6-speed
Fluid pan removed and filter replaced (quarts/liters)	6.0/5.7

AXLE

Ratio	3.08
-------	------

BRAKES

ABS with vacuum-boost	Disc/Disc
Front-swept area (sq. in./sq. cm)	256.6/1655
Rear-swept area (sq. in./sq. cm)	248/1600
Total front and rear swept area (sq. in./sq. cm)	504.6/3255
Front rotor diameter (in./mm)	13.0/330
Rear rotor diameter (in./mm)	13.5/343
Front rotor thickness (in./mm)	1.2/30
Rear rotor thickness (in./mm)	.79/20

TIRES

Type	Goodyear V-rated all-season
Size	P265/60R17

WHEELS

Type	Steel
Size	17" x 7.5"

CHASSIS

Frame	Full perimeter steel
Front suspension	Independent, single coil-over-shocks with stabilizer bar
Rear suspension	Multi-link with coil spring
Steering type	Power rack and pinion
Steering ratio	17.75:1

BATTERY

Type	Maintenance free
BCI group size	LN3
Volts	12
Amp hour rating	80
Cold cranking amps @ 0°F (-18°C)	730
Reserve capacity @ 80°F (27°C)	110

VEHICLE WEIGHT (lbs./kg.)

GVWR ⁵	6700/3039
Base Curb (vehicle without original manufactures optional equipment)	5342/2423
Payload with bucket seats ⁶	1358/616

Note: See owner's manual supplement for loading information

3. Cargo and load capacity limited by weight and distribution.
4. EPA-estimated MPG.
5. Gross Vehicle Weight Rating (GVWR). When properly equipped, includes vehicle, passengers, cargo and equipment.
6. Maximum payload capacity includes weight of driver, passengers, optional equipment and cargo.

UPDATES FOR 2012



NEW FEATURES

- (GAN) Silver Ice Metallic
- (89U) Crystal Red Tintcoat
- (16U) Graystone Metallic
- Electronic trailer sway control and hill start assist
- Autonet Mobile WiFi in-car router available (see page 19 for details)

DELETIONS

- (80U) Red Jewel Tintcoat
- (GGU) Steel Green Metallic
- (GGZ) Sheer Silver Metallic
- (GLF) Ice Blue Metallic
- (GGW) Taupe Gray Metallic

**Note: This vehicle is NOT designed nor intended for use IN HIGH SPEED EMERGENCY VEHICLE OPERATIONS
GM restricts the sale of police vehicles and they are not to be sold to retail customers.**

MODEL AVAILABILITY

CK10706 4-wheel drive

STANDARD EQUIPMENT SUMMARY

WARRANTY 3 years / 36,000 mile bumper-to-bumper (whichever comes first, see dealer for details)
5 years / 100,000 mile limited powertrain (whichever comes first, see dealer for details)

INTERIOR FEATURES

AIR CONDITIONING	Dual-zone manual climate control with individual climate settings for driver and front passenger; includes auxiliary rear air conditioning and heat (rear operated from front control only)
ASSIST HANDLES	Front passenger and second row outboard; front passenger assist handle is deleted when passenger side spotlamp is ordered
COMPASS	Standard
CONSOLE, OVERHEAD	Includes map lamps
CRUISE CONTROL	Electronic with set and resume speed
DOME LAMPS	Dome lamps, cargo lamp with sustained lamps feature and map lamps
FLOOR COVERING	Black vinyl floor and load floor behind second row
GLASS	Deep tinted (all windows except light-tinted glass on windshield, driver and front passenger side glass)
GLOVE BOX	Locking door, no light
MIRROR	Inside rearview manual day/night
ONSTAR	Not available on Special Service Package
OUTSIDE TEMP. DISPLAY	Standard
RADIO	AM/FM stereo with MP3 compatible CD player, seek-and-scan, digital clock, auto-tone control, Radio Data System (RDS), speed-compensated volume and theftlock
RESTRAINT SYSTEM	Tahoe received an overall 5-star frontal and side crash test rating from NHTSA¹². Safety belts, driver and front passenger with pretensioners, dual stage driver and passenger frontal air bags ¹ , passenger sensing system and frontal air bag ¹ ON/OFF indicator, rollover sensor, dual head curtain air bags ¹ for front and rear outboard occupants and front seat back mounted thorax-pelvic air bags ¹
SEAT, FRONT	Cloth 40/20/40 split-bench 3-passenger, includes 6-way power driver seat adjuster (power passenger seat is not available) with manual lumbar, driver and passenger manual reclining, outboard head restraints, center fold-down storage armrest and rear storage pockets (see page 12). Bucket seats available, see page 14
SEAT, REAR	Vinyl split-folding 60/40 bench with outboard seating position headrests, 3rd seat not available (see page 12)
SPEEDOMETER/CLUSTER	120 mph analog speedometer and digital trip odometer with gages for engine oil pressure, fuel, battery volts and coolant temperature. Driver Information Center displays engine hours, warnings and other information (see message listing on page 16)
STEALTH MODE	See exterior lamps control on page 18 for operation description
STEERING WHEEL	Tilt-wheel with column mounted gear shift lever
THEFT DETERRENT SYSTEM	Vehicle PASS-Key [®] III+ and content theft (unauthorized entry sounds horn and lamps flash). For content theft alarm disable option UTQ must be ordered (see page 14)
VISORS	Padded with cloth trim, extends on rod; driver and front passenger illuminated vanity mirrors
WARNING TONES	Headlamp on, key-in-ignition, driver and right-front passenger safety belt unfasten and turn signal on
WINDOW OPERATION	Power with driver express-down and lockout features

ELECTRICAL FEATURES

AUXILIARY POWER, FRONT	100-amp ignition and main power supply wiring at lower center of instrument panel (see wiring provisions for 12-volt battery power supply on page 25)
AUXILIARY POWER, REAR	100-amp auxiliary power in cargo area (see page 27)
GROUND STUDS	Two studs located in rear compartment near bottom of liftgate opening (see page 27)
LOCK-OUT PROTECTION	Prevents the power door locks from locking the driver's door if the keys are left in the ignition (manually lockable with engine running)
POWER OUTLETS	Two located on instrument panel and one in rear cargo area
WIRING DIAGRAMS	See pages 25 through 32 for description; also see Tahoe Police Package owner's manual supplement (located in glove box folder with standard owner's manual)
WIRING PROVISION, EXTERIOR LAMPS FLASHING	Forward lamp harness in-line connector for Exterior Lamps Flashing System (see option 6J7 on page 14)

- Head curtain side air bags are designed to help reduce the risk of head and neck injuries to front and rear seat occupants on the near side of certain side-impact collisions. Always use safety belts and the correct child restraints for your child's age and size, even in vehicles equipped with air bags. Children are safer when properly secured in a rear seat. See your vehicle Owner's Manual and child safety seat instructions for more information.
- Model tested with standard head curtain side-impact air bags (SABs). Government 5-Star Safety ratings are part of the National Highway Traffic Safety Administration's (NHTSA's) New Car Assessment Program (www.SaferCar.gov).

EXTERIOR FEATURES

ASSIST STEPS	Black, mounted between front and rear wheels
DEFOGGER	Electric, rear window
DOOR HANDLES	Matte Black
DOOR LOCKS	Power, non-programmable with lockout protection, and automatic door locking and unlocking, door lock cylinder no longer available on passenger front door and rear liftgate; child safety locks included in rear doors
FASCIA, FRONT	Color - keyed
FASCIA, REAR	Color - keyed with step pad
FOG LAMPS	Not available
HEADLAMPS	Dual halogen composite with flash-to-pass feature, automatic exterior lamp control and daytime running lamps (to delete automatic lamp control, see option 9G8 on pages 14 and 18)
HORNS	Dual tone
KEYLESS ENTRY	Includes two transmitters with non-functional panic button; stealth mode feature includes exterior lamps and horn disable; if remote start Option AP3 is included running lamps will remain illuminated (additional transmitters are available; see option AMF on page 14)
KEYS	Two-sided random code, for ignition and drivers door only
LUGGAGE RACK	Not available
MIRRORS	Outside heated power-adjustable, manual-folding, Matte Black
REAR LIFTGATE	Liftgate/liftglass with washer and wiper, power liftgate not available and no lock cylinder on liftgate
RECOVERY HOOKS	Two front
UNDER HOOD LAMP	Not available
WINDSHIELD WIPERS	Intermittent with washer

CHASSIS FEATURES

AIR CLEANER	High-capacity
ALTERNATOR	160-amp with idle boost (transmission in PARK or NEUTRAL) based on battery energy level
BATTERY	Heavy-duty 730 cca with battery rundown protection (does not protect customer installed equipment)
BRAKES	4-wheel anti-lock front and rear disc with vacuum boost power assist
COOLING	Heavy-duty high capacity radiator, electric fans and extended life coolant; coolant hoses are EPDM (ethylene-propylene-diene monomer) rubber; silicone hoses are not required (coolant is DEX-COOL good for 5 years/150,000 miles, protects from -34° F to +265° F and against rust and corrosion)
ENGINE	Vortec 5300 V8 SFI with variable valve timing (VVT) active fuel management, FlexFuel ² (capable of running on gasoline or E85 ethanol; mixtures) top speed fuel cutoff at 98 MPH
FRAME	Full perimeter modular with hydroformed frame rails
FUEL TANK CAPACITY	26 gallon (98 liters)
OIL COOLERS	Engine and transmission auxiliary air-to-oil and power steering (see page 17 for description)
RADIO SUPPRESSION	Grounding straps at five additional locations (see page 18 for location)
SPARK PLUGS	Extended life - iridium tip
STABILITRAK	Stability enhancement system. An advanced computer controlled system that assists the driver with directional control of the vehicle in difficult driving conditions. Each time the vehicle is started, the StabiliTrak system is fully on. StabiliTrak can be controlled by a StabiliTrak button on the instrument panel. The condition of the system is displayed by an instrument panel StabiliTrak indicator light and Driver Information Center (DIC) Messages. Push once, Traction Control is off, push and hold five seconds Traction Control and StabiliTrak is off, push again and Traction Control and StabiliTrak are turned back on
STEERING	Power, rack and pinion
SUSPENSION, FRONT	Coil-over-shock with stabilizer bar
SUSPENSION, REAR	Multi-link with coil springs with stabilizer bar
TIRES	P265/70R17 all-season SBR
TIRE PRESSURE MONITOR	CHECK TIRE PRESSURE (no spare tire sensor)
TIRE, SPARE	Full-size spare, lockable with outside winch-type carrier mounted under frame at rear (TPM sensor not included)
TRAILERING EQUIPMENT	Heavy-duty, includes trailering hitch platform, 7-wire harness with independent fused trailering circuits mated to a 7-way sealed connector, VR4 2-inch trailering receiver and electric brake controller jumper harness
TRANSFER CASE	Electronic autotrac
TRANSMISSION	6-speed automatic with overdrive and tow/haul mode, electronically-controlled transmission provides protection against over-revving the engine in low gear and a mechanical low gear blackout is not required; if a driver manually selects low gear and fails to manually upshift to high gear, the powertrain control module automatically protects the drivetrain
WHEELS	17" x 7.5" argent steel
WHEEL CENTER CAP	Argent, retained to wheel lugnuts

2. E85 is 85% ethanol and 15% gasoline. To see if there is an E85 station near you, go to www.gmaltfuel.com/e85-station-locator.

POWERTRAIN							
ENGINE				TRANSMISSION		AXLE	
OPTION CODE	TYPE	DISPLACEMENT LITERS/CU. IN.	FUEL SYSTEM	OPTION CODE	TYPE	OPTION CODE	RATIO
LMG	V8	5.3/325	Active fuel management FlexFuel ² (gas or E85 ethanol)	MXO/MYC	6L80 6-speed auto. with OD	GU6	3.42

EMISSIONS - MUST BE SPECIFIED	
FE9	FEDERAL EMISSIONS. Use for ordering vehicles that will be registered in all states except California, Connecticut, Maine, Maryland, Massachusetts, New Jersey, New Mexico, New York, Oregon, Pennsylvania, Rhode Island, Vermont and Washington State
YF5	CALIFORNIA EMISSIONS. Use for ordering vehicles that will be registered in California.
NE1	CT/ME/MD/MA/NJ/NM/NY/OR/PA/RI/VT/WA EMISSIONS. Use for ordering vehicles that will be registered in Connecticut, Maine, Maryland, Massachusetts, New Jersey, New Mexico, New York, Oregon, Pennsylvania, Rhode Island, Vermont or Washington State
NB8	Required when option code FE9 "FEDERAL EMISSIONS" is ordered for delivery to a dealer located in California, Connecticut, Massachusetts, Maryland, New Jersey, New Mexico, New York, Oregon, Pennsylvania, Rhode Island and Washington State for a purchaser who will be registering the vehicle outside California, Connecticut, Maine, Maryland, Massachusetts, New Jersey, New Mexico, New York, Oregon, Pennsylvania, Rhode Island, Vermont and Washington State.
NC7	Required when option code YF5 "CALIFORNIA EMISSIONS" or option code NE1 "CT/ME/MD/MA/NJ/NM/NY/OR/PA/RI/VT/WA EMISSIONS" is ordered for delivery to a dealer located in any state except California, Connecticut, Maine, Maryland, Massachusetts, New Jersey, New Mexico, New York, Oregon, Pennsylvania, Rhode Island, Vermont and Washington for a purchaser who will be registering the vehicle in one of these states or sold as permitted below under "EPA Policy on the Sale of California Emission Vehicles"
NB9	Required when option code YF5 is ordered for delivery to a dealer located in Connecticut, Maine, Maryland, Massachusetts, New Jersey, New Mexico, New York, Oregon, Pennsylvania, Rhode Island, Vermont and Washington. Required when option code NE1 is ordered for delivery to a dealer located in California.

TIRES - SPEED RATED				
MANUFACTURER	QUANTITY	SIZE	SPEED RATING	TYPE
Random	5	P265/70R17	S	All season BW

Note: Optional on/off-road tire is available (see page 14)

SEATS AND INTERIOR TRIM		
	SEAT OPTIONS	EBONY
STANDARD Front: cloth 40/20/40 split-bench (power driver side seat only) Rear: vinyl 60/40 split-bench	AZ3 5T5	19C
OPTIONAL Front: cloth buckets with center console (power driver and passenger seat) Rear: vinyl 60/40 split-bench	A95 5T5	19C
OPTIONAL Front: cloth buckets without center console (power driver and passenger seat) Rear: vinyl 60/40 split-bench	A95 and 9N5 5T5	19C









2. E85 is 85% ethanol and 15% gasoline. To see if there is an E85 station near you, go to www.gmaltfuel.com/e85-station-locator.

AVAILABLE EXTERIOR COLORS

							
16U	GHA	89U	GAN	41U	50U	51U	58U
Graystone Metallic (New)	Mocha Steel Metallic	Crystal Red* Tintcoat (New)	Silver Ice Metallic (New)	Black	Summit White	Gold Mist Metallic	Black Granite* Metallic

*Actual colors may vary * Additional Charge*

SEO PAINT AVAILABLE

WA#	COLOR DESCRIPTION		CODE
253A	Wheatland Yellow		9W3
334D	Dark Toreador Red		
722J	Dark Blue Metallic		9V7
5665	Blue		9V2
7941	Green		
9015	Woodland Green		9V5
9260	Victory Red		5T4
9414	Yellow		

ACTUAL COLOR MAY VARY

- Note:**
- All normally body-colored non-sheet metal parts, will be Flat Black (except Victory Red non-sheet metal parts will match)
 - SEO paint orders that contain less than five vehicles will be delayed until five unit minimum is received for batch production

UNITED STATES SPEEDOMETER/CLUSTER (CANADIAN SIMILAR)

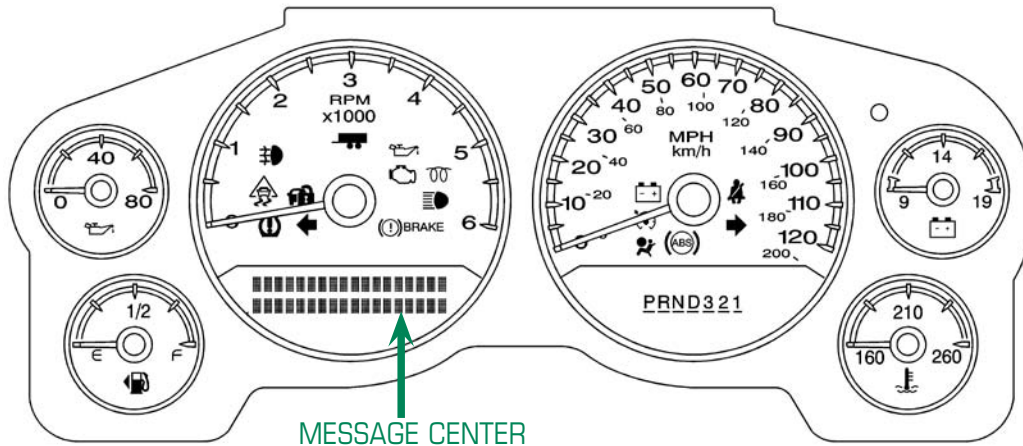

CHANGE ENGINE OIL SOON	SERVICE AIR BAG
CHECK TIRE PRESSURE (PRESS RESET) LF/RF/LR/RR	SERVICE BATTERY CHARGING SYSTEM
DRIVER DOOR OPEN	ENGINE HOURS
ENGINE HOT A/C TURNED OFF	SERVICE BRAKE SYSTEM
ENGINE OIL LOW ADD OIL	SERVICE BRAKES SOON
ENGINE OVERHEATED IDLE ENGINE	SERVICE THEFT DETERRENT SYSTEM
ENGINE OVERHEATED STOP ENGINE	SERVICE TIRE MONITOR SYSTEM
ENGINE POWER IS REDUCED	SERVICE TRACTION CONTROL
FUEL LEVEL LOW	SERVICE STABILITRAK
HOOD OPEN	STABILITRAK OFF
LEFT REAR DOOR OPEN	SERVICE 4-WHEEL DRIVE
OIL PRESSURE LOW STOP ENGINE	TIGHTEN GAS CAP
PASSENGER DOOR OPEN	TIRE LEARNING ACTIVE
REAR ACCESS OPEN	TRACTION CONTROL OFF
REMOTE KEY LEARNING ACTIVE	TRANSMISSION HOT IDLE ENGINE
REPLACE BATTERY IN REMOTE KEY	TURN SIGNAL ON
RIGHT REAR DOOR OPEN	WASHER FLUID LOW ADD FLUID

Note: The Tahoe Police Package and Special Service Package are not equipped with DIC buttons. The instrument cluster odometer trip stem is used to display the following messages: odometer, engine hours, trip odometer, tire pressure, remote keyless entry, relearn remote key, programming and DIC language.
See the Tahoe owner's manual for operation description.

AVAILABLE OPTIONS WITH TAHOE 5W4 SPECIAL SERVICE PACKAGE

6A6	BATTERIES, DUAL HEAVY-DUTY 730 CCA - Parallel connected
B85	BODY SIDE MOLDINGS - On 4 doors
JL1	BRAKE CONTROLLER - Integrated trailer
9G3	CHASSIS PACKAGE OFF-ROAD SUSPENSION - (Requires QJP tire and includes NZZ skid plates, K47 high capacity air cleaner, no Z71 decal)
9N5	CONSOLE DELETE - Between seats (Requires A95)
UTQ	CONTENT THEFT ALARM DISABLE - Flashing lamps and horn warning
9G8	DELETE DAYTIME RUNNING LAMPS AND AUTOMATIC HEADLAMPS
9V7	EXTERIOR BODY COLORED PARTS - Dark Blue Metallic, provides Dark Blue Metallic special paint WA722J and Dark Blue Metallic special painted exterior body parts in lieu of glossy Black color normally installed with special paint. Dark Blue Metallic painted parts will consist of front fascia, rear bumper fascia, rear liftgate handle and liftgate applique above license plate. Door handles, mirrors, rear D-pillar applique and liftgate spoiler will remain Black. B85 body-side moldings are not available. Requires SEO TKG special paint
5T4	EXTERIOR BODY COLORED PARTS - Victory Red special painted exterior body parts in lieu of glossy Black color normally installed with special painted bodies, Victory Red painted parts will consist of front fascia, rear bumper fascia, rear liftgate license plate applique and rear liftgate handle, door handles and body side moldings. Mirrors, rear D-pillar applique and liftgate spoiler will remain Black. Requires SEO TKG special paint and special paint color WA9260 Victory Red. Includes RPO B85 body side moldings
6J7	FLASHER SYSTEM HEADLAMP AND TAIL LAMP - DRL compatible, headlamp flasher module with control wire and body control module rear lamp flashing
B30	FLOOR COVERING - Color keyed carpeting front and 2nd row (not available with vinyl floor covering)
B58	FLOOR MATS - Color keyed carpeting
K05	HEATER - Engine block
5W4	IDENTIFIER - Special Service Package
6E2	KEY COMMON - Complete vehicle fleet, provides a single key with a specific code that is common to the door lock and ignition of all the vehicles in the vehicle fleet; key code is an alternate to SEO 6E8 key common, complete vehicle fleet; not compatible with 2005 and earlier Impalas, 2006 and earlier Tahoes and 2011 Caprice
6E8	KEY COMMON - Complete vehicle fleet, provides a single key with a specific code that is common to the door lock and ignition of all the vehicles in the vehicle fleet; key code is an alternate to SEO 6E2 key common, complete vehicle fleet; not compatible with 2005 and earlier Impalas and 2006 and earlier Tahoes and 2011 Caprice
AMF	KEYLESS ENTRY TRANSMITTERS - Fleet Package includes 6 additional transmitters. Transmitters are not programmed. Each transmitter, including the two standard with the vehicle, must be programmed together by a dealer at customer expense. Transmitter programming is not a warranty item. See you owners manual supplement for programming information. (see also page 19 for customer programming of transmitters using the vehicles Driver Information Center procedure) Note: Vehicle specific, common fleet transmitter frequency not available
G80	LOCKING DIFFERENTIAL
6N6	LOCKS - Rear door inoperative (Rear power locks are inoperable at rear doors but operate from drivers position)
TRW	PROVISION FOR ROOF MOUNTED LAMP - Overhead console mounted switch and wiring to the roof; upfitter to install and connect a roof mounted warning lamp; instructions provided in owner's manual supplement
6B2	REAR DOOR HANDLES INOPERATIVE - Rear door locks inoperative (doors can be opened only from outside)
6N5	REAR WINDOW SWITCHES INOPERATIVE - Rear window only operates from driver's position
AP3	REMOTE VEHICLE STARTER SYSTEM - Includes remote keyless entry
AZ3	SEATS - Front custom cloth 40/20/40 split-bench, power driver seat only (see page 12)
A95	SEATS - Front bucket with custom cloth, 6-way power with center console, to delete center floor console 9N5 must be ordered (see page 12)
5T5	SEATS - Front cloth with vinyl rear seat (see page 12)
NZZ	SKID PLATES PACKAGE
TGK	SPECIAL PAINT SOLID - One color all normally body-colored non-sheet metal parts will be gloss Black. This includes front and rear facias, liftgate handle and applique, D-pillars and upper liftgate applique. Mirrors and door handles will be grained Black parts. B85 body-side moldings are not available except with SEO option 5T4 exterior body-colored parts. May require extended lead time. Required with any SEO paint selection. May require extended lead time
7X6	SPOTLAMP - Left hand, separately fused
7X7	SPOTLAMP - Left and right hand, separately fused
9G3	SUSPENSION PACKAGE - Off-road
4JP	TIRE SPARE - P265-70R17 on/off-road, blackwall (requires QJP tires)
QJP	TIRES - P265-70R17 on/off-road (for full-size spare tire 4JP must be ordered)
P46	WHEELS - Aluminum
WX7	WIRING - For customer connection to front door and windshield pillar speakers. Speakers are not connected to the vehicle radio; radio audio signals are routed to the rear speakers
6J3	WIRING - For grille lamps and speaker
6J4	WIRING - For horn/siren circuit, in-line connection for customer furnished switch
	AUTONET MOBILE WIFI IN-CAR ROUTER - Available through your GM Dealer (see page 19 for Description)

For standard and optional illustrations see pages 17 though 19 in PPV section

16 | TAHOE 4WD SPECIAL SERVICE 5W4 – SPECIFICATIONS

GENERAL

Model	CK10706
Drive	4-wheel
EXTERIOR (in./mm)	
Wheelbase	116.0/2946
Overall length	202.0/5131
Overall width	79.0/2007
Overall height	76.9/1953
Lift in height (load floor to ground)	32.6/828
Step height - (front door sill to ground)	22.3/567
Step height - (rear door sill to ground)	22.8/580
Step height - (front running board to ground)	14.0/356
Step height - (rear running board to ground)	14.5/369
Front track width	68.2/1732
Rear track width	67.0/1701
Turning diameter curb to curb (ft./m)	39.0/11.9
Ground clearance	9.1/231

FRONT COMPARTMENT (in./mm)

Head room	41.1/1044
Shoulder room	65.2/1656
Hip room	60.3/1532
Leg room (maximum)	41.3/1049

REAR COMPARTMENT (in./mm)

Head room	39.2/996
Shoulder room	65.2/1656
Hip room	60.6/1539
Leg room (minimum)	39.0/991

CARGO

Load floor length to center front seat at floor (in./mm)	81.4/2068
Load floor length to center 2nd seat at floor (in./mm)	49.4/1255
Inside width between wheel house (in./mm)	49.1/1247
Cargo area height (in./mm)	41.7/1059
Cargo volume ³ maximum behind front seat (cu. ft./liters)	108.9/3084
Cargo volume ³ maximum behind second seat (cu. ft./liters)	60.3/1707

Note: For additional dimensional data go to: gmupfitter.com

PASSENGER COMPARTMENT VOLUME INDEX (cu.ft./liters)

Passenger compartment volume index ³	121.8/ 3449
---	-------------

FUEL ECONOMY RATINGS CITY/HIGHWAY/COMBINED

5.3L engine 4WD ⁴	15/21/17
------------------------------	----------

Projected EPA label values, actual mileage will vary with options, driving conditions, driving habits and vehicles condition.

ALTERNATOR

Type	REMY DR44M
Amps	77°F (25°C) 160

TAHOE POLICE ALTERNATOR OUTPUT

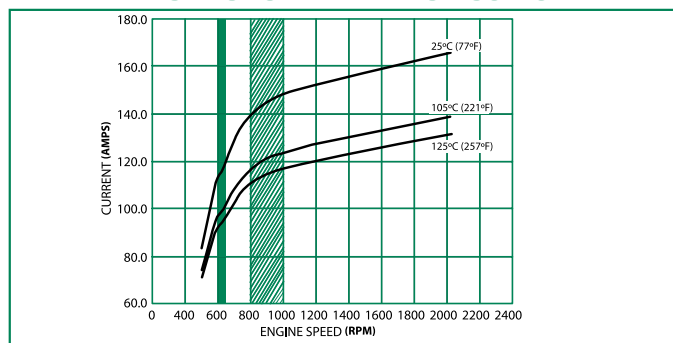

NORMAL IDLE SPEED: 600-650 RPMs

COMPUTER CONTROLLED IDLE SPEED RANGE (PARK): 800-1000 RPM

- Cargo and load capacity limited by weight and distribution.
- EPA-estimated MPG.
- Gross Vehicle Weight Rating (GVWR). When properly equipped, includes vehicle, passengers, cargo and equipment.

ENGINE

Type	Vortec V8
Displacement: liters/cu. in.	5.3/325
Horsepower/rpm	320 @ 5400
Torque lb.-ft./rpm	335 @ 4000
Induction system	SFI
Compression ratio	9.9:1
Exhaust	Single
Minimum recommended fuel octane	87
Fuel tank capacity (gallons/liters)	26/98
Oil with filter (quarts/liters)	6.0/5.7
Cooling capacity (quarts/liters)	18.3/17.3

TRANSMISSION

Automatic electronic with overdrive	6-speed
Fluid pan removed and filter replaced (quarts/liters)	6.0/5.7

AXLE

Ratio 4-wheel drive	3.42
---------------------	------

BRAKES

ABS with vacuum boost	Disc/Disc
Front - swept area (sq. in./sq. cm)	256.6/1655
Rear - swept area (sq. in./sq. cm)	248/1600
Total front and rear swept area (sq. in./sq. cm)	504.6/3255
Front rotor diameter (in./mm)	13.0/330
Rear rotor diameter (in./mm)	13.5/343
Front rotor thickness (in./mm)	1.2/30
Rear rotor thickness (in./mm)	.79/20

TIRES

Type	All-season
Size	P265/70R17

WHEELS

Type	Steel
Size	17" x 7.5"

CHASSIS

Frame	Full perimeter steel
Front suspension	Independent, single coil-over-shock with stabilizer bar
Rear suspension	Multi-link with coil spring
Steering type	Power rack and pinion
Steering ratio	17.75:1

BATTERY

Type	Maintenance free
BCI group size	LN3
Volts	12
Amp hour rating	80
Cold cranking amps @ 0°F (-18°C)	730
Reserve capacity @ 80°F (27°C)	110

VEHICLE WEIGHT (lbs./kg.)

GVWR ⁵ 4-wheel drive	7300/3311
Base Curb (vehicle without original manufactures optional equipment)	5627/2552
Payload ⁶ with 40/20/40 split-bench seat	1673/759
GCWR (gross combination weight ratings)	14000/6350
Maximum trailer weight ⁷	8200/3720

Note: See owner's manual supplement for loading information

- Maximum payload capacity includes weight of driver, passengers, optional equipment and cargo.
- Maximum trailer weight ratings are calculated assuming a base vehicle, except for any option(s) necessary to achieve the rating, plus driver. The weight of other optional equipment, passengers and cargo will reduce the maximum trailer weight your vehicle can tow.

ENGINE OIL COOLER

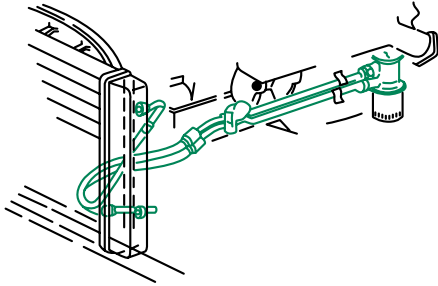

Engine oil cooler located in the left hand radiator tank. Cooler consists of an inlet and an outlet pipe attached to the engine oil filter adapter which transmits the oil to the cooler and then back to the engine. The cooler itself consists of numerous flat plates through which the hot oil flows, transmitting heat to the coolant and cooling the oil.

TRANSMISSION OIL COOLER

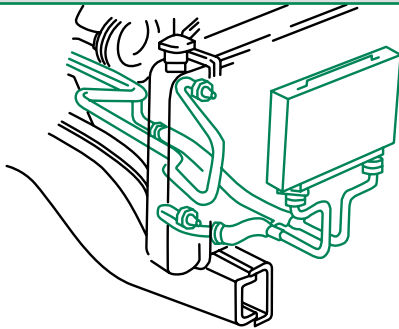

External air-to-oil cooler is mounted in front of coolant radiator and A/C condenser at the center and is connected in series with the integral transmission oil cooler in the right end tank of the coolant radiator.

RADIO SUPPRESSION GROUND STRAPS

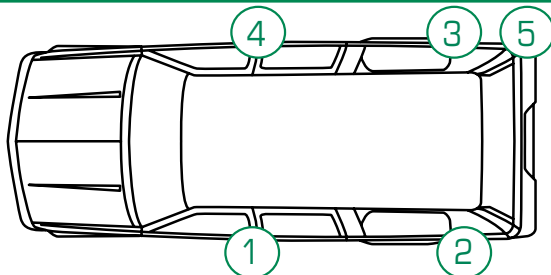

Police Package is equipped with additional grounding in the following locations:

1. Left hand front frame body mount bracket to underbody
2. Left hand rear frame body mount bracket to rear underbody
3. Right hand rear frame body mount bracket to rear underbody
4. Right hand center frame body mount bracket to center underbody
5. Exhaust pipe hanger rod to rear frame hanger

COVERING - FLOOR

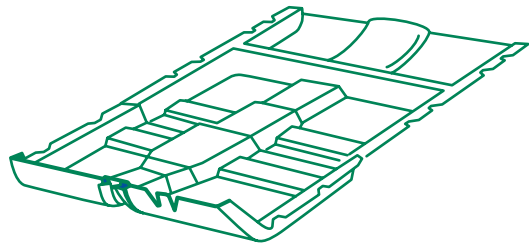

Black heavy-duty one piece. Replaces production carpeting.

POWER STEERING COOLER

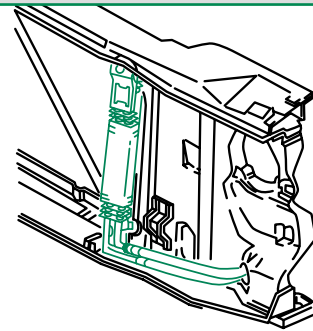

Vertical finned cooler is mounted in front of the radiator at the left side of the radiator and connected in-line between the power steering pump and steering gear.

TIRE PRESSURE MONITOR

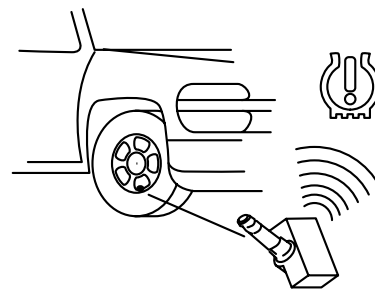

Your vehicle is equipped with a Tire Pressure Monitor (TPM) System which warns of low tire pressure. The TPM System on your Tahoe Police Package has a spare tire sensor but is not programmed to read the spare tire pressure. When the spare tire from your vehicle or an unused spare tire from another Police Package is placed in use as a road wheel, the system will not read the presence of the new TPM sensor and must be calibrated. Refer to your owner's manual for additional information on the Tire Pressure Monitor and Sensor Programming. The Special Service Package 5W4 does not have sensor in spare tire.

INTERIOR/EXTERIOR LAMPS CONTROL

(PPV ONLY)

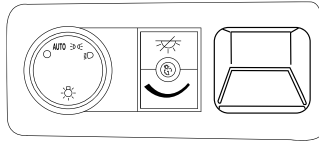

(5W4 ONLY)

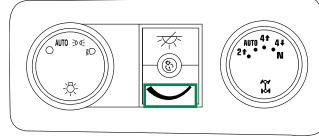

9G8 - Delete Daytime Running Lamps and Automatic Headlamps. This option disables the Daytime Running Lamps and Automatic Headlamps control feature. Exterior lamps are manually controlled only. Option 9G8 not available in Canada.

Courtesy lamps, including dome lamps, can be turned off with a push button switch which is above the interior lamp intensity control knob. When the switch is activated, courtesy lamps remain off when any vehicle door is open. If a door is open when the switch is activated, the lamps will go off.

The instrument cluster and radio lighting dimmer control will override the push button switch to turn on the courtesy lamps.

The headlamp control on the driver's side of the instrument panel operates the headlamps. If your Tahoe does not have option 9G8, Delete Daytime Running Lamps and Automatic Headlamps, the Daytime Running Lamps and Automatic Headlamps can be turned off for one ignition cycle by rotating the control knob momentarily counter-clockwise. See also section 3 of your Tahoe owner's manual.

In Canada, the Daytime Running Lamps and Automatic Headlamps can be turned off if the transmission is in Park. See also your Tahoe owner's manual.

SERVICE PARTS IDENTIFICATION LABEL

SERVICE PARTS IDENTIFICATION

DO NOT REMOVE

1GNLC2E0BR8152140										PDBJCH	CC10706
AGK	AG2	AL0	AMF	AP3	AR9	AT8	AXJ	AY0	A75	A76	
BDR	B3B	B42	B86	B9V	C67	DK2	EF7	E2C	FE9	FR9	
IPG	JA9	JL9	KD1	KG4	LGD	MX0	M15	NK5	NT7	N99	
OST	QPP	R7V	R9N	R9Z	SLM	T53	UH8	UJM	UN9	UT7	
UW6	UIC	U77	VT7	V8D	WL9	ZFH	1SZ	19C	41U	191	
3FL	6A3	6E2	6HP	6J1	6J3	6J4	6J7	7B3	7HP	7M9	
7X6	8MZ	PPV	9MZ								
BC/CC			U 636R								

A Service Parts Identification (SPID) Label provides Vehicle Identification Number (VIN)-specific Option Code content list, Engineering Model Number (Nameplate, body style), Exterior paint system, Exterior paint color code and Interior trim level and color. The SPID label for the Tahoe is located on the inner surface of the instrument panel storage compartment (glove box).

TAHOE PPV AND 5W4 SPECIAL EQUIPMENT - OPTIONAL | 18

AUTONET MOBILE WIFI; IN-CAR ROUTER



Delivers high speed network connectivity to vehicles by leveraging the 3G network. Autonet Mobile's TRU Technology, a proprietary and patented technology, provides a seamless connection regardless how fast you are traveling. Unlike conventional cellular data technology, TRU Technology manages data as users travel at high speeds between cell towers, eliminating dropped connections. CarFi™ provides wireless device connectivity within the vehicle using standards-based 802.11 Wi-Fi networking. This allows users in and around the vehicle to access the Internet using any Wi-Fi enabled device. Available through your GM dealer.

7X6 AND 7X7 – SPOTLAMPS

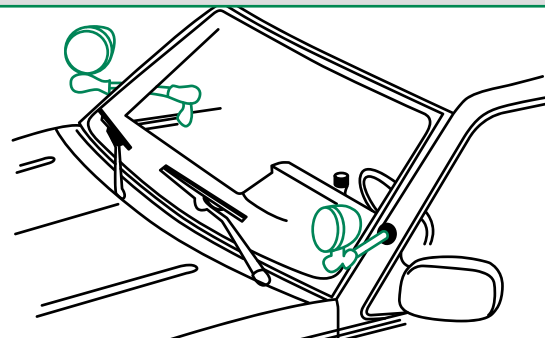

7X6 Spotlamp left hand, pillar-mounted unity, 6-inch with replaceable H3 halogen bulb; independently fused

7X7 Spotlamps left and right hand, pillar-mounted unity, 6-inch with replaceable H3 halogen bulb; independently fused

Note: Customer furnished spotlamp assembly should be installed to avoid contact with a deploying air bag

AMF - PACKAGE OF 6 TRANSMITTERS

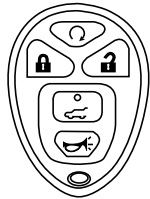

WITH REMOTE START AND LIFTGLASS (WITHOUT REMOTE SIMILAR)



WITH REMOTE START AND POWER LIFTGATE AND LIFTGLASS (WITHOUT REMOTE START SIMILAR)

RELEARN REMOTE KEY

To access this DIC display, the vehicle must be in PARK. This display allows you to match the remote keyless entry transmitter to your vehicle. To match a remote keyless entry transmitter to your vehicle, do the following:

1. Press the trip odometer reset stem until PRESS THE RELEARN REMOTE KEY displays.
2. Press and hold the trip reset stem for 3 seconds. The message REMOTE KEY LEARNING ACTIVE will display.
3. Press and hold the LOCK and UNLOCK buttons on the first transmitter at the same time for approximately 15 seconds. A beep will sound indicating that the transmitter is matched.
4. To match additional transmitters at this time, repeat Step 3. Each vehicle can have a maximum of eight transmitters matched to it.
5. To exit the program mode, turn the key to the LOCK position.

NOTE: A maximum of 8 keys may be learned for a vehicle immobilizer (Passkey III+) with a random key code. Vehicles with the fleet key option (RPO 6E2 or 6E8) may have more than 8 keys learned for the particular option fleet key and must be learned using one of the original "master" keys. When programming RPO AMF additional 6 remotes transmitters, the original 2 transmitter delivered with a vehicle must also be reprogrammed at the same time.

WIRING PROVISION FOR FRONT SPEAKERS – OPTION WX7

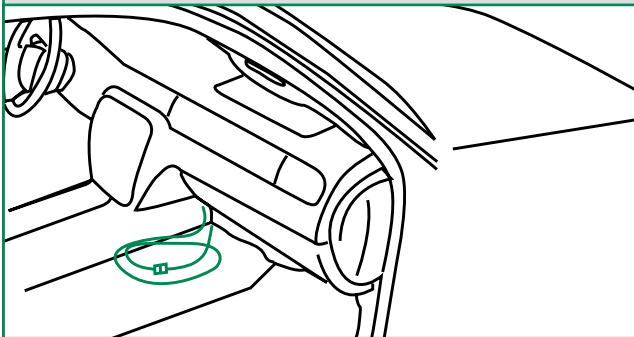

Approximately 60 inches (1.5 m) of auxiliary speaker wiring is routed from the front door and windshield pillar speakers and coiled under the instrument panel. The wiring permits connection of the front speaker pairs to customer-installed communication equipment. Vehicle radio front speaker outputs are re-routed to the rear speakers to maintain the required open door/key-in-ignition audible warning.

6B2 HANDLES – REAR DOOR INOPERATIVE

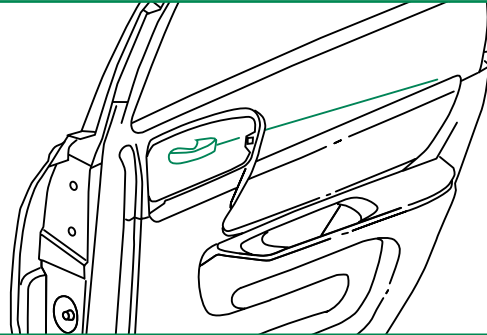

Inside rear door handles are disconnected. Rear doors can only be opened from the outside.

6N5 SWITCHES – REAR WINDOW INOPERATIVE

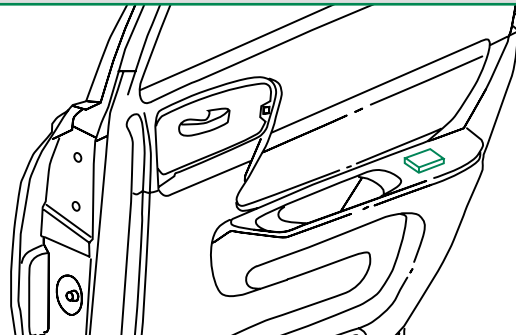

Rear door window switches are inoperative. Rear door power regulators are operable only from driver position switches.

6N6 LOCKS – REAR DOOR INOPERATIVE

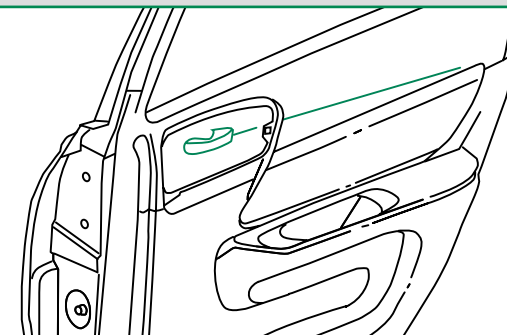

Rear door locking rods are disabled. Rear door locks are inoperative at rear doors, but operate from driver position.

Can specialty vehicle equipment (e.g. radar devices, video cameras, computers, meters, radio trees, shotguns, etc.) still be mounted in cars with passenger side air bags?

Yes, but care must be taken to mount the equipment outside of the deployment zone. Air bags inflate with great force and will interact with any object in the deployment zone. Therefore, to reduce the risk of injury to vehicle occupants, GM recommends that the air deployment zone be kept free of any equipment. If a piece of equipment were to become dislodged it could strike an occupant in the vehicle and result in injury. The likelihood of an object becoming dislodged is influenced by many factors, including the proximity of the object to the inflatable restraint, the size and shape of the object, and the means by which the object is secured to the vehicle. In addition to these factors, the trajectory and velocity of a dislodged object can be influenced by the type and severity of vehicle crash.

Objects that are in the deployment zone, but do not become dislodged by an inflating air bag can still affect the performance of the air bag. For example, such objects could tear the fabric or affect the shape of the air bag, thus reducing the ability of the bag to provide restraint.

Is it possible to shield equipment that is installed in the passenger side frontal air bag deployment zone in a manner that will allow full and safe air bag deployment?

Due to the complexity of influencing variables, GM is unable to evaluate the potential for shielding expected equipment configurations in all accident scenarios in order to assure that the air bag performance would be unaffected. While shielding may protect certain equipment from being damaged or dislodged, it may also negatively affect the inflation characteristics of the air bag. The air bag's shape, inflation angle, fold pattern, and inflation rate and pressure are developed to maximize the protection capability of the inflatable restraint system. Therefore, GM cannot recommend the placement of any equipment in the deployment zone, even if it is shielded to protect it from damage.

Front air bag systems and instrument panel mounted equipment.

Passenger air bags in GM vehicles deploy in different ways depending upon the type of vehicle and the particular instrument panel design.

In some vehicles, the passenger air bag deploys through a discrete door located on the top surface of the instrument panel (top-mount air bag systems). In other vehicles, such as the Chevrolet Tahoe, the passenger air bag deploys through a discrete door mounted on the vertical rearward surface of the instrument panel, above the glove box door (mid-mount air bag system). With these types of top-mount and mid-mount passenger air bag systems, the top pad of the instrument panel remains in place during deployment.

Some GM passenger air bag systems, like the system in the Chevrolet Impala, deploy from beneath the instrument panel top pad. These are considered 3/4-mount air bag systems with a "deployable top pad." The entire instrument panel top pad is the "deployment door" from under which the inflating air bag emerges. When an air bag deployment is commanded, the forces from the inflating passenger air bag push up on the instrument panel top pad, releasing special fasteners across the rearward edge of the top pad. This allows the top pad to rotate upward so that the passenger air bag may emerge. The top pad rotates upward to open widest at the right hand side, and is usually forced upward into contact with the windshield on the right hand side of the vehicle during a deployment.

Head curtain side air bags are designed to help reduce the risk of head and neck injuries to front and rear seat occupants on the near side of certain side-impact collisions. Always use safety belts and the correct child restraints for your child's age and size, even in vehicles equipped with air bags. Children are safer when properly secured in a rear seat. See your vehicle Owner's Manual and child safety seat instructions for more information.

Instrument panel top mounted special equipment, such as a radar antenna and control unit or video camera must be positioned to the left of the vehicle center line. This equipment must be mounted as low as possible and securely fastened to the top pad to avoid being dislodged in the event of a crash and possible air bag deployment. In the process of securely fastening special equipment to the top, DO NOT fasten down the top pad itself to any other vehicle component such as the cluster trim plate. As described above, the top pad rotates upward during a deployment. In order to enable the proper deployment of the passenger air bag, specialty equipment installation MUST NOT PREVENT the top pad from rotating upward during deployment. Location and attachment of special equipment should minimize added resistance or interference to upward rotation of the top pad during deployment.

Optional side air bags for crashes to the vehicle sides.

The air bag system in your police vehicle may include optional side air bags for front and rear occupants. Most front-to-rear side air bags are designed to deploy downward from the interior roof sides to the bottom of the door windows.

Can Specialty Vehicle Security Barriers be mounted within the side air bag deployment zones?

No. The side air bags inflate extremely fast because of the nature of side crashes to the vehicle. Mounting a security barrier behind the front seats with the ends placed within the side air bag deployment zones will result in unintended interaction between the barrier and the inflating side air bags. To reduce the risk of injury to the vehicle occupants, GM recommends that the side air bag zones be kept free of any customer installed equipment.

Customer furnished equipment installed to the vehicle roof.

Your police vehicle is designed with an interior roof cover system which includes internal components for the interior lamps and wiring. The roof system may also include optional side air bag components. Inflation devices may be mounted on the vehicle roof side behind the rear doors as well as air bag tethers retained to the windshield pillars. Care must be taken to avoid damage to these components or interference with their operation when installing roof mounted equipment such as emergency lamps and communication antennas.

Recommended GM service procedures must be followed to remove and re-install the instrument panel top pad to ensure that the top pad will release properly in the event of a passenger air bag deployment.

On the right half of the top pad closest to the passenger air bag module, GM recommends that no equipment be mounted. When mounting equipment on the driver side of the top pad, GM recommends that the total mass of the top pad mounted special equipment not exceed 8 pounds (3.6 kilograms), since the top pad tends to rotate about the left end.

Fasteners used to secure special equipment to the instrument panel top pad, the windshield glass, or to the windshield upper frame (header), should be selected to ensure that these devices will remain attached during a vehicle crash and possible air bag deployment.

Can the installation of push bumpers on the front end of the vehicle affect the deployment of the air bag?

General Motors is not aware of adverse effects during crash events from the many push bumpers that have been installed on GM police vehicles. Because there are many styles of push bumpers available with varying crash characteristics, installation of push bumpers may or may not affect deployment timing of the air bags. Push bumpers should be mounted to avoid modifying the vehicle structure and interfering with the front air bag sensors mounted on the upper radiator support cross member.

Two front impact sensors are installed in General Motors vehicles. Do not relocate or disconnect the front sensors. The location and orientation of the front sensors are critical for correct operation of the air bag system. Avoid mounting components on or near the sensors. Push bumper styles with vertical pushing members that are in fore-aft alignment with the front air bag sensors are not recommended.

How long will the air bag remain inflated?

It takes approximately 1/20th of a second to fully inflate the frontal air bags. This is faster than the blink of an eye. The air bags begin to deflate immediately, helping to stop the occupants more gradually.

Can the air bag system be re-used?

No. The air bags are designed to inflate only once. After inflation some new parts will be required. These will include the air bag module and possibly other parts. (A competent service technician with access to the vehicle's service manual and the required tools should replace the required components after a deployment crash.)

I've heard that the dusts that are released into the passenger compartment from the air bag are harmful. Is this true?

For most people, the only effect the dusts will produce is some irritation of the throat and eyes, and that is only if the occupant remains in the vehicle for many minutes after the air bag deployment with no ventilation and windows closed. However, some people with asthma may develop an asthmatic attack from inhaling the dusts. If this happens, they should first treat themselves the same way their doctor has advised them to treat any other asthma attack, and then immediately seek medical treatment.

When should an air bag inflate?

The driver's and right-front passenger's frontal air bags are designed to inflate in moderate to severe frontal or near-frontal crashes. But they are designed to inflate only if the impact speed is above the system's designed "threshold level."

In addition, if your vehicle has "dual stage" frontal air bags, these air bags tailor the amount of restraint according to crash severity. For moderate frontal impacts, the air bags inflate at a level less than full deployment. For more severe frontal impacts, "dual stage" frontal air bags deploy at full levels.

If the front of your vehicle goes straight into a wall that doesn't move or deform, the threshold level of the reduced deployment is about 12 to 16 mph (19 to 15 km/h), and the threshold level for a full deployment is about 18 to 24 mph (29 to 28.5 km/h). The threshold level can vary, however, with specific vehicle design, so that it can be somewhat above or below this range.

If your vehicle strikes something that will move or deform such as a parked car, the threshold level will be higher. The driver's and right-front passenger's frontal air bags are not designed to inflate in rollover, side impacts, or rear impacts, because inflation would not help the occupant.

Head curtain side air bags are designed to help reduce the risk of head and neck injuries to front and rear seat occupants on the near side of certain side-impact collisions. Always use safety belts and the correct child restraints for your child's age and size, even in vehicles equipped with air bags. Children are safer when properly secured in a rear seat. See your vehicle Owner's Manual and child safety seat instructions for more information.

Seat mounted side impact air bags are designed to inflate in moderate to severe side crashes. The side impact air bags will inflate if the crash severity is above the designed "threshold level." The threshold level can vary with specific vehicles design. The side impact air bags are not designed to inflate on frontal or near-frontal impacts or rear impacts, because inflation would not help the occupant.

Roof rail mounted head-curtain air bags are designed to inflate in moderate to severe side crashes. In addition, certain vehicles have head-curtain air bags which are also designed to inflate in situations where an impending rollover condition is identified by the vehicle's rollover sensing system and/or frontal or near-frontal impacts if the crash severity is above the designed "threshold level".

Safety belt pretensioners at the driver and front passenger seat positions are designed to deploy in frontal, near-frontal, side, and rear crashes that exceed the "threshold level" of crash severity to help reduce slack in the safety belt. Safety belt pretensioners will also deploy in impending rollover situations.

I've heard that a deployed air bag produces what appears to be smoke. Is the air bag hot?

After the bag has deployed in a crash, the air bag itself will not be hot to touch. Some components within the air bag module will be hot for a short time. A small amount of smoke coming from a deployed air bag module is normal and should not be cause for concern.

Also, when the nitrogen gas is vented out of the air bag, small particles from inside the bag are also vented into passenger compartment. These airborne particles look like smoke and some particles are deposited as residue on and around the air bag.

If my vehicle has air bags, why should I have to wear my safety belt?

Air bags are in many vehicles today and will be in most of them in the future. But they are supplemental systems only; so they work with safety belts - not instead of them. Every air bag system ever offered for sale has required the use of safety belts. Even if you're in a vehicle that has air bags, you still have to buckle up to get the most protection. That's true not only in frontal collisions but especially in side and other collisions.

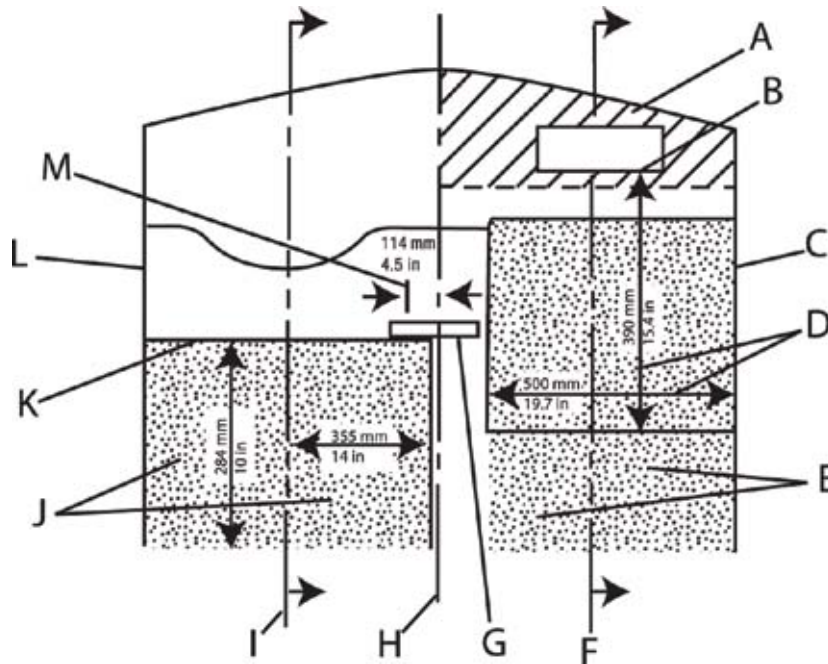

TOP VIEW OF INSTRUMENT PANEL AND APPROXIMATE DEPLOYMENT AREA OF THE AIR BAG ZONE

- A. Passenger side instrument panel top surface zone
- B. Passenger side air bag module trim panel – rear edge
- C. Passenger side door
- D. Approximate dimensions of inflated air bag
- E. Passenger side air bag deployment zone
- F. Passenger centerline
- G. Inside rearview mirror
- H. Vehicle centerline
- I. Driver centerline
- J. Driver side air bag deployment zone
- K. Front of steering wheel
- L. Driver side door
- M. Shift selector arc

Head curtain side air bags are designed to help reduce the risk of head and neck injuries to front and rear seat occupants on the near side of certain side-impact collisions. Always use safety belts and the correct child restraints for your child's age and size, even in vehicles equipped with air bags. Children are safer when properly secured in a rear seat. See your vehicle Owner's Manual and child safety seat instructions for more information.

Note: All dimensions are approximate and subject to change.

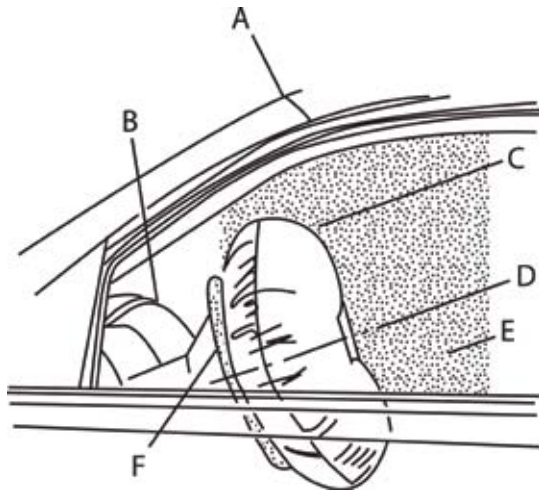

SIDE VIEW OF DRIVER SIDE
AIR BAG DEPLOYMENT ZONE

- A. Top edge of windshield
- B. Top of instrument panel
- C. Inflated air bag – steering wheel
- D. Centerline of steering column at mid-tilt
- E. Driver air bag deployment zone
- F. Front of steering wheel

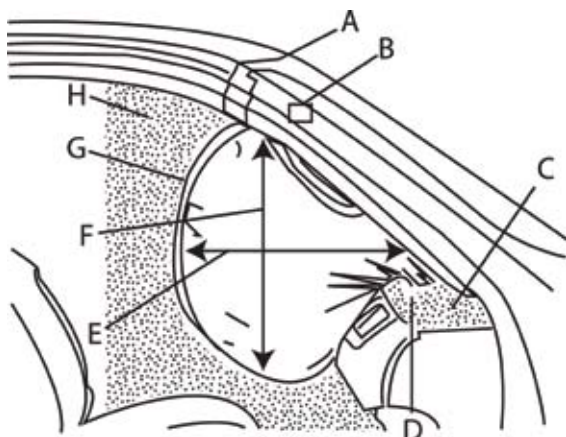

SIDE VIEW OF PASSENGER SIDE AIR BAG
DEPLOYMENT ZONE

- A. Top edge of windshield
- B. Inside rearview mirror
- C. Instrument panel top surface zone
- D. Passenger side air bag module trim panel – rear edge
- E. Inflated air bag – horizontal dimension approximate 15.4 in (390 mm)
- F. Inflated air bag – vertical dimension approximate 9.3 in (490 mm)
- G. Inflated air bag – instrument panel
- H. Passenger air bag deployment zone

Head curtain side air bags are designed to help reduce the risk of head and neck injuries to front and rear seat occupants on the near side of certain side-impact collisions. Always use safety belts and the correct child restraints for your child's age and size, even in vehicles equipped with air bags. Children are safer when properly secured in a rear seat. See your vehicle Owner's Manual and child safety seat instructions for more information.

Note: All dimensions are approximate and subject to change.

24 | AIR BAG DIMENSIONS – TAHOE PPV AND 5W4

HEAD CURTAIN AND FRONT SEAT-MOUNTED SIDE IMPACT AIR BAG DEPLOYMENT ZONES
PASSENGER SIDE SHOWN, DRIVER SIDE SIMILAR

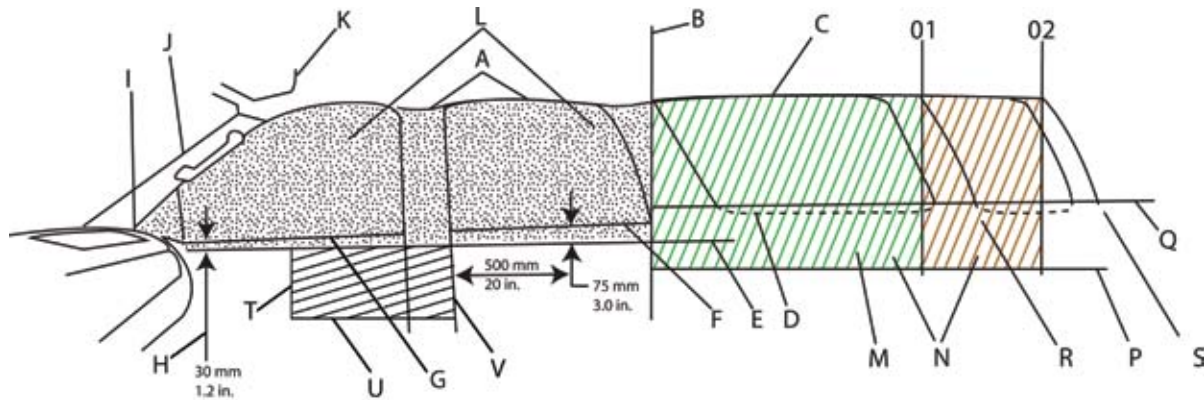

Tahoe/Suburban/Silverado Crew Cab Seat Rows 1 and 2

- A. Top of deployment zone – along head curtain at edge of headliner
- B. Back of deployment zone – at rear top corner of rear door pad
- C. Rear quarter window
- D. Bottom outside edge of rear quarter window
- E. Bottom of air bag deployment zone – parallel to outside bottom edge of rear quarter glass
- F. Top edge of rear door pad
- G. Top edge of front door pad
- H. Dimension at mirror patch from top edge of front door pad
- I. Front of deployment zone at front upper corner of front door pad
- J. Windshield pillar trim with grab handle
- K. Visor
- L. Deployment zone - Tahoe seat rows 1 and 2

Tahoe/Suburban 3rd Row Seats

- M. Deployment zone - Tahoe 3rd seat
- N. Deployment zone - Suburban 3rd seat
- O. Rear zones at back corner of headliner: 1 Tahoe, 2 Suburban
- P. Bottom of 3rd seat zone at rear side trim cup holders
- Q. Top edge of rear quarter trim at window
- R. Rear of Tahoe
- S. Rear of Suburban

Tahoe/Suburban/Silverado Crew Cab Seat Air bag

- T. Center of door trim pull handle
- U. Top of surface of outboard front seat cushion
- V. Back edge of center pillar trim

HEAD CURTAIN AND FRONT SEAT-MOUNTED SIDE IMPACT AIR BAG DEPLOYMENT ZONES
VIEW FROM REAR CARGO AREA

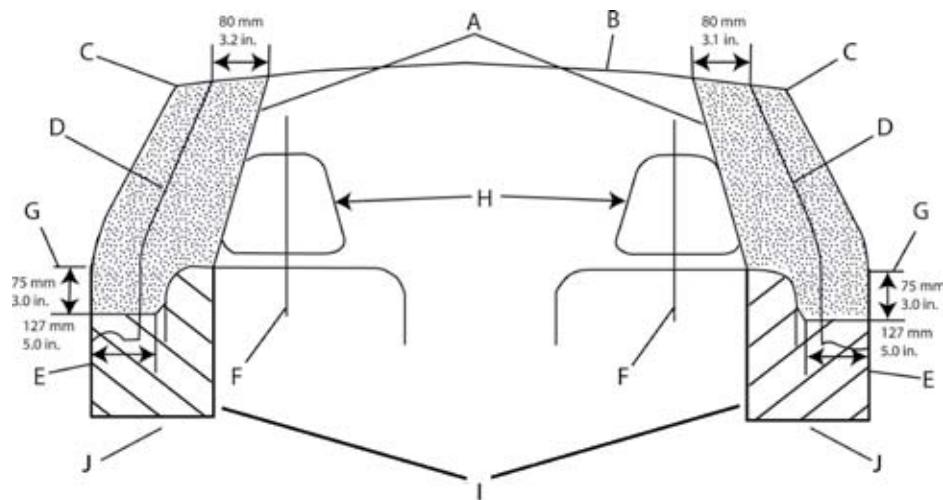

- A. Head curtain air bag deployment zone
- B. Underside of headliner
- C. Edge of headliner
- D. Inner center pillar trim
- E. Inner door pad
- F. Seat centerline
- G. Bottom of door windows
- H. Front seat headrests
- I. Seat-mounted side impact air bags deployment zone front seat
- J. Top surface of outboard front seat cushion

Head curtain side air bags are designed to help reduce the risk of head and neck injuries to front and rear seat occupants on the near side of certain side-impact collisions. Always use safety belts and the correct child restraints for your child's age and size, even in vehicles equipped with air bags. Children are safer when properly secured in a rear seat. See your vehicle Owner's Manual and child safety seat instructions for more information.

Note: All dimensions are approximate and subject to change.

WIRING PROVISIONS FOR 12-VOLT BATTERY POWER SUPPLY

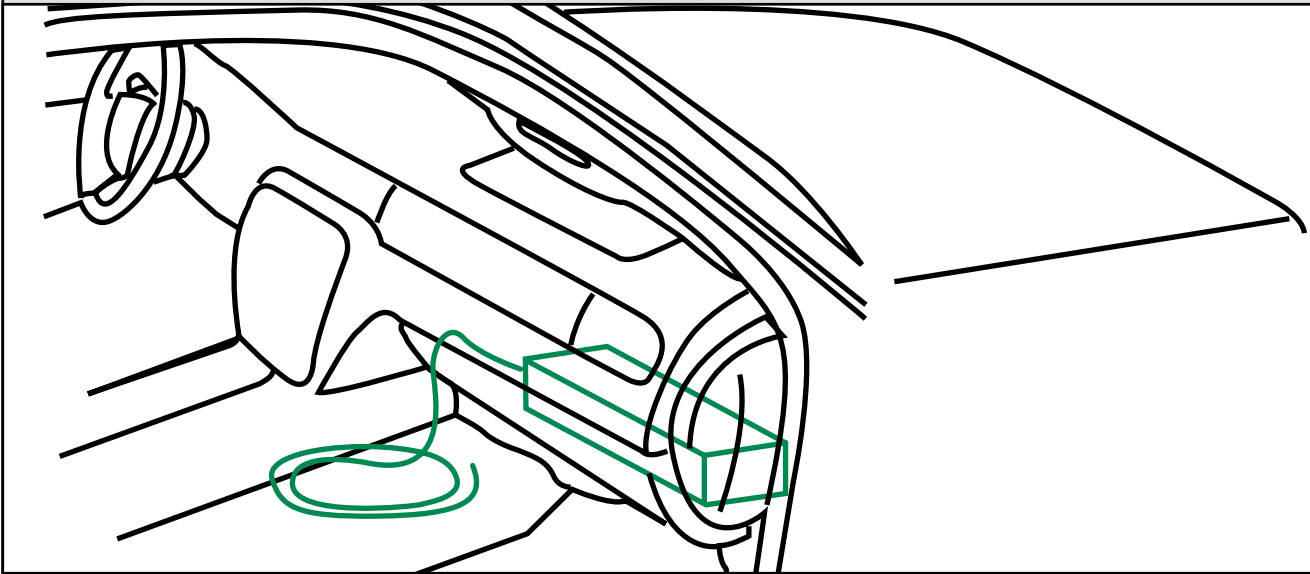

Your vehicle is equipped with wiring provisions for a 12-volt battery power supply. Refer to the following information when adding electrical system. The wiring harness is located below the instrument panel near the center of the vehicle. The following information describes the breaker and relay location and provides a wiring diagram to aid in connecting customer equipment.

The 12-volt battery power is supplied through two underhood mega fuses, one 125-amp and one 60-amp. This underhood power is fed to the breaker/relay center via a harness that passes through the driver side front of the dash, and routed across the instrument panel to a position forward of the glove box. The breaker/relay center is mounted to the instrument panel structure forward of the glove box. The center includes a plastic bracket, two relays, two 30-amp breakers and three 50-amp mega circuit breakers.

Two 30-amp breakers supply power from the underhood 60-amp mega fuse through the contacts of the control relays to a 12-gauge (3.0 mm²) blunt cut wires. These two blunt cut leads are part of wire coiled under the instrument panel near the center of the vehicle.

Each relay is operated by a 0.5 mm² blunt cut, light or dark blue control lead includes in a 3-foot (91 cm) loop of wire under the instrument panel.

Three 50-amp mega circuit breakers, protected by three fusible links, supply power directly from the underhood 125-amp mega fuse through three, 10-gauge (5.0 mm²) wires. Two of the wires are routed through the body harness to a split buss junction block to the left rear of the cargo area and secured near the jack and tools. This 3-foot (91 cm) of coiled wires can be accessed by removing the cup holder on the top of the trim panel. The third 10-gauge (5.0 mm²) wire is a blunt cut lead, which is part of the 3-foot (91 cm) loop of wire coiled under the instrument panel near the center of the vehicle.

An 8-gauge (8 mm²) ground lead is also provided and it is located under the front passenger sill plate. It can be accessed by removing the sill plate and pulling the loop of wire at the front of the plate, the lead is 3-feet (91 cm) long.

Blunt cut ignition control power and signal circuits are also included in the wire coiled under the instrument panel near the center of the vehicle. They include:

- A yellow, 20-gauge (0.5 mm²) circuit, HOT in ACCESSORY, RUN or RAP (Retained Accessory Power)*
- Pink, 20-gauge (0.5 mm²) circuit, HOT in START/RUN (7-amp maximum load)
- A yellow/black, 20-gauge (0.5 mm²) transmission park signal. This circuit provides switched power when the transmission is in P (Park) and the engine is running. The circuit is at 0-volts when the transmission is in any other position, i.e., R (Reverse), N (Neutral), D (Drive) or M (Manual 6-1). Note that the circuit is also at 12-volts with the transmission in P (Park) and the ignition is OFF. To avoid the possibility of undesired parasitic electrical load with the ignition is OFF it is suggested that the Park/Signal circuit be isolated by routing it through the normally open contacts of a customer furnished ignition controlled relay.*
- A dark green/white, 20-gauge (0.5 mm²) Vehicle Speed Signal (VSS) provides 4,000 pulses per mile.

The breaker and relay center is located behind and above the instrument panel storage compartment. Remove contents from the storage tray. Using the tab at the back of the compartment drop the tray down gently toward the floor. You will find the breaker/relay center above the right rear corner of the storage compartment. The bracket is attached to the instrument panel structure with two screws. It will hang from the hinge.

** These two circuits share a 15-amp fuse. (10-amp combined maximum load)*

Note: Wiring diagrams for these options are shown in the Police Package owner's manual supplement (shipped in glove box).

WIRING DIAGRAM FOR 12-VOLT BATTERY POWER SUPPLY

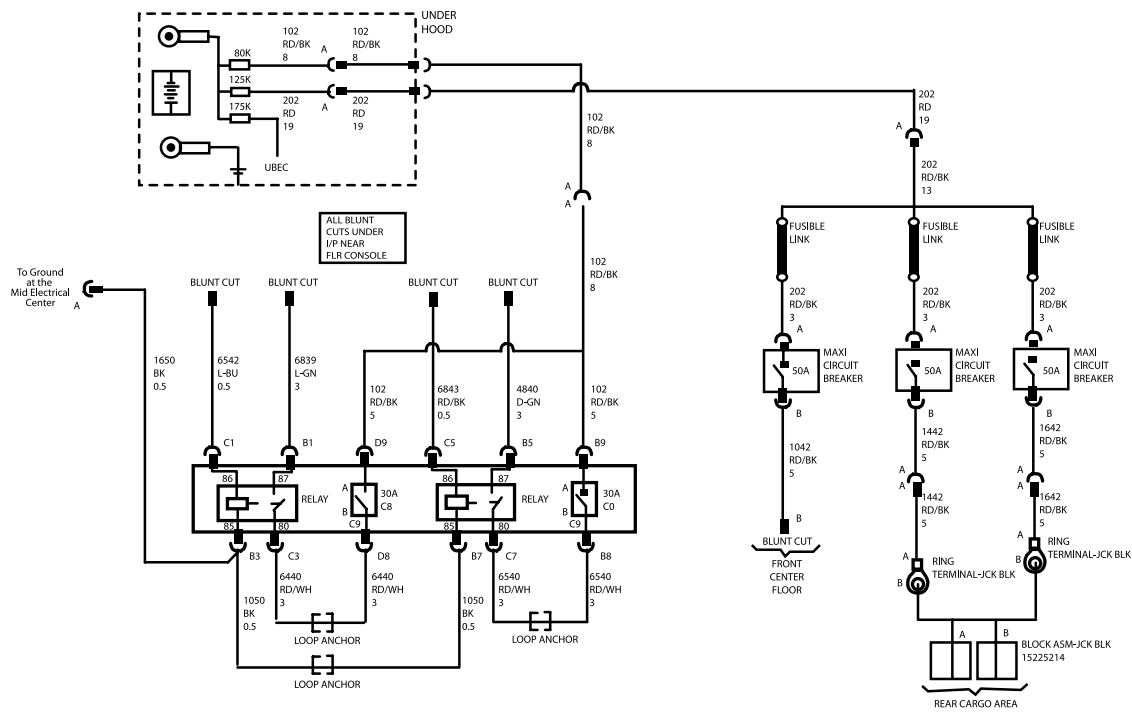

CONTROLLED POWER AND SIGNAL CIRCUITS WITH 12-VOLT POWER SUPPLY

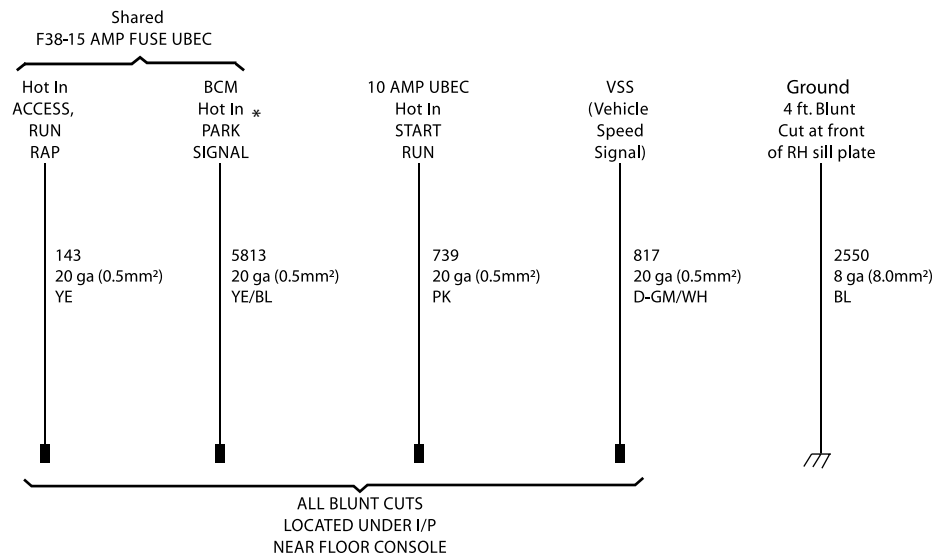

* Zero volts out of PARK, engine running; HOT in PARK with ignition OFF.

Note: Wiring diagrams for these options are shown in the Police Package owner's manual supplement (shipped in glove box).

AUXILIARY BATTERY POWER JUNCTION BLOCK AND GROUND STUDS

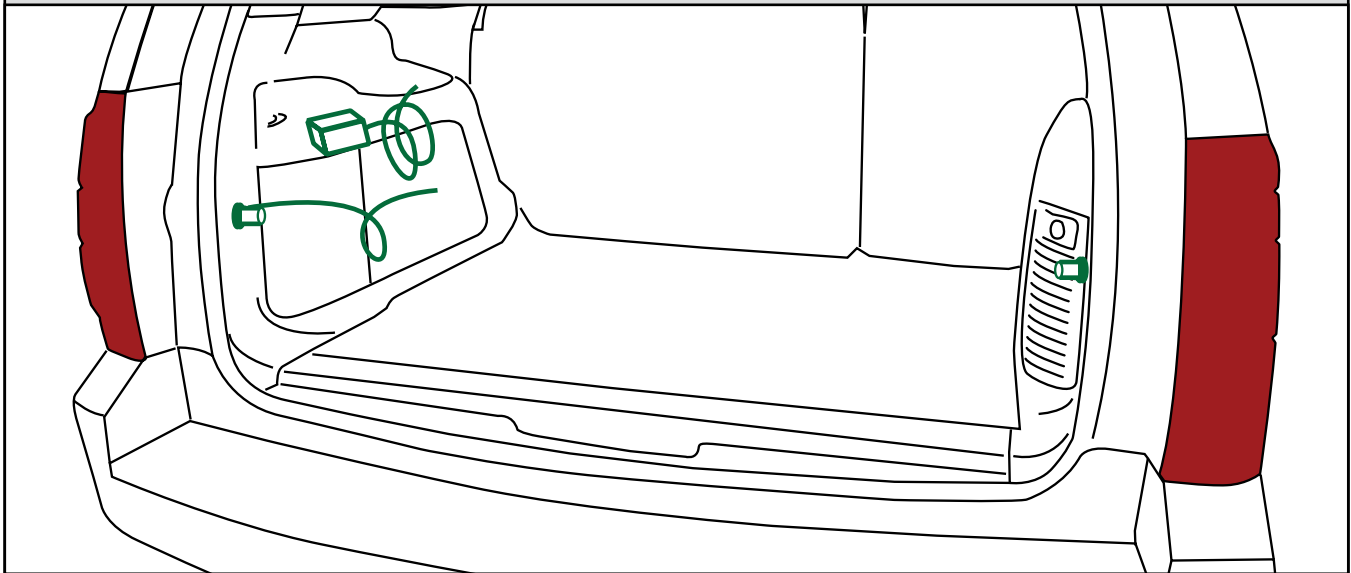

An auxiliary power junction block is located within the driver's side rear cargo area jack stowage compartment. This junction block is split to provide two circuits for connection to customer-furnished equipment directly to the battery through separate 50-amp circuit breakers. These circuit breakers are located in the breaker/relay panel forward of the instrument panel glove box. A maximum load of 100-amps (1,200-watts) can be connected.

This junction block is connected to a coiled 5-foot (1.5 m) branch of rear body harness and fastened near the jack. Mounting of the junction block can be at customer-selected rear cargo area locations permitted by the branch harness length and using customer-furnished mounting hardware.

The junction block should not be attached to the interior trim plastic components without appropriate backing hardware to the mounting bolts.

Grounding studs are located on the left and right sides of the liftgate opening.

Note: Wiring diagrams for these options are shown in the Police Package owner's manual supplement (shipped in glove box).

WIRING PROVISIONS FOR VEHICLE GRILLE LAMPS AND SPEAKER/SIREN – OPTION 6J3

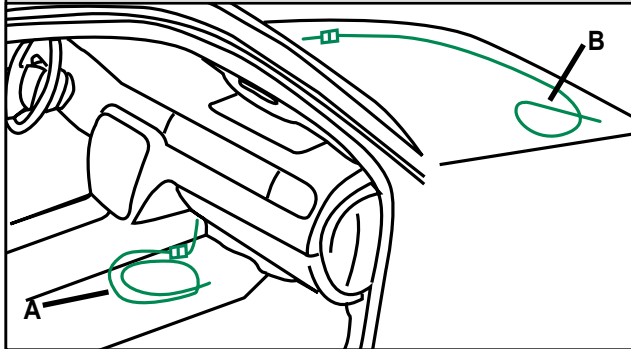

- A. Blunt cut ends for the customer-furnished grille lamps and customer-furnished siren/speaker
- B. Control wires from in-line connector in forward lamp harness for customer-furnished grille lamps and speaker

The SEO 6J3 wiring provision has a 5-foot (1.5 m) harness coiled underneath the instrument panel on the passenger side. The wiring circuits are routed from under the instrument panel to a 1-foot (30 cm) coil secured in the area behind the grille. There are four 16-gauge (1.0 mm²) wires for connecting to the grille lamps (GRY, TAN) and siren speaker (LT BU, LT GN)

The SEO 6J3 wiring provision also includes one 18-gauge (0.8 mm²) control wire for the SEO 6J7 Exterior Lamps Emergency Flashing System.

When option 6J7 is installed without option 6J3, only the dark green/red control wire is proved for connection to customer-furnished 12-volt switching to turn the Emergency Flashing System on or off.

WIRING DIAGRAM FOR OPTION 6J3 AND OPTION 6J7

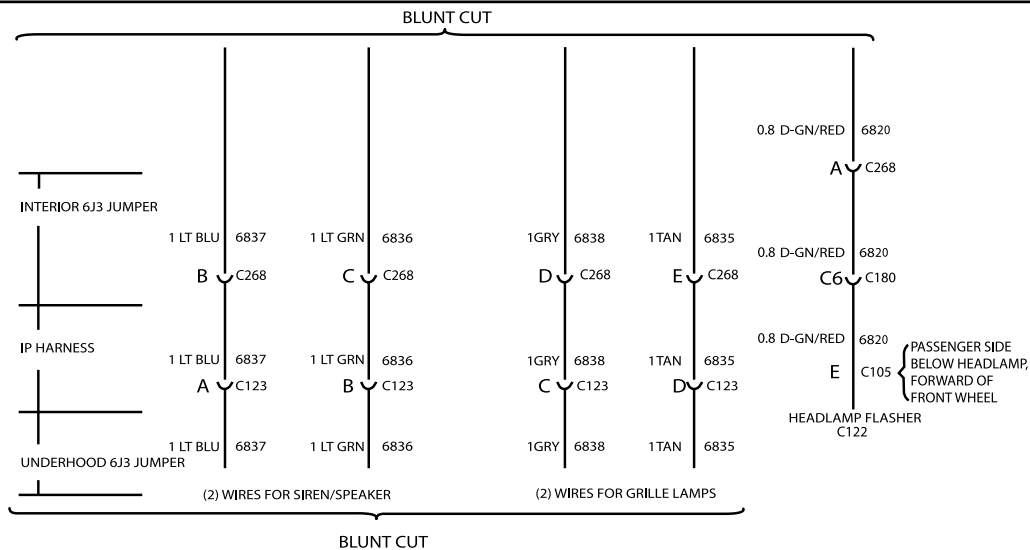

Note: Wiring diagrams for these options are shown in the Police Package owner's manual supplement (shipped in glove box).

WIRING PROVISION FOR FRONT SPEAKERS – OPTION WX7

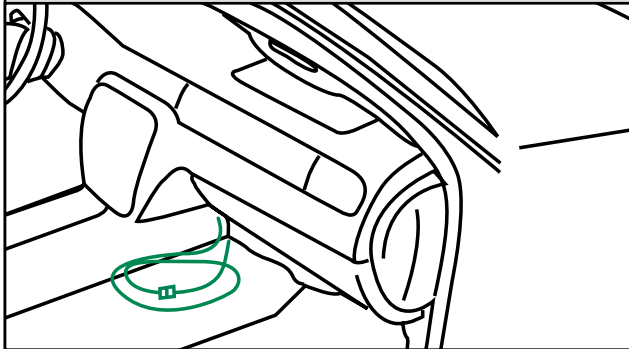

This provision permits customer connection of a switch to select either horn of siren operation when the horn pad is pressed.

A 22-gauge (0.35 mm²) wire is connected to an in-line connector in the horn circuit of the instrument panel harness under the instrument panel. The end of this harness extension is a 5-foot (1.5 m) loop of wire coiled under the center of the instrument panel.

WIRING DIAGRAM FOR OPTION 6J4 IN-LINE CONNECTOR

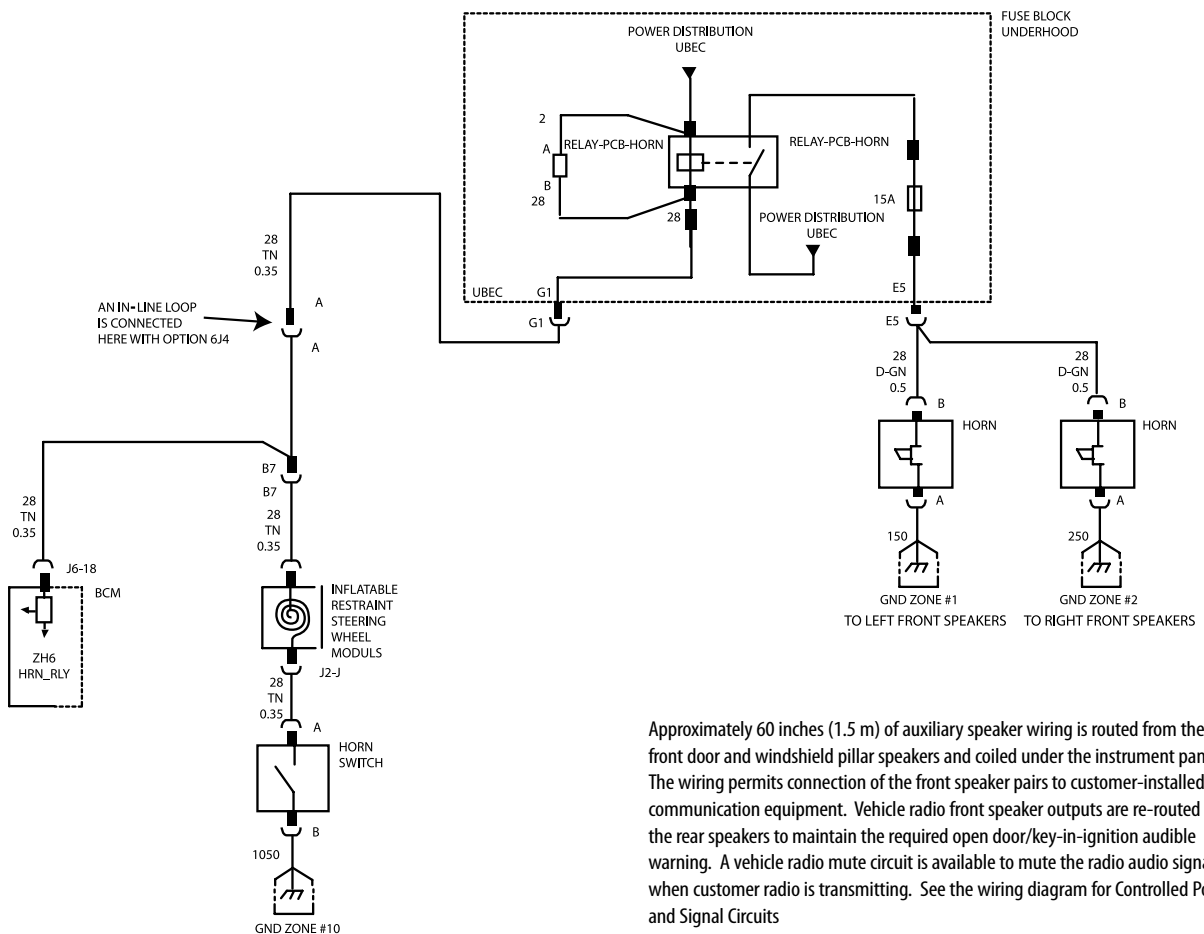

Approximately 60 inches (1.5 m) of auxiliary speaker wiring is routed from the front door and windshield pillar speakers and coiled under the instrument panel. The wiring permits connection of the front speaker pairs to customer-installed communication equipment. Vehicle radio front speaker outputs are re-routed to the rear speakers to maintain the required open door/key-in-ignition audible warning. A vehicle radio mute circuit is available to mute the radio audio signal when customer radio is transmitting. See the wiring diagram for Controlled Power and Signal Circuits

Note: Wiring diagrams for these options are shown in the Police Package owner's manual supplement (shipped in glove box).

EXTERIOR LAMP EMERGENCY FLASHING SYSTEM - OPTION 6J7

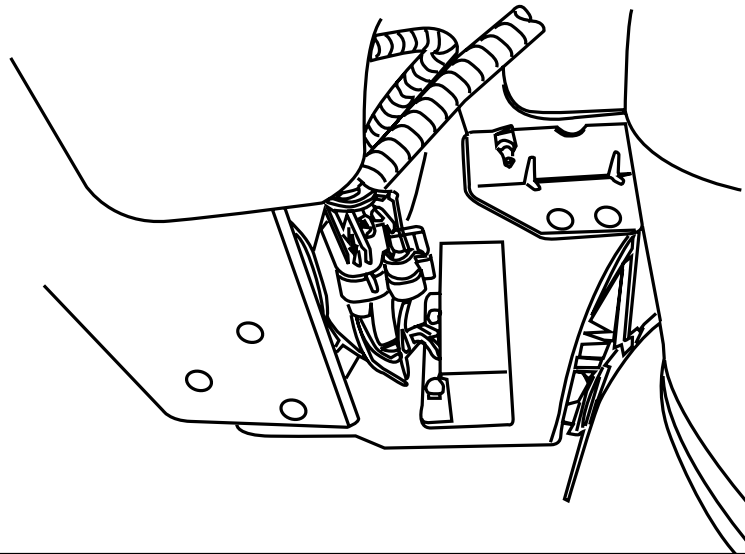

Option 6J7 provides a high beam headlamps flashing module, rear lamps flashing control wire for a customer-furnished switch to turn the module on or off. The flasher control wire is coiled under the center of the instrument panel. This control lead may be combined with the interior wiring leads for option 6J3 when that option is ordered with option 6J7.

The headlamps flashing module is located below the passenger's side front headlamp and forward of the passenger's side front wheel. The module is connected to an in-line connector in the forward lamp harness. The headlamps flashing module is activated by the application of 12-volts to a dark green/red wire coiled in the passenger's side footwell. When activated, the driver's and passenger's side high beam headlamps and the high beam instrument panel cluster lamp will flash alternately at 2.4 flashes per second.

When the headlamps flashing module is turned on, the module sends a signal to the Body Control Module (BCM). The BCM alternately flashes the stop lamps and backup lamps. Depressing the brake pedal will override the stop lamp flashing and placing the transmission in reverse will override the backup lamp flashing.

Activation of the headlamp and rearlamp flashing can be separated.

During daylight conditions, the Daytime Running Lamps (DRL) are automatically turned off whenever the headlamps flashing module is activated. During nighttime conditions, the low beam headlamps turn on automatically while the high beam headlamps flash. Turning on the high beam headlamps manually with the turn signal/multifunction lever will override the flashing module and the high beam headlamps will operate continuously.

A 20-amp fuse protects the flasher module circuit. This fuse is located in the underhood fuse block in the engine compartment on the driver's side of the vehicle. See "Fuses and Circuit Breakers" in the "Service and Appearance Care" section of your Tahoe owner's manual for more information.

When it is dark outside, the tail lamps will turn on automatically. The Center High-Mounted Stop lamp (CHMSL) will not flash and will operate only when the regular brake pedal is pressed.

FORWARD LAMP HARNESS IN-LINE CONNECTOR FOR USE WITH HEADLAMPS FLASHER MODULE, OPTION 6J7

				C122	
GROUND	250	0.8 BLK	A	←	
LH HI BEAM	711	0.35 D-GN/WH	B	←	B 711 0.35 D-GN/WH
* HDLP WASH	3640	0.8 RD/WH	C	←	
RH HDLP HI	311	0.5 L-GN/BK	D	←	D 311 0.5 L-GN/BK
CONTROL	6820	0.35 D-GN/RD	E	←	
BCM	6841	0.5 D-BU/YE	F	←	

* FUSE BLOCK, UNDERHOOD

Note: Wiring diagrams for these options are shown in the Police Package owner's manual supplement (shipped in glove box).

WIRING PROVISIONS FOR EMERGENCY VEHICLE ROOF LAMP - OPTION TRW

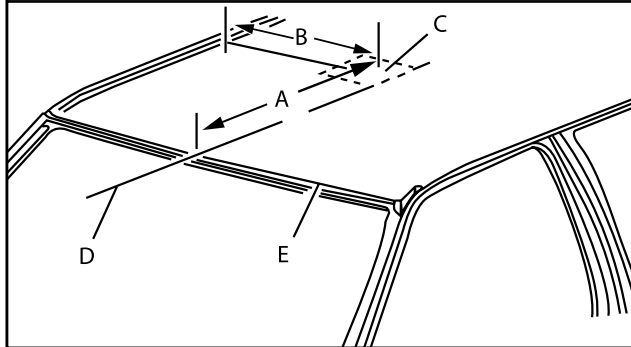

- A. 25.39-inches (645 mm)
- B. 17.32-inches (440 mm)
- C. 3.94-inches (100 mm) square
- D. Roof centerline
- E. Roof edge

Battery power is supplied through a 30-amp fuse to a wiring harness located in the roof. Power is controlled with a switch located in the overhead console. The customer or vehicle upfitter must complete the installation to an added accessory such as an emergency beacon lamp.

Maximum rated electrical load is 21-amp (250-watts). The added electrical requirements must not exceed 21-amp (250-watts). Running the accessory for long periods of time with the engine off may run the battery down.

WIRING DIAGRAM FOR OPTION TRW EMERGENCY ROOF LAMP

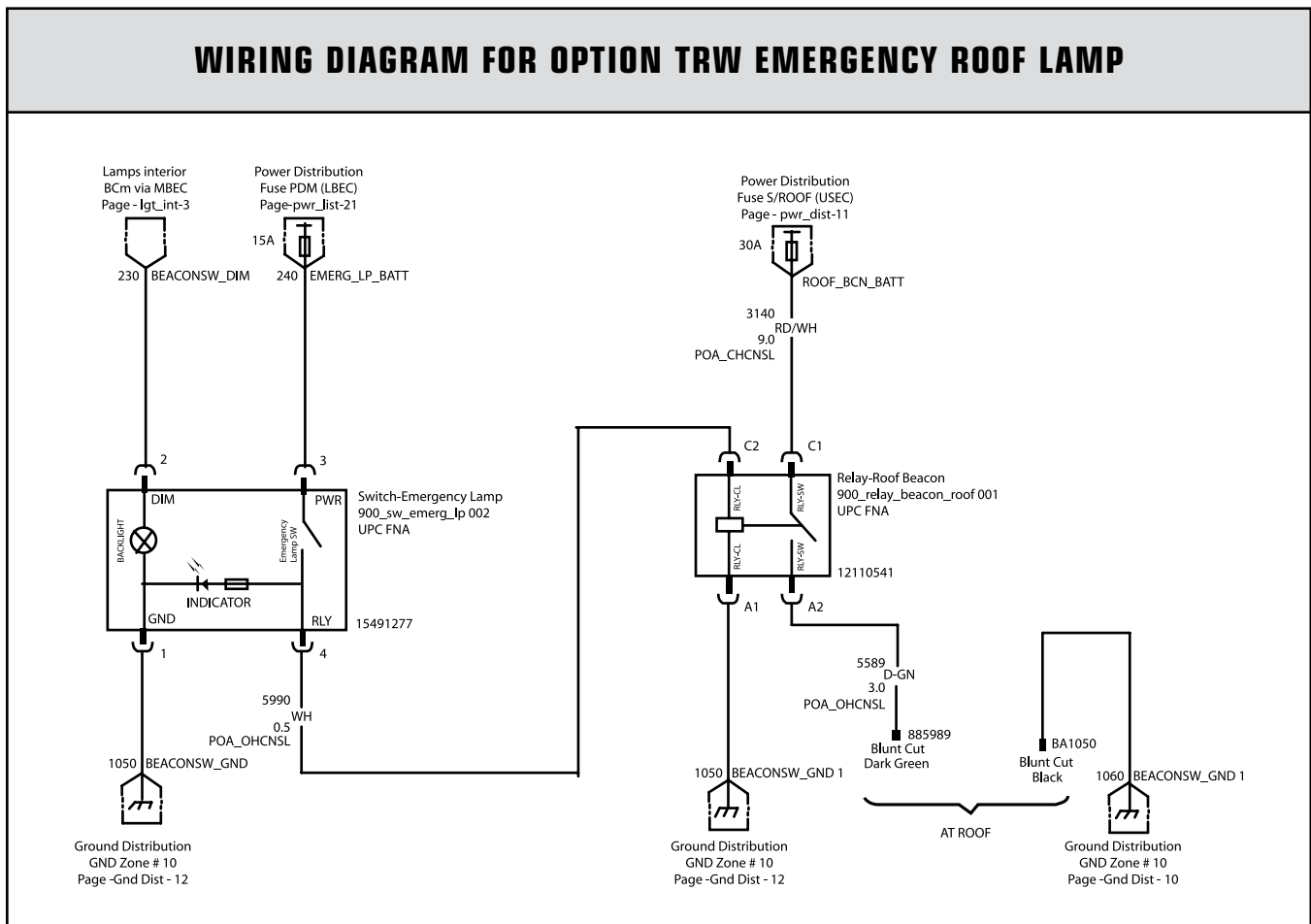

Note: Wiring diagrams for these options are shown in the Police Package owner's manual supplement (shipped in glove box).

WIRING PROVISIONS FOR FRONT DOOR SPEAKERS - OPTION WX7

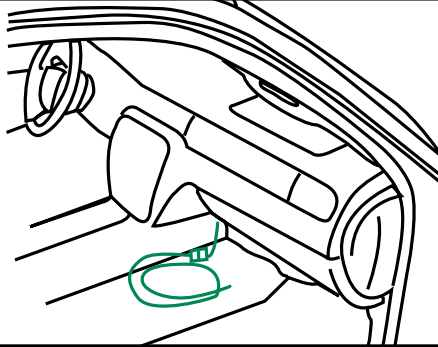

About 65-inches (165 cm) of auxiliary speaker wire is run from the instrument panel radio connector and is coiled under the center of the instrument panel. The wiring permits the connection of front door speakers to customer-installed communication equipment.

Radio outputs from the front speakers are sent to the rear speakers to maintain the required open door/key-in-ignition reminder chime.

WIRING DIAGRAM FOR OPTION WX7 IN-LINE CONNECTOR

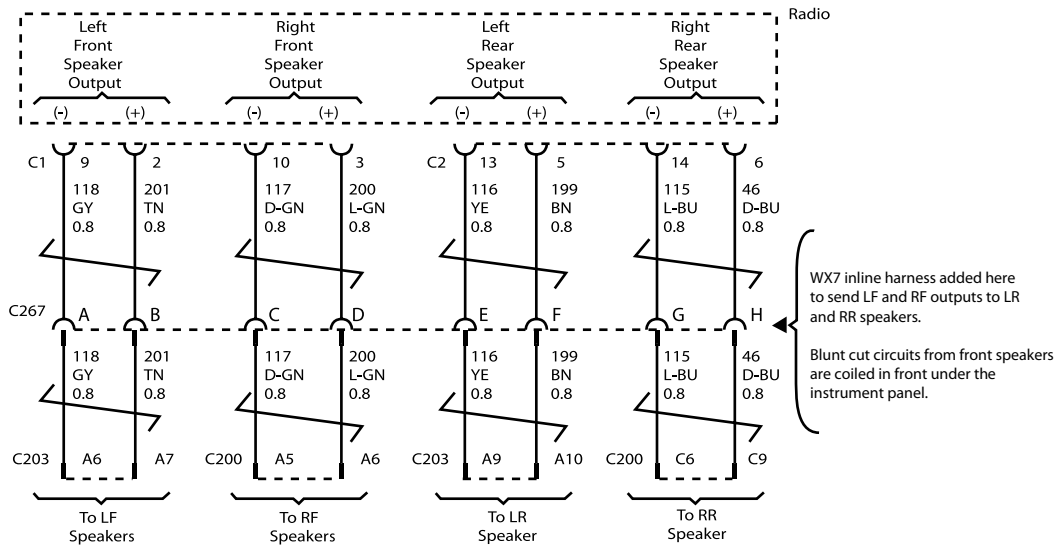

Note: Wiring diagrams for these options are shown in the Police Package owner's manual supplement (shipped in glove box).

GM offers Anti-Lock Brake Systems as standard or optional on all North American passenger vehicles and light truck lines. The computerized Anti-Lock Braking System (ABS) is designed to keep the vehicle's wheels rotating as the brakes are applied to assist the driver in achieving a controlled stop. Sensors monitor how fast the wheels rotate and feed the data continuously to the ABS computer. The vehicle's brakes slow each wheel as the brake pedal is applied. However, when ABS is activated due to road conditions, the system repeatedly releases and applies pressure to the brakes. The wheels can keep rolling, thus retaining steering ability and enhanced stability while providing a higher braking force on most surfaces than a locked wheel provides.

How exactly does ABS work?

In cars without ABS, hitting the brakes can cause the wheels to lock, leaving you unable to steer the vehicle until you decrease the pressure so the wheels can roll again. With an ABS, as you apply the brakes, the ABS computer monitors the wheel speed sensor information. If the computer senses that a wheel is approaching lock up, it sends a signal to the hydraulic modulator to reduce, then to reapply, brake pressure several times a second for as long as you maintain firm pressure on the brake pedal. The process is much like the threshold braking technique used with conventional brakes. However, ABS does it much faster and more accurately than any driver can, leaving you free to focus on steering away from obstacles.

Does ABS reduce stopping distances?

Yes, in braking situations where the wheels on a non-ABS equipped vehicle would lock up, ABS will generally provide shorter controlled stopping distance. The amount of improvement in stopping distance depends on many factors, including the road surface, severity of braking, initial vehicle speed, etc. On some surfaces, such as gravel roads, braking distances can be longer, but you will still have the control benefits of ABS. The important capability of ABS is control. ABS provides improved vehicle steerability and stability when braking.

What can affect the ABS advantage?

It is important that you follow the maintenance schedule recommended in the owner's manual of the vehicle, tires should be at their proper inflation level, the brake pads should be checked regularly, etc. While driving, you should sit comfortably, so that your hips are back in the seat and your knees are bent, even while braking. Your foot should be positioned so that your heel is on the floor and your toes are secure on the lower half of the pedal. And, though ABS may reduce stopping distance, remember: The faster you go, the longer it takes you to stop. Keeping a safe distance between you and the vehicle in front of you is always necessary, even with ABS.

What happens if ABS becomes inactive?

The ABS electronic control unit has on-board diagnostic capability. If a fault is detected, the vehicle will revert to the base brake system, and the ABS telltale on the dash will be illuminated. Should this happen, the vehicle should be taken to a dealership for repair as soon as possible.

How do I use ABS?

Depress and hold the pedal. DO NOT PUMP THE BRAKES (that prevents the system from working). Just hold the brake pedal down and let the ABS work for you. You may feel the brake pedal vibrate, or you may notice some noise, but this is normal as the system works for you.

Should I drive an ABS equipped vehicle differently than I would drive a vehicle with conventional brakes?

Most of the time, under normal driving circumstances, there is no difference, and you should always drive with the same caution and care. It is important to realize that ABS only makes a difference when it is activated—when you have to brake hard—and that would only be when the computer senses that a wheel is approaching lock up. When ABS activates keep steady pressure on the brake pedal and then let the ABS work for you. Don't pump the brakes or try to find the threshold. Simply hold the brake pedal down and steer if necessary to avoid an obstacle.

Is ABS always active?

ABS is always available, but not always activated. ABS is activated only when the brake pedal is applied and the computer detects an impending wheel lock condition.

Can older cars be retrofitted with ABS?

No! The brake system is one of the most important features on any passenger vehicle. Several products, which tap into the master cylinder and/or brake system performance, are being sold in the aftermarket. Some of these products imply performance similar to new vehicle anti-lock brake systems.

However, contrary to their claims, add-on systems, which deplete fluid from the master cylinder on brake apply may actually increase a vehicle's stopping distance. This may cause the vehicle to fail to comply with Federal brake standards.

Does ABS always activate at the same speed?

No, the system operates when the computer detects wheel lockup, at any speed above 8 mph.

Will ABS wear out a vehicle's brakes sooner?

A properly maintained brake system will be unaffected by ABS operation under typical driving conditions.

Are there different types of ABS?

Yes, there are rear wheel anti-lock systems (RWAL) used on some trucks and four-wheel ABS available on cars and trucks.

Do Federal Safety Standards mandate ABS?

No. Federal standards establish minimum braking performance requirements that all vehicles must meet, but do not specify how they should be met. It should be noted that even a vehicle with failed ABS meets the Federal safety standard for stopping distances.

Will a tire size change affect ABS?

Use of tires other than original equipment may affect ABS performance. Owners should consult and follow the recommendations contained in the vehicle owner's manual regarding replacement tire size. *Note: ABS will work with original equipment spare tire or tire chains. However, performance is reduced.*

Do insurance companies give a discount for ABS?

Yes, many insurance companies give discounts that range from 5% to 10%. In the states of New York and Florida all insurance companies are required to give an ABS discount of 5% on certain coverages such as bodily injury, property damage, collision, and personal injury protection. In other states the discount varies from insurance company to insurance company. When buying auto insurance, always ask your insurance agent if his/her company gives a discount for vehicles equipped with anti-lock brakes.



IMPORTANT DRIVING SAFETY TIPS



- A. Always maintain a safe following distance.** ABS does not allow you to stop on a dime. (Generally a 2-second following distance is considered safe in ideal conditions.) Watch the vehicle in front of you pass a fixed marker (such as a sign). Count seconds—one-thousand-one, one-thousand-two-until your front bumper reaches the marker. If you do not count out two seconds, then you are too close to the vehicle in front of you. Also, if the roads are wet or icy, or visibility is poor, you should increase your following distance.
- B. Always drive carefully—** especially on slippery surfaces. ABS cannot create friction between the tires and the road surface, it can only give the driver the maximum advantage of the existing adhesion. If the vehicle is traveling on a surface with no adhesion, the best ABS in the world cannot provide a shorter stopping distance or good steering.
- C. It is a good idea to practice an ABS activated stop** and get the feel of the brake pedal. However, please make sure it's at a safe time with no obstacles in your path. And you only really need to try it once or twice to know what happens.

ELECTRONIC STABILITY CONTROL SYSTEMS (STABILITRAK)

StabiliTrak systems help drivers maintain control of their vehicles, especially during emergency lane changes or avoidance maneuvers. StabiliTrak uses various sensors, such as steering wheel angle, wheel speed, yaw velocity, etc., to detect any difference between the path requested by the steering wheel position and vehicle's actual path. When appropriate, the system selectively controls brakes, engine power, and even suspension settings to enhance control of the vehicle's direction and help keep it on course. Independent studies conducted by the National Highway Traffic Safety Administration, the Insurance Institute for Highway Safety, and others have found StabiliTrak to be highly effective in reducing vehicle crashes. General Motors offers StabiliTrak systems on many of its passenger car and light truck models. See your owner's manual for additional information about the operation of StabiliTrak.

Q. How do I use StabiliTrak?

A. StabiliTrak operates independently of the driver. You should continue to drive your StabiliTrak equipped vehicle with caution and care. GM's StabiliTrak system, StabiliTrak, is designed to be as seamless as possible in operation, to be part of the overall vehicle response and to make a good vehicle better

Q. How does StabiliTrak work?

A. StabiliTrak has the ability to apply control forces to the vehicle independent of the driver. StabiliTrak uses sensors to continuously compare the path indicated by the steering wheel position to the vehicle's actual path. If a discrepancy is detected, StabiliTrak selectively controls vehicle brakes and engine torque to create a yaw moment that helps restore the vehicle's actual path to the path indicated by the steering wheel position. StabiliTrak has the ability to help correct both understeer (where the vehicle is not turning as much as the steering wheel position indicates) and oversteer (where the vehicle is turning more than the steering wheel position indicates). The illustration at right shows how selective braking at a particular wheel can create a compensating yaw moment to help restore the vehicle's actual path to the path indicated by the steering wheel position.

Q. Will a tire change affect StabiliTrak?

A. Use of tires other than original equipment may affect StabiliTrak performance. StabiliTrak is designed to make the best use of available traction. The performance characteristics of the original equipment tires are part of the overall system effectiveness. When you replace tires check the recommendations in your Owners Manual. On GM vehicles, the original equipment tires have a "TPC" (Tire Performance Criteria) code on the sidewall. Replacing the tires with the same "TPC" code will help assure proper StabiliTrak performance.

UPDATES FOR 2012



NEW FEATURES

- (GAN) Silver Ice Metallic
- (89U) Crystal Red Tintcoat
- (UYS) Audio system with navigation - standard
- Electronic trailer sway control and hill start assist - standard
- (A95) Cloth seats available

Deletions

- (80U) Red Jewel Tintcoat
- (GGZ) Sheer Silver Metallic
- (GGW) Taupe Gray Metallic
- (UUL) Audio system with navigation
- (UUK) Audio system with rear seat entertainment and navigation

2 | TAHOE HYBRID MUNICIPAL PACKAGE – 1HY

Note: This vehicle is NOT designed nor intended for use IN HIGH SPEED EMERGENCY VEHICLE OPERATIONS

MODEL AVAILABILITY

CC10706	2-wheel drive, 8 passenger full-size SUV
CK10706	4-wheel drive, 8 passenger full-size SUV

STANDARD EQUIPMENT SUMMARY

WARRANTY	3 years / 36,000 mile bumper-to-bumper (whichever comes first, see dealer for details) 8 years / 100,000 mile limited powertrain (whichever comes first, see dealer for details)
----------	---

INTERIOR FEATURES

AIR CONDITIONING	Tri-zone manual climate control with individual climate settings for driver and front passenger; includes auxiliary rear air conditioning and heat (rear air operated from front control only)
ASSIST HANDLES	Front passenger and second row outboard
AUDIO SYSTEM	Audio system with navigation AM/FM stereo with CD player, 7-inch touch screen Color Interface Display (CID), 80 GB hard drive, with navigation ¹³ and voice recognition, USB port, MP3 playback capability, Radio Data System (RDS), speed compensation volume, time shift recording capability
AUDIO SYSTEM CONTROLS	Rear with 2 headphone jacks (headphones not included), power outlet and controls for volume, station selection and media
BLUETOOTH FOR PHONE ¹⁰	Personal cell phone connectivity to vehicle audio system and HMI (Human Machine Interface), with specific steering wheel controls
CAMERA SYSTEM	Rearview
CONSOLE	Floor with storage area, cup holders and integrated second row audio controls
CRUISE CONTROL	Electronic with set and resume speed
CUP HOLDERS	In front seating area, in rear of floor console and in second row seat, driver and passenger side in third row side trim
DOMELAMPS	Interior with dome lamp, driver and passenger side door switch with delayed entry feature, cargo lamps, door handle or remote keyless entry-activated illuminated entry and map lamps in front and second seat positions
FLOOR COVERING	Color-keyed carpeted first and second row, removable
GLASS	Solar-Ray deep tinted (all windows except light-tinted glass on windshield, driver and front passenger side glass)
HEATER	Rear auxiliary with rear passenger heating ducts
MIRROR	Inside rearview auto-dimming
ONSTAR ⁸	1-year of Directions and Connections plan. Includes Automatic Crash Response, Emergency Services, Crisis Assist, Stolen Vehicle Assistance featuring Stolen Vehicle Slowdown, Remote Door Unlock, Roadside Assistance, Remote Horn and Lamps, innovative easy to use Turn-by-Turn Navigation with Destination Download and OnStar eNav (where available), available Hands Free Calling, OnStar Vehicle Diagnostics, and Low Mileage Discount
PEDALS	Power-adjustable
REMOTE VEHICLE STARTER	Includes remote keyless entry
RESTRAINT SYSTEM	Safety belts, driver and front passenger with pretensioners, dual stage driver and passenger frontal air bags ¹ , passenger sensing system and frontal air bag ¹ ON/OFF indicator, rollover sensor, dual head curtain air bags ¹ for front and rear outboard occupants and front seat back mounted thorax-pelvic air bags ¹
SEAT, FRONT	Front bucket with leather-appointed seating, 6-way power driver and front passenger seat adjusters, driver manual lumbar control, adjustable head restraints, floor console and rear storage pockets
SEAT, REAR	Second row 60/40 split-folding bench, 3-passenger with center armrest with 2 cup holders
SEAT, THIRD ROW	50/50 split-bench with vinyl, 3-passenger, removable, all-belts-to-seat
SPEEDOMETER/CLUSTER	Analog with speedometer, odometer with trip odometer, fuel level, economy gauge, engine temperature, oil pressure and tachometer
STEERING WHEEL	Tilt-wheel with column mounted gear shift lever, audio and cruise controls

1. Head curtain side air bags are designed to help reduce the risk of head and neck injuries to front and rear seat occupants on the near side of certain side-impact collisions.

Always use safety belts and the correct child restraints for your child's age and size, even in vehicles equipped with air bags. Children are safer when properly secured in a rear seat. See your vehicle Owner's Manual and child safety seat instructions for more information.

8. Visit OnStar.com for coverage map, system limitations and details.

9. XM Radio requires a subscription, sold separately by XM after the trial period. Not available in Canada, Alaska or Hawaii. For more information, visit gm.xmradio.com.

10. Go to gm.com/bluetooth to find out which Bluetooth phones are compatible with the vehicle.

13. Navigation Systems — map coverage includes only the 48 contiguous United States and portions of Hawaii and Canada. Not available in Alaska, Puerto Rico or the Virgin Islands.

INTERIOR FEATURES (CONTINUED)

THEFT DETERRENT	Vehicle theft PASS-Key® III+ and content theft (unauthorized entry sounds horn and lamps flash)
UNIVERSAL HOME REMOTE VISORS	Includes garage door opener, programmable
WARNING TONES	Padded with cloth trim, extends on rod; driver and front passenger illuminated vanity mirrors
WINDOW OPERATION	Headlamp on, key-in-ignition, driver and right-front passenger safety belt unfasten and turn signal on
	Power with driver express-down and lockout features

ELECTRICAL FEATURES

HIGH VOLTAGE MANAGEMENT	Power electronics module
HYBRID PROPULSION	300-volt Energy Storage System
POWER DISTRIBUTION	An optional power distribution system can be integrated into the vehicle 12-volt electrical system at the front compartment RPO WJR or front compartment and rear cargo area RPO WJK. All aftermarket electrical equipment and accessories must be wired to the fused circuits provided in the upfitter 12-volt power distribution panels. The total amount of power available to the panel(s) is 45-amps 540-watts. The power distribution system simplifies upfitting and avoids connection to critical components of the hybrid vehicle electrical system. See Upfitter integration bulletin #89re for details (to access bulletin go to GMUpfitter.com, click on the Technical Bulletins, choose the Model Year (2011), Vehicle Platform (C/K) and Type (SUV), then All Bulletins... Scroll to 89re .)
POWER OUTLET	3-prong household-style, 115-volt, 150-watt, located in rear interior quarter trim
POWER OUTLETS	Five auxiliary, 12-volt, includes two on the instrument panel, one in the cargo area, one inside the center console and one at the back of the console

EXTERIOR FEATURES

ASSIST STEPS	Black, mounted between front and rear wheels
BODY SIDE MOLDINGS	Color - keyed
DEFOGGER	Electric, rear window
DOOR HANDLES	Color - keyed
DOOR LOCKS	Power, programmable with lockout protection, and automatic door locking and unlocking, door lock cylinder no longer available on passenger front door and rear liftgate, child safety locks included in rear doors
FASCIA, FRONT	Color - keyed, unique hybrid design
FASCIA, REAR	Color - keyed, unique hybrid design
HEADLAMPS	Dual halogen composite with flash-to-pass feature, automatic exterior lamp control and daytime running lamps
KEYLESS ENTRY	Remote keyless entry and remote vehicle starter system
MIRRORS	Outside heated power-adjustable, power-folding and driver side auto-dimming, color-keyed, with integrated turn signal indicators, ground illumination and curb-tilt
REAR LIFTGATE	Fixed glass and rear-window wiper/washer
REAR PARKING ASSIST	Ultrasonic with audible warning
WIPER	Rear intermittent with washer
WINDSHIELD WIPERS	Front intermittent wet-arm with flat blade and pulse washers

CHASSIS FEATURES

AIR CLEANER	High-capacity
AXLE	3:08 axle ratio with limited slip
BATTERY	Heavy-duty 730 cca, maintenance-free with rundown protection and retained accessory power, hybrid 300-volt energy storage system located under the 2nd row seat cushion
BRAKES	4-wheel antilock, 4-wheel disc, electro-hydraulic power, regenerative system with StabiliTrak
COOLING	Electric fans and extended life coolant; coolant hoses are EPDM (ethylene-propylene-diene monomer) rubber
DIFFERENTIAL	Heavy-duty locking rear
ENGINE	Vortec 6.0L V8 SFI, LIVC with active fuel management
FRAME	Full perimeter modular with hydroformed frame rails
FUEL TANK CAPACITY	26 gallon (98 liters)
OIL COOLERS	Engine and transmission auxiliary air-to-oil and power steering
REGENERATIVE BRAKING	Uses the hybrid propulsion motors in the transmission acting as a generator to decelerate the vehicle by applying resistance while capturing the energy as electricity in the 300V Energy Storage System, which is then available for the next acceleration cycle
SPARK PLUGS	Extended life - iridium tip
STABILITRAK	Stability enhancement system. It is an advanced computer controlled system that assists the driver with directional control of the vehicle in difficult driving conditions. Each time the vehicle is started, the StabiliTrak system is fully on. StabiliTrak can be controlled by a StabiliTrak button on the instrument panel. The condition of the system is displayed by an instrument panel StabiliTrak indicator light and Driver Information Center (DIC) Messages. Push once, Traction Control is off, push and hold five seconds Traction Control and StabiliTrak is off, push again and Traction Control and StabiliTrak are turned back on
STEERING	Power, electric, 42-volt
SUSPENSION, FRONT	Coil-over-shock with stabilizer bar
SUSPENSION, REAR	Multi-link with coil springs with stabilizer bar
TIRES	P265/65R18 all-season, blackwall
TIRE PRESSURE MONITOR	CHECK TIRE PRESSURE (no spare tire sensor)
TIRE, SPARE	Full-size spare, lockable with outside winch-type carrier mounted under frame at rear
TRAILERING EQUIPMENT	Heavy-duty, includes trailering hitch platform, 7-wire harness with independent fused trailering circuits mated to a 7-way sealed connector and (VR4) 2" trailering receiver. Electronic trailer sway control and hill start assist
TRANSFER CASE (4WD)	Active, 2-speed electronic AutoTrac with rotary controls, includes neutral position for dinghy towing
TRANSMISSION	2-mode strong hybrid, automatic, electronic
WHEELS	18" x 8" aluminum

POWERTRAIN

ENGINE				TRANSMISSION		AXLE		GVWR	
OPTION CODE	TYPE	DISPLACEMENT LITERS/CU. IN.	FUEL SYSTEM	OPTION CODE	TYPE	OPTION CODE	RATIO	2WD	4WD
LZ1	V8	6.0/364	Active fuel management	M99	2-mode strong hybrid automatic electronic	GU4	3.08	C5Y 7100 (3221)	C6A 7300 (3311)
						G80	Locking Differential		

EMISSIONS - MUST BE SPECIFIED

FE9	FEDERAL EMISSIONS. Use for ordering vehicles that will be registered in all states except California, Connecticut, Maine, Maryland, Massachusetts, New Jersey, New Mexico, New York, Oregon, Pennsylvania, Rhode Island, Vermont and Washington State
YF5	CALIFORNIA EMISSIONS. Use for ordering vehicles that will be registered in California.
NE1	CT/ME/MD/MA/NJ/NM/NY/OR/PA/RI/VT/WA EMISSIONS. Use for ordering vehicles that will be registered in Connecticut, Maine, Maryland, Massachusetts, New Jersey, New Mexico, New York, Oregon, Pennsylvania, Rhode Island, Vermont or Washington State
NB8	Required when option code FE9 "FEDERAL EMISSIONS" is ordered for delivery to a dealer located in California, Connecticut, Massachusetts, Maryland, New Jersey, New Mexico, New York, Oregon, Pennsylvania, Rhode Island and Washington State for a purchaser who will be registering the vehicle outside California, Connecticut, Maine, Maryland, Massachusetts, New Jersey, New Mexico, New York, Oregon, Pennsylvania, Rhode Island, Vermont and Washington State.
NC7	Required when option code YF5 "CALIFORNIA EMISSIONS" or option code NE1 "CT/ME/MD/MA/NJ/NM/NY/OR/PA/RI/VT/WA EMISSIONS" is ordered for delivery to a dealer located in any state except California, Connecticut, Maine, Maryland, Massachusetts, New Jersey, New Mexico, New York, Oregon, Pennsylvania, Rhode Island, Vermont and Washington for a purchaser who will be registering the vehicle in one of these states or sold as permitted below under "EPA Policy on the Sale of California Emission Vehicles"
NB9	Required when option code YF5 is ordered for delivery to a dealer located in Connecticut, Maine, Maryland, Massachusetts, New Jersey, New Mexico, New York, Oregon, Pennsylvania, Rhode Island, Vermont and Washington. Required when option code NE1 is ordered for delivery to a dealer located in California.







TIRES

CODE	QUANTITY	SIZE	SPEED RATING	TYPE
QXK	5	P265/65R18	S	All season BW

SEATS AND INTERIOR TRIM

	SEAT OPTIONS	EBONY	LIGHT TITANIUM	LIGHT CASHMERE
STANDARD Front: Leather high-back reclining bucket, 6-way power seat adjusters Rear: Leather	A95	193	833	333
OPTIONAL Front: Cloth high-back reclining bucket, 6-way power seat adjusters Rear: Cloth	A95	19C	–	–

AVAILABLE EXTERIOR COLORS

 58U	 GAN	 41U	 50U	 89U	 GHA
*Black Granite Metallic	Silver Ice Metallic	Black	Summit White	*Crystal Red Tintcoat	Mocha Steel Metallic
Actual colors may vary * Extra Cost					

AVAILABLE OPTIONS WITH TAHOE HYBRID MUNICIPAL PACKAGE – 1HY

R8G	CUMULATIVE SECOND YEAR OF ONSTAR® SAFE AND SOUND SERVICE - In addition to the first year of Directions and Connections Service that is included in the price of the vehicle. Fleet may also order RFA OnStar Business Vehicle Manager Service (requires UE1 OnStar 1-year Directions and Connections plan. Requires one of the following Fleet or Government order types: FLS, FNR, FRC, FBC, FGO or FEF. Not available with R8P, R8Y, R8Z, RFG or RFH)
R8P	CUMULATIVE SECOND AND THIRD YEAR OF ONSTAR® SAFE AND SOUND SERVICE - In addition to the first year of Directions and Connections Service that is included in the price of the vehicle. Fleet may also order RFA OnStar Business Vehicle Manager Service (requires UE1 OnStar 1-year Directions and Connections plan. Requires one of the following Fleet or Government order types: FLS, FNR, FRC, FBC, FGO or FEF. Not available with R8G, R8Y, R8Z, RFG or RFH)
U42	ENTERTAINMENT SYSTEM - Rear seat DVD player with remote control, overhead display, two sets of 2-channel wireless infrared headphones and auxiliary audio/video input jacks, included and only available with PCJ Sun, Entertainment and Destinations Package
VKY	HANDLES CHROME DOOR - (LPO dealer installed)
VK3	LICENSE PLATE BRACKET - Front (will be forced orders that require front license plate)
VLI	MAT REAR CARGO - (LPO dealer installed)
VAV	MATS ALL-WEATHER FLOOR - First and second row (LPO dealer installed)
VKN	MATS ALL-WEATHER FLOOR - Third row (LPO dealer installed)
VKU	MIRROR CHROME CAPS - (LPO dealer installed)
R8Y	ONSTAR® 1 ADDITIONAL YEAR OF DIRECTIONS AND CONNECTIONS SERVICE - Provides 1 additional Year of Directions and Connections Service following the first year of OnStar service included in the price of the vehicle. Fleet may also order RFA OnStar Business Vehicle Manager Service (requires UE1 OnStar 1-year Directions and Connections plan. Requires one of the following Fleet or Government order types: FLS, FNR, FRC, FBC, FGO or FEF. Not available with R8G, R8P, R8Z, RFG or RFH)
R8Z	ONSTAR® 2 ADDITIONAL YEARS DIRECTIONS AND CONNECTIONS SERVICE - Provides 2 additional Years of Directions and Connections service following the first year of OnStar service included in the price of the vehicle. Fleet may also order (RFA) OnStar Business Vehicle Manager Service (requires UE1 OnStar 1-year Directions and Connections plan. Requires one of the following Fleet or Government order types: FLS, FNR, FRC, FBC, FGO or FEF. Not available with R8G, R8P, R8Y, RFG or RFH)
RFG	ONSTAR® 3 ADDITIONAL YEARS SAFE AND SOUND SERVICE - Provides 3 additional Years of Safe and Sound service following the first year of OnStar service included in the price of the vehicle. Fleet may also order (RFA) OnStar Business Vehicle Manager Service (requires UE1 OnStar 1-year Directions and Connections plan. Requires one of the following Fleet or Government order types: FLS, FNR, FRC, FBC, FGO or FEF. Not available with R8G, R8P, R8Y, R8Z or RFH)
RFH	ONSTAR® 4 ADDITIONAL YEARS SAFE AND SOUND SERVICE - Provides 4 additional Years of Safe and Sound service following the first year of OnStar service included in the price of the vehicle. Fleet may also order (RFA) OnStar Business Vehicle Manager Service (requires UE1 OnStar 1-year Directions and Connections plan. Requires one of the following Fleet or Government order types: FLS, FNR, FRC, FBC, FGO or FEF. Not available with R8G, R8P, R8Y, R8Z or RFG)
RFA	ONSTAR® BUSINESS VEHICLE MANAGER SERVICE - Provides OnStar Business Vehicle Manager Service equal to the length of OnStar service (requires one of the following Fleet or Government order types: FLS, FNR, FRC, FBC, FGO or FEF. Requires Fleet Master Agreement)
VKW	ORGANIZER FRONT CONSOLE - (LPO dealer installed)
WRJ	POWER DISTRIBUTION CENTER, DUAL - Integrated in to the electrical system located in the drivers compartment and the cargo area
WRK	POWER DISTRIBUTION CENTER, SINGLE - Integrated into the electrical system located in the drivers compartment area.
PCJ	SUN, ENTERTAINMENT AND DESTINATIONS PACKAGE - Includes 1 year of XM Radio ⁹ and XM NavTraffic service, CF5 power sunroof, UUK AM/FM stereo with MP3 compatible CD/DVD player and DVD-based navigation ¹³ , UVC rearview camera system and U42 rear seat DVD entertainment system
R6X	SUN, ENTERTAINMENT AND DESTINATIONS PACKAGE DISCOUNT NOT DESIRED
CF5	SUNROOF - Power, tilt-sliding with express-open and close and wind deflector
W04	THEFT-DETERRENT WHEEL - Security system that sets off the vehicle alarm system if the vehicle is jacked up or towed, designed to protect 20"/22" SPO upsize wheels (LPO dealer installed)
VKX	TIRE AND WHEEL - Spare (LPO dealer installed)

8. Visit OnStar.com for coverage map, system limitations and details.

9. XM Radio requires a subscription, sold separately by XM after the trial period. Not available in Canada, Alaska or Hawaii. For more information, visit gm.xmradio.com.

13. Navigation Systems — map coverage includes only the 48 contiguous United States and portions of Hawaii and Canada. Not available in Alaska, Puerto Rico or the Virgin Islands.

TAHOE HYBRID MUNICIPAL PACKAGE 1HY – SPECIFICATIONS | 7

GENERAL

Model	2-wheel	CC10706
Model	4-wheel	CK10706

EXTERIOR (in./mm)

Wheelbase	116/2946
Overall length	202.0/5131
Overall width	79.0/2007
Overall height, 2-wheel	74.61/1895
Overall height, 4-wheel	74.84/1901
Front track width	68.2/1732
Rear track width	67.0/1701
Turning diameter curb to curb (ft./m)	39.0/11.9
Ground clearance, 2-wheel (front)	10.19/259
Ground clearance, 2-wheel (rear)	9.53/242
Ground clearance, 4-wheel (front)	10.19/259
Ground clearance, 4-wheel (rear)	9.84/250

FRONT COMPARTMENT (in./mm)

Head room	41.1/1044
Shoulder room	65.3/1659
Hip room	60.5/1537
Leg room (maximum)	41.3/1049

2nd SEAT (in./mm)

Head room	34.10/866
Shoulder room	65.2/1656
Hip room	60.6/1539
Leg room (minimum)	39.0/991

3rd SEAT (in./mm)

Head room	37.90/963
Shoulder room	61.70/1567
Hip room	49.10/1247
Leg room (minimum)	25.60/650

CARGO (cu.ft./liters)

Cargo volume behind front seat ³	108.9/3084
Cargo volume behind second seat ³	60.3/1707.7
Cargo volume behind third seat ³	16.9/478.6
Load floor length to center 2nd seat at floor (in./mm)	49.4/1255
Load floor length to front seat at floor (in./mm)	81.4/2068
Load floor length to rear seat at floor (in./mm)	15.2/386
Ground to top of rear load floor, 2-wheel (in./mm)	32.28/820
Ground to top of rear load floor, 4-wheel (in./mm)	32.68/830
Inside width between wheel house (in./mm)	49.1/1247
Cargo area height (in./mm)	41.7/1059

Note: For additional dimensional data go to: gmupfitter.com

PASSENGER COMPARTMENT VOLUME INDEX (cu.ft./liters)

Passenger compartment volume	121.8/3449
------------------------------	------------

FUEL ECONOMY RATINGS CITY/HIGHWAY/COMBINED

6.0L ⁴	20/23/21
-------------------	----------

Projected EPA label values, actual mileage will vary with options, driving conditions, driving habits and vehicles condition.

3. Cargo and load capacity limited by weight and distribution.

4. EPA-estimated MPG.

5. Gross Vehicle Weight Rating (GVWR). When properly equipped, includes vehicle, passengers, cargo and equipment.

6. Maximum payload capacity includes weight of driver, passengers, optional equipment and cargo.

ENGINE

Type	SFI
Displacement: liters/cu. in.	6.0/364
Horsepower/rpm	332 @ 5100
Torque lb.-ft./rpm	367 @ 4100
Induction system	SFI
Compression ratio	10.78:1
Exhaust	Single
Minimum recommended fuel octane	87
Fuel tank capacity (gallons/liters)	24/91

TRANSMISSION

Automatic electronic with overdrive	2-mode hybrid
-------------------------------------	---------------

AXLE

Ratio 4-wheel drive	3.08
---------------------	------

BRAKES

ABS with vacuum boost	Disc/Disc
Front - swept area (sq. in./sq. cm)	256.6/1655
Rear - swept area (sq. in./sq. cm)	248/1600
Total front and rear swept area (sq. in./sq. cm)	504.6/3255
Front rotor diameter (in./mm)	13.0/330
Rear rotor diameter (in./mm)	13.5/343
Front rotor thickness (in./mm)	1.2/30
Rear rotor thickness (in./mm)	.79/20

TIRES

Type	All-season
Size	P265/65R18

WHEELS

Type	Aluminum
Size	18" x 8"

CHASSIS

Frame	Full perimeter steel
Front suspension	Independent, single coil-over-shock with stabilizer bar
Rear suspension	Multi-link with coil spring
Steering type	Power rack and pinion

BATTERY

Type	Maintenance free
BCI group size	LN3
Volts	12
Amp hour rating	80
Cold cranking amps @ 0°F (-18°C)	730
Reserve capacity @ 80°F (27°C)	110

VEHICLE WEIGHT (lbs./kg.)

	2WD	4WD
GVWR 4-wheel drive ⁵	7100/3221	7300/3311
Curb	5629/2553	5907/2679
Payload ⁶ with 40/20/40 split-bench seat	1476/670	1393/632

Note: See owner's manual supplement for loading information

Can specialty vehicle equipment (e.g. radar devices, video cameras, computers, meters, radio trees, shotguns, etc.) still be mounted in cars with passenger side air bags?

Yes, but care must be taken to mount the equipment outside of the deployment zone. Air bags inflate with great force and will interact with any object in the deployment zone. Therefore, to reduce the risk of injury to vehicle occupants, GM recommends that the air deployment zone be kept free of any equipment. If a piece of equipment were to become dislodged it could strike an occupant in the vehicle and result in injury. The likelihood of an object becoming dislodged is influenced by many factors, including the proximity of the object to the inflatable restraint, the size and shape of the object, and the means by which the object is secured to the vehicle. In addition to these factors, the trajectory and velocity of a dislodged object can be influenced by the type and severity of vehicle crash.

Objects that are in the deployment zone, but do not become dislodged by an inflating air bag can still affect the performance of the air bag. For example, such objects could tear the fabric or affect the shape of the air bag, thus reducing the ability of the bag to provide restraint.

Is it possible to shield equipment that is installed in the passenger side frontal air bag deployment zone in a manner that will allow full and safe air bag deployment?

Due to the complexity of influencing variables, GM is unable to evaluate the potential for shielding expected equipment configurations in all accident scenarios in order to assure that the air bag performance would be unaffected. While shielding may protect certain equipment from being damaged or dislodged, it may also negatively affect the inflation characteristics of the air bag. The air bag's shape, inflation angle, fold pattern, and inflation rate and pressure are developed to maximize the protection capability of the inflatable restraint system. Therefore, GM cannot recommend the placement of any equipment in the deployment zone, even if it is shielded to protect it from damage.

Front air bag systems and instrument panel mounted equipment.

Passenger air bags in GM vehicles deploy in different ways depending upon the type of vehicle and the particular instrument panel design.

In some vehicles, the passenger air bag deploys through a discrete door located on the top surface of the instrument panel (top-mount air bag systems). In other vehicles, such as the Chevrolet Tahoe, the passenger air bag deploys through a discrete door mounted on the vertical rearward surface of the instrument panel, above the glove box door (mid-mount air bag system). With these types of top-mount and mid-mount passenger air bag systems, the top pad of the instrument panel remains in place during deployment.

Some GM passenger air bag systems, like the system in the Chevrolet Impala, deploy from beneath the instrument panel top pad. These are considered 3/4-mount air bag systems with a "deployable top pad." The entire instrument panel top pad is the "deployment door" from under which the inflating air bag emerges. When an air bag deployment is commanded, the forces from the inflating passenger air bag push up on the instrument panel top pad, releasing special fasteners across the rearward edge of the top pad. This allows the top pad to rotate upward so that the passenger air bag may emerge. The top pad rotates upward to open widest at the right hand side, and is usually forced upward into contact with the windshield on the right hand side of the vehicle during a deployment.

Head curtain side air bags are designed to help reduce the risk of head and neck injuries to front and rear seat occupants on the near side of certain side-impact collisions. Always use safety belts and the correct child restraints for your child's age and size, even in vehicles equipped with air bags. Children are safer when properly secured in a rear seat. See your vehicle Owner's Manual and child safety seat instructions for more information.

Instrument panel top mounted special equipment, such as a radar antenna and control unit or video camera must be positioned to the left of the vehicle center line. This equipment must be mounted as low as possible and securely fastened to the top pad to avoid being dislodged in the event of a crash and possible air bag deployment. In the process of securely fastening special equipment to the top, DO NOT fasten down the top pad itself to any other vehicle component such as the cluster trim plate. As described above, the top pad rotates upward during a deployment. In order to enable the proper deployment of the passenger air bag, specialty equipment installation MUST NOT PREVENT the top pad from rotating upward during deployment. Location and attachment of special equipment should minimize added resistance or interference to upward rotation of the top pad during deployment.

Optional side air bags for crashes to the vehicle sides.

The air bag system in your police vehicle may include optional side air bags for front and rear occupants. Most front-to-rear side air bags are designed to deploy downward from the interior roof sides to the bottom of the door windows.

Can Specialty Vehicle Security Barriers be mounted within the side air bag deployment zones?

No. The side air bags inflate extremely fast because of the nature of side crashes to the vehicle. Mounting a security barrier behind the front seats with the ends placed within the side air bag deployment zones will result in unintended interaction between the barrier and the inflating side air bags. To reduce the risk of injury to the vehicle occupants, GM recommends that the side air bag zones be kept free of any customer installed equipment.

Customer furnished equipment installed to the vehicle roof.

Your police vehicle is designed with an interior roof cover system which includes internal components for the interior lamps and wiring. The roof system may also include optional side air bag components. Inflation devices may be mounted on the vehicle roof side behind the rear doors as well as air bag tethers retained to the windshield pillars. Care must be taken to avoid damage to these components or interference with their operation when installing roof mounted equipment such as emergency lamps and communication antennas.

Recommended GM service procedures must be followed to remove and re-install the instrument panel top pad to ensure that the top pad will release properly in the event of a passenger air bag deployment.

On the right half of the top pad closest to the passenger air bag module, GM recommends that no equipment be mounted. When mounting equipment on the driver side of the top pad, GM recommends that the total mass of the top pad mounted special equipment not exceed 8 pounds (3.6 kilograms), since the top pad tends to rotate about the left end.

Fasteners used to secure special equipment to the instrument panel top pad, the windshield glass, or to the windshield upper frame (header), should be selected to ensure that these devices will remain attached during a vehicle crash and possible air bag deployment.

Can the installation of push bumpers on the front end of the vehicle affect the deployment of the air bag?

General Motors is not aware of adverse effects during crash events from the many push bumpers that have been installed on GM police vehicles. Because there are many styles of push bumpers available with varying crash characteristics, installation of push bumpers may or may not affect deployment timing of the air bags. Push bumpers should be mounted to avoid modifying the vehicle structure and interfering with the front air bag sensors mounted on the upper radiator support cross member.

Two front impact sensors are installed in General Motors vehicles. Do not relocate or disconnect the front sensors. The location and orientation of the front sensors are critical for correct operation of the air bag system. Avoid mounting components on or near the sensors. Push bumper styles with vertical pushing members that are in fore-aft alignment with the front air bag sensors are not recommended.

How long will the air bag remain inflated?

It takes approximately 1/20th of a second to fully inflate the frontal air bags. This is faster than the blink of an eye. The air bags begin to deflate immediately, helping to stop the occupants more gradually.

Can the air bag system be re-used?

No. The air bags are designed to inflate only once. After inflation some new parts will be required. These will include the air bag module and possibly other parts. (A competent service technician with access to the vehicle's service manual and the required tools should replace the required components after a deployment crash.)

I've heard that the dusts that are released into the passenger compartment from the air bag are harmful. Is this true?

For most people, the only effect the dusts will produce is some irritation of the throat and eyes, and that is only if the occupant remains in the vehicle for many minutes after the air bag deployment with no ventilation and windows closed. However, some people with asthma may develop an asthmatic attack from inhaling the dusts. If this happens, they should first treat themselves the same way their doctor has advised them to treat any other asthma attack, and then immediately seek medical treatment.

When should an air bag inflate?

The driver's and right-front passenger's frontal air bags are designed to inflate in moderate to severe frontal or near-frontal crashes. But they are designed to inflate only if the impact speed is above the system's designed "threshold level."

In addition, if your vehicle has "dual stage" frontal air bags, these air bags tailor the amount of restraint according to crash severity. For moderate frontal impacts, the air bags inflate at a level less than full deployment. For more severe frontal impacts, "dual stage" frontal air bags deploy at full levels.

If the front of your vehicle goes straight into a wall that doesn't move or deform, the threshold level of the reduced deployment is about 12 to 16 mph (19 to 15 km/h), and the threshold level for a full deployment is about 18 to 24 mph (29 to 28.5 km/h). The threshold level can vary, however, with specific vehicle design, so that it can be somewhat above or below this range.

If your vehicle strikes something that will move or deform such as a parked car, the threshold level will be higher. The driver's and right-front passenger's frontal air bags are not designed to inflate in rollover, side impacts, or rear impacts, because inflation would not help the occupant.

Head curtain side air bags are designed to help reduce the risk of head and neck injuries to front and rear seat occupants on the near side of certain side-impact collisions. Always use safety belts and the correct child restraints for your child's age and size, even in vehicles equipped with air bags. Children are safer when properly secured in a rear seat. See your vehicle Owner's Manual and child safety seat instructions for more information.

Seat mounted side impact air bags are designed to inflate in moderate to severe side crashes. The side impact air bags will inflate if the crash severity is above the designed "threshold level." The threshold level can vary with specific vehicles design. The side impact air bags are not designed to inflate on frontal or near-frontal impacts or rear impacts, because inflation would not help the occupant.

Roof rail mounted head-curtain air bags are designed to inflate in moderate to severe side crashes. In addition, certain vehicles have head-curtain air bags which are also designed to inflate in situations where an impending rollover condition is identified by the vehicle's rollover sensing system and/or frontal or near-frontal impacts if the crash severity is above the designed "threshold level".

Safety belt pretensioners at the driver and front passenger seat positions are designed to deploy in frontal, near-frontal, side, and rear crashes that exceed the "threshold level" of crash severity to help reduce slack in the safety belt. Safety belt pretensioners will also deploy in impending rollover situations.

I've heard that a deployed air bag produces what appears to be smoke. Is the air bag hot?

After the bag has deployed in a crash, the air bag itself will not be hot to touch. Some components within the air bag module will be hot for a short time. A small amount of smoke coming from a deployed air bag module is normal and should not be cause for concern.

Also, when the nitrogen gas is vented out of the air bag, small particles from inside the bag are also vented into passenger compartment. These airborne particles look like smoke and some particles are deposited as residue on and around the air bag.

If my vehicle has air bags, why should I have to wear my safety belt?

Air bags are in many vehicles today and will be in most of them in the future. But they are supplemental systems only; so they work with safety belts - not instead of them. Every air bag system ever offered for sale has required the use of safety belts. Even if you're in a vehicle that has air bags, you still have to buckle up to get the most protection. That's true not only in frontal collisions but especially in side and other collisions.

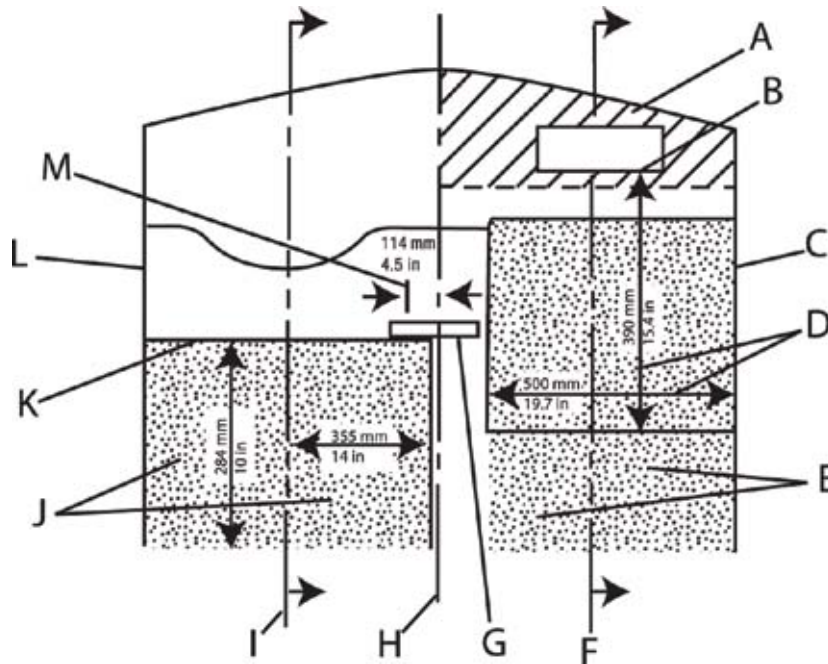

TOP VIEW OF INSTRUMENT PANEL AND APPROXIMATE DEPLOYMENT AREA OF THE AIR BAG ZONE

- A. Passenger side instrument panel top surface zone
- B. Passenger side air bag module trim panel – rear edge
- C. Passenger side door
- D. Approximate dimensions of inflated air bag
- E. Passenger side air bag deployment zone
- F. Passenger centerline
- G. Inside rearview mirror
- H. Vehicle centerline
- I. Driver centerline
- J. Driver side air bag deployment zone
- K. Front of steering wheel
- L. Driver side door
- M. Shift selector arc

Head curtain side air bags are designed to help reduce the risk of head and neck injuries to front and rear seat occupants on the near side of certain side-impact collisions. Always use safety belts and the correct child restraints for your child's age and size, even in vehicles equipped with air bags. Children are safer when properly secured in a rear seat. See your vehicle Owner's Manual and child safety seat instructions for more information.

Note: All dimensions are approximate and subject to change.

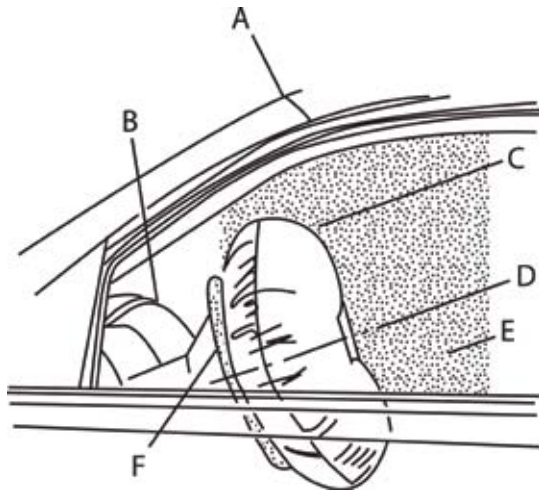

SIDE VIEW OF DRIVER SIDE AIR BAG DEPLOYMENT ZONE

- A. Top edge of windshield
- B. Top of instrument panel
- C. Inflated air bag – steering wheel
- D. Centerline of steering column at mid-tilt
- E. Driver air bag deployment zone
- F. Front of steering wheel

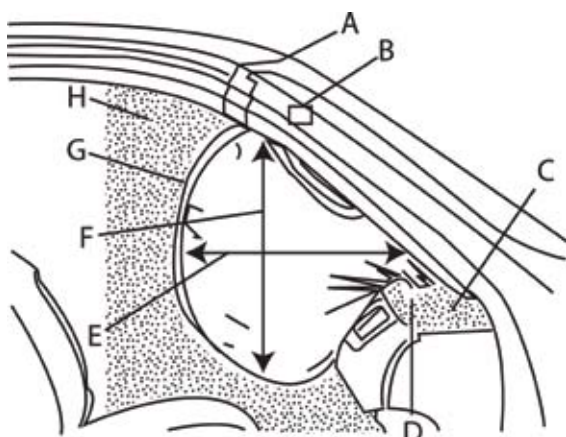

SIDE VIEW OF PASSENGER SIDE AIR BAG DEPLOYMENT ZONE

- A. Top edge of windshield
- B. Inside rearview mirror
- C. Instrument panel top surface zone
- D. Passenger side air bag module trim panel – rear edge
- E. Inflated air bag – horizontal dimension approximate 15.4 in (390 mm)
- F. Inflated air bag – vertical dimension approximate 9.3 in (490 mm)
- G. Inflated air bag – instrument panel
- H. Passenger air bag deployment zone

Head curtain side air bags are designed to help reduce the risk of head and neck injuries to front and rear seat occupants on the near side of certain side-impact collisions. Always use safety belts and the correct child restraints for your child's age and size, even in vehicles equipped with air bags. Children are safer when properly secured in a rear seat. See your vehicle Owner's Manual and child safety seat instructions for more information.

Note: All dimensions are approximate and subject to change.

12 | AIR BAG DIMENSIONS – TAHOE HYBRID 1HY

HEAD CURTAIN AND FRONT SEAT-MOUNTED SIDE IMPACT AIR BAG DEPLOYMENT ZONES
PASSENGER SIDE SHOWN, DRIVER SIDE SIMILAR

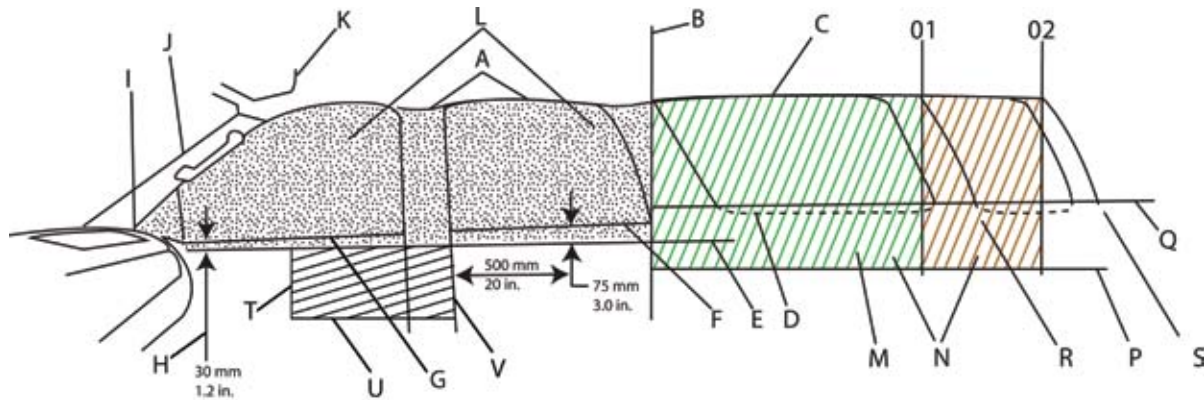

Tahoe/Suburban/Silverado Crew Cab Seat Rows 1 and 2

- A. Top of deployment zone – along head curtain at edge of headliner
- B. Back of deployment zone – at rear top corner of rear door pad
- C. Rear quarter window
- D. Bottom outside edge of rear quarter window
- E. Bottom of air bag deployment zone – parallel to outside bottom edge of rear quarter glass
- F. Top edge of rear door pad
- G. Top edge of front door pad
- H. Dimension at mirror patch from top edge of front door pad
- I. Front of deployment zone at front upper corner of front door pad
- J. Windshield pillar trim with grab handle
- K. Visor
- L. Deployment zone - Tahoe seat rows 1 and 2

Tahoe/Suburban 3rd Row Seats

- M. Deployment zone - Tahoe 3rd seat
- N. Deployment zone - Suburban 3rd seat
- O. Rear zones at back corner of headliner: 1 Tahoe, 2 Suburban
- P. Bottom of 3rd seat zone at rear side trim cup holders
- Q. Top edge of rear quarter trim at window
- R. Rear of Tahoe
- S. Rear of Suburban

Tahoe/Suburban/Silverado Crew Cab Seat Air bag

- T. Center of door trim pull handle
- U. Top of surface of outboard front seat cushion
- V. Back edge of center pillar trim

HEAD CURTAIN AND FRONT SEAT-MOUNTED SIDE IMPACT AIR BAG DEPLOYMENT ZONES
VIEW FROM REAR CARGO AREA

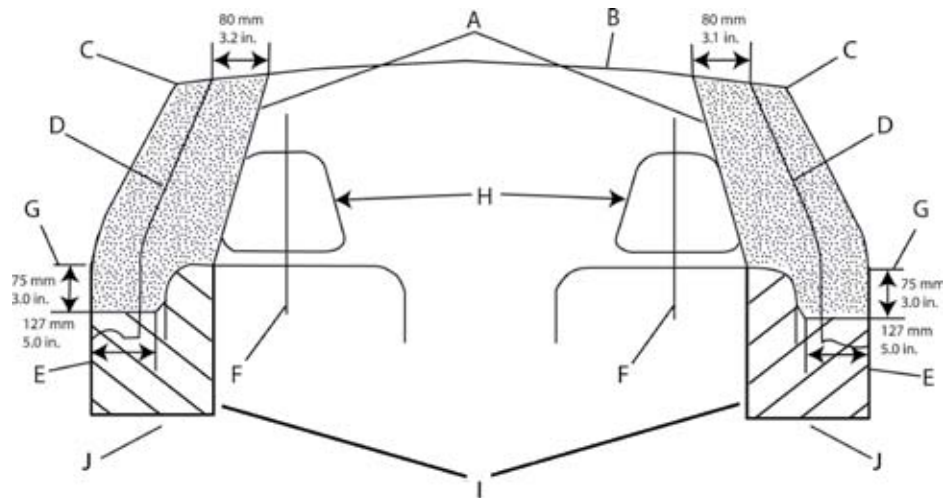

- A. Head curtain air bag deployment zone
- B. Underside of headliner
- C. Edge of headliner
- D. Inner center pillar trim
- E. Inner door pad
- F. Seat centerline
- G. Bottom of door windows
- H. Front seat headrests
- I. Seat-mounted side impact air bags deployment zone front seat
- J. Top surface of outboard front seat cushion

Head curtain side air bags are designed to help reduce the risk of head and neck injuries to front and rear seat occupants on the near side of certain side-impact collisions. Always use safety belts and the correct child restraints for your child's age and size, even in vehicles equipped with air bags. Children are safer when properly secured in a rear seat. See your vehicle Owner's Manual and child safety seat instructions for more information.

Note: All dimensions are approximate and subject to change.

GM offers Anti-Lock Brake Systems as standard or optional on all North American passenger vehicles and light truck lines. The computerized Anti-Lock Braking System (ABS) is designed to keep the vehicle's wheels rotating as the brakes are applied to assist the driver in achieving a controlled stop. Sensors monitor how fast the wheels rotate and feed the data continuously to the ABS computer. The vehicle's brakes slow each wheel as the brake pedal is applied. However, when ABS is activated due to road conditions, the system repeatedly releases and applies pressure to the brakes. The wheels can keep rolling, thus retaining steering ability and enhanced stability while providing a higher braking force on most surfaces than a locked wheel provides.

How exactly does ABS work?

In cars without ABS, hitting the brakes can cause the wheels to lock, leaving you unable to steer the vehicle until you decrease the pressure so the wheels can roll again. With an ABS, as you apply the brakes, the ABS computer monitors the wheel speed sensor information. If the computer senses that a wheel is approaching lock up, it sends a signal to the hydraulic modulator to reduce, then to reapply, brake pressure several times a second for as long as you maintain firm pressure on the brake pedal. The process is much like the threshold braking technique used with conventional brakes. However, ABS does it much faster and more accurately than any driver can, leaving you free to focus on steering away from obstacles.

Does ABS reduce stopping distances?

Yes, in braking situations where the wheels on a non-ABS equipped vehicle would lock up, ABS will generally provide shorter controlled stopping distance. The amount of improvement in stopping distance depends on many factors, including the road surface, severity of braking, initial vehicle speed, etc. On some surfaces, such as gravel roads, braking distances can be longer, but you will still have the control benefits of ABS. The important capability of ABS is control. ABS provides improved vehicle steerability and stability when braking.

What can affect the ABS advantage?

It is important that you follow the maintenance schedule recommended in the owner's manual of the vehicle, tires should be at their proper inflation level, the brake pads should be checked regularly, etc. While driving, you should sit comfortably, so that your hips are back in the seat and your knees are bent, even while braking. Your foot should be positioned so that your heel is on the floor and your toes are secure on the lower half of the pedal. And, though ABS may reduce stopping distance, remember: The faster you go, the longer it takes you to stop. Keeping a safe distance between you and the vehicle in front of you is always necessary, even with ABS.

What happens if ABS becomes inactive?

The ABS electronic control unit has on-board diagnostic capability. If a fault is detected, the vehicle will revert to the base brake system, and the ABS telltale on the dash will be illuminated. Should this happen, the vehicle should be taken to a dealership for repair as soon as possible.

How do I use ABS?

Depress and hold the pedal. DO NOT PUMP THE BRAKES (that prevents the system from working). Just hold the brake pedal down and let the ABS work for you. You may feel the brake pedal vibrate, or you may notice some noise, but this is normal as the system works for you.

Should I drive an ABS equipped vehicle differently than I would drive a vehicle with conventional brakes?

Most of the time, under normal driving circumstances, there is no difference, and you should always drive with the same caution and care. It is important to realize that ABS only makes a difference when it is activated—when you have to brake hard—and that would only be when the computer senses that a wheel is approaching lock up. When ABS activates keep steady pressure on the brake pedal and then let the ABS work for you. Don't pump the brakes or try to find the threshold. Simply hold the brake pedal down and steer if necessary to avoid an obstacle.

Is ABS always active?

ABS is always available, but not always activated. ABS is activated only when the brake pedal is applied and the computer detects an impending wheel lock condition.

Can older cars be retrofitted with ABS?

No! The brake system is one of the most important features on any passenger vehicle. Several products, which tap into the master cylinder and/or brake system performance, are being sold in the aftermarket. Some of these products imply performance similar to new vehicle anti-lock brake systems.

However, contrary to their claims, add-on systems, which deplete fluid from the master cylinder on brake apply may actually increase a vehicle's stopping distance. This may cause the vehicle to fail to comply with Federal brake standards.

Does ABS always activate at the same speed?

No, the system operates when the computer detects wheel lockup, at any speed above 8 mph.

Will ABS wear out a vehicle's brakes sooner?

A properly maintained brake system will be unaffected by ABS operation under typical driving conditions.

Are there different types of ABS?

Yes, there are rear wheel anti-lock systems (RWAL) used on some trucks and four-wheel ABS available on cars and trucks.

Do Federal Safety Standards mandate ABS?

No. Federal standards establish minimum braking performance requirements that all vehicles must meet, but do not specify how they should be met. It should be noted that even a vehicle with failed ABS meets the Federal safety standard for stopping distances.

Will a tire size change affect ABS?

Use of tires other than original equipment may affect ABS performance. Owners should consult and follow the recommendations contained in the vehicle owner's manual regarding replacement tire size. *Note: ABS will work with original equipment spare tire or tire chains. However, performance is reduced.*

Do insurance companies give a discount for ABS?

Yes, many insurance companies give discounts that range from 5% to 10%. In the states of New York and Florida all insurance companies are required to give an ABS discount of 5% on certain coverages such as bodily injury, property damage, collision, and personal injury protection. In other states the discount varies from insurance company to insurance company. When buying auto insurance, always ask your insurance agent if his/her company gives a discount for vehicles equipped with anti-lock brakes.



IMPORTANT DRIVING SAFETY TIPS



- A. Always maintain a safe following distance.** ABS does not allow you to stop on a dime. (Generally a 2-second following distance is considered safe in ideal conditions.) Watch the vehicle in front of you pass a fixed marker (such as a sign). Count seconds—one-thousand-one, one-thousand-two—until your front bumper reaches the marker. If you do not count out two seconds, then you are too close to the vehicle in front of you. Also, if the roads are wet or icy, or visibility is poor, you should increase your following distance.
- B. Always drive carefully—** especially on slippery surfaces. ABS cannot create friction between the tires and the road surface, it can only give the driver the maximum advantage of the existing adhesion. If the vehicle is traveling on a surface with no adhesion, the best ABS in the world cannot provide a shorter stopping distance or good steering.
- C. It is a good idea to practice an ABS activated stop** and get the feel of the brake pedal. However, please make sure it's at a safe time with no obstacles in your path. And you only really need to try it once or twice to know what happens.

ELECTRONIC STABILITY CONTROL SYSTEMS (STABILITRAK)

StabiliTrak systems help drivers maintain control of their vehicles, especially during emergency lane changes or avoidance maneuvers. StabiliTrak uses various sensors, such as steering wheel angle, wheel speed, yaw velocity, etc., to detect any difference between the path requested by the steering wheel position and vehicle's actual path. When appropriate, the system selectively controls brakes, engine power, and even suspension settings to enhance control of the vehicle's direction and help keep it on course. Independent studies conducted by the National Highway Traffic Safety Administration, the Insurance Institute for Highway Safety, and others have found StabiliTrak to be highly effective in reducing vehicle crashes. General Motors offers StabiliTrak systems on many of its passenger car and light truck models. See your owner's manual for additional information about the operation of StabiliTrak.

Q. How do I use StabiliTrak?

A. StabiliTrak operates independently of the driver. You should continue to drive your StabiliTrak equipped vehicle with caution and care. GM's StabiliTrak system, StabiliTrak, is designed to be as seamless as possible in operation, to be part of the overall vehicle response and to make a good vehicle better

Q. How does StabiliTrak work?

A. StabiliTrak has the ability to apply control forces to the vehicle independent of the driver. StabiliTrak uses sensors to continuously compare the path indicated by the steering wheel position to the vehicle's actual path. If a discrepancy is detected, StabiliTrak selectively controls vehicle brakes and engine torque to create a yaw moment that helps restore the vehicle's actual path to the path indicated by the steering wheel position. StabiliTrak has the ability to help correct both understeer (where the vehicle is not turning as much as the steering wheel position indicates) and oversteer (where the vehicle is turning more than the steering wheel position indicates). The illustration at right shows how selective braking at a particular wheel can create a compensating yaw moment to help restore the vehicle's actual path to the path indicated by the steering wheel position.

Q. Will a tire change affect StabiliTrak?

A. Use of tires other than original equipment may affect StabiliTrak performance. StabiliTrak is designed to make the best use of available traction. The performance characteristics of the original equipment tires are part of the overall system effectiveness. When you replace tires check the recommendations in your Owners Manual. On GM vehicles, the original equipment tires have a "TPC" (Tire Performance Criteria) code on the sidewall. Replacing the tires with the same "TPC" code will help assure proper StabiliTrak performance.

UPDATES FOR 2012



NEW FEATURES

- (L20) Engine 4.8L V8 SFI FlexFuel standard with 1LS model
- (L96) Engine 6.0L V8 SFI FlexFuel optional with 1LS model

2 | EXPRESS TRANSPORT VAN – 1LS AND 2LS

Note: This vehicle is NOT designed nor intended for use IN HIGH SPEED EMERGENCY VEHICLE OPERATIONS

MODEL AVAILABILITY

CG33406-1LS	Rear-wheel drive
CG33706-2LS (DIESEL)	Rear-wheel drive

STANDARD EQUIPMENT SUMMARY

WARRANTY	3 years / 36,000 mile bumper-to-bumper (whichever comes first, see dealer for details) 5 years / 100,000 mile limited powertrain (whichever comes first, see dealer for details)
----------	---

INTERIOR FEATURES

AIR CONDITIONING	Single-zone, manual	RESTRAINT SYSTEM	Seat belts, driver and front passenger with pretensioners, dual stage driver and passenger frontal air bags ¹ , passenger sensing system and frontal air bag ¹ ON/OFF indicator, rollover sensor, and dual head curtain air bags ¹ for front and rear seat outboard occupants
CUP HOLDERS	Three on engine console cover	SEATS, FRONT	Vinyl high-back buckets, adjustable and reclining
DEFOGGERS	Front and side windows	SEATS, REAR	Vinyl trimmed rear bench seats and split 4 passenger last seat
DOMELAMPS	Three dome lamps, with defeat switch and door-activated switches	SEATING	12 passenger seating
DRIVER INFORMATION CENTER	See order guide	SPEEDOMETER/CLUSTER	Analog with speedometer, odometer with trip odometer, fuel level, volt meter, engine temperature and oil pressure
FLOOR COVERING	Full-length Black rubberized-vinyl	STEERING COLUMN	Tilt
MIRROR	Inside rearview manual day/night	THEFT DETERRENT	Vehicle theft PASS-Key® III
POWER OUTLETS	Two auxiliary on engine console with cover 12-volt		
RADIO	AM/FM stereo, seek-and-scan, digital clock and 2 front door speakers		

EXTERIOR FEATURES

BUMPER, FRONT	Painted, Black	GRILLE	Black composite
BUMPER, REAR	Painted, Black with step pad	HEADLAMPS	Single rectangular halogen
DOORS	Swing-out side, 60/40 split on passenger side only	LAMPS	Daytime running
GLASS	Solar-Ray, deep tinted; enhanced technology rear most side glass (All windows except light-tinted on windshield and driver and front passenger side glass, enhanced-technology, rear most side windows. 3-layer special glass is designed to help reduce the risk of ejection during a crash, swing-out rear cargo door windows, swing-out side door windows)	LICENSE PLATE KIT	Front
		MIRRORS	Outside, rearview, manual, foldaway, Black
		TIRE PRESSURE MONITOR	CHECK TIRE PRESSURE (no spare tire sensor)
		WINDSHIELD WIPERS	Intermittent wet-arm with pulse washers

CHASSIS FEATURES

ALTERNATOR	105-amp with out rear A/C, 145-amp with rear A/C, 145-amp standard on 2LS model	STEERING	Power
BATTERY	600 cca with run-down protection and retained accessory power on 1LS model. Dual heavy-duty 770 cca standard on 2LS model	SUSPENSION, FRONT	Independent with coil spring and stabilizer bar
BRAKES	4-wheel disc, with 4-wheel anti-lock	SUSPENSION, REAR	Hypoid drive axle with multi-leaf springs
ENGINE	Vortec 4.8L V8, SFI FlexFuel ² on 1LS model. 6.6L V8 turbo diesel on 2LS model	TIRES	LT245/75R16E all-season, blackwall with full-size spare located under rear underbody
EXHAUST	Aluminized stainless-steel muffler and tailpipe	TIRE PRESSURE MONITOR	CHECK TIRE PRESSURE will show on driver message center
FUEL TANK CAPACITY	31 gallon (117.3 liters)	TRANSMISSION	6-speed automatic, heavy-duty, electronically controlled with overdrive and tow/haul mode and internal transmission oil cooler
MONITOR	Oil life	WHEELS	16" x 6.5" steel includes Gray center cap and steel spare
OIL COOLER	External transmission		
STABILITRAK	Vehicle stability control		

1. Head curtain side air bags are designed to help reduce the risk of head and neck injuries to front and rear seat occupants on the near side of certain side-impact collisions. Always use safety belts and the correct child restraints for your child's age and size, even in vehicles equipped with air bags. Children are safer when properly secured in a rear seat. See your vehicle Owner's Manual and child safety seat instructions for more information.

2. E85 is 85% ethanol and 15% gasoline. To see if there is an E85 station near you, go to www.gmaltfuel.com/e85-station-locator.

POWERTRAIN

ENGINE					TRANSMISSION		AXLE	
MODEL	CODE	TYPE	DISPLACEMENT LITERS/CU. IN.	FUEL SYSTEM	STANDARD	TYPE	OPTION CODE	RATIO
1LS Standard	L20 Vortec	V8	4.8L/293	SFI FlexFuel ²	Automatic MXO	Automatic HD 6-speed	GU6	3.42
1LS Optional	L96 Vortec	V8	6.0L/366	SFI FlexFuel ²	Automatic MXO	Automatic HD 6-speed	GU6	3.42
2LS Standard	LGH Duramax	V8	6.6L/403	Turbo diesel	Automatic MXO	Automatic HD 6-speed	GHO	3.54

Note: Emission type must be ordered

FE9 - Federal YF5 - California NG1 - Northeast States

SEATS AND INTERIOR TRIM

	SEAT OPTIONS	EBONY	COLOR
STANDARD Front: Vinyl trimmed high-back buckets, inboard armrests and reclining Rear: Vinyl trimmed bench seat and split four passenger last seat	AR7	93W	Medium Pewter
OPTIONAL Front: Bucket with custom cloth trim, head restraints and inboard armrest Rear: Bench seats with custom cloth (head restraints not available on rear bench seats)	AS5	93G	Medium Pewter

Note: Vinyl trim only available in Medium Dark Pewter

EMISSIONS - MUST BE SPECIFIED

FE9	FEDERAL EMISSIONS. Use for ordering vehicles that will be registered in all states except California, Connecticut, Maine, Maryland, Massachusetts, New Jersey, New Mexico, New York, Oregon, Pennsylvania, Rhode Island, Vermont and Washington State
YF5	CALIFORNIA EMISSIONS. Use for ordering vehicles that will be registered in California.
NE1	CT/ME/MD/MA/NJ/NM/NY/OR/PA/RI/VT/WA EMISSIONS. Use for ordering vehicles that will be registered in Connecticut, Maine, Maryland, Massachusetts, New Jersey, New Mexico, New York, Oregon, Pennsylvania, Rhode Island, Vermont or Washington State
NB8	Required when option code FE9 "FEDERAL EMISSIONS" is ordered for delivery to a dealer located in California, Connecticut, Massachusetts, Maryland, New Jersey, New Mexico, New York, Oregon, Pennsylvania, Rhode Island and Washington State for a purchaser who will be registering the vehicle outside California, Connecticut, Maine, Maryland, Massachusetts, New Jersey, New Mexico, New York, Oregon, Pennsylvania, Rhode Island, Vermont and Washington State.
NC7	Required when option code YF5 "CALIFORNIA EMISSIONS" or option code NE1 "CT/ME/MD/MA/NJ/NM/NY/OR/PA/RI/VT/WA EMISSIONS" is ordered for delivery to a dealer located in any state except California, Connecticut, Maine, Maryland, Massachusetts, New Jersey, New Mexico, New York, Oregon, Pennsylvania, Rhode Island, Vermont and Washington for a purchaser who will be registering the vehicle in one of these states or sold as permitted below under "EPA Policy on the Sale of California Emission Vehicles"
NB9	Required when option code YF5 is ordered for delivery to a dealer located in Connecticut, Maine, Maryland, Massachusetts, New Jersey, New Mexico, New York, Oregon, Pennsylvania, Rhode Island, Vermont and Washington. Required when option code NE1 is ordered for delivery to a dealer located in California.
Requirements for Diesel Engines in Vehicles Over 14,000 lbs GVWR: Different requirements apply to vehicles weighing over 14,000 lbs GVWR that are equipped with diesel engines. These requirements impact the Chevrolet Express and GMC Savana Vans weighing over 14,000 lbs GVWR that are equipped with the 6.6-liter Duramax diesel engine (LMM). For these vehicles, a different set of states has adopted California emission requirements, specifically, California, Connecticut, Delaware, Georgia, Maine, New Jersey, North Carolina and Pennsylvania. And GM has established a different set of emission options for use by dealers as follows.	
CEJ	FEDERAL EMISSIONS. Use for ordering vehicles that will be registered in all states except California, Connecticut, Delaware, Georgia, Maine, New Jersey, North Carolina and Pennsylvania.
YF5	CALIFORNIA EMISSIONS. Use for ordering vehicles that will be registered in California. Note: No 14,200 lb product offering available except for models with option packages ANC, B3D, YF1, or YF2
CEI	CT/DE/GA/ME/NJ/NC/PA EMISSIONS. Use for ordering vehicles that will be registered in Connecticut, Delaware, Georgia, Maine, New Jersey, North Carolina and Pennsylvania. Note: No 14,200 lb product offering available except for models with option packages ANC, B3D, YF1, or YF2.
GM has also established a different set of emission overrides as follows.	
CEK	Required when option code CEJ "FEDERAL EMISSIONS" is ordered by a dealer located in California, Connecticut, Delaware, Georgia, New Jersey, North Carolina and Pennsylvania for a purchaser who will be registering the vehicle outside California, Connecticut, Delaware, Georgia, Maine, New Jersey, North Carolina and Pennsylvania. Do not use for vehicles that will be registered in California, Connecticut, Delaware, Georgia, Maine, New Jersey, North Carolina or Pennsylvania.
CEM	Required when option code YF5 "CALIFORNIA EMISSIONS" or option code CEI "CT/DE/GA/ME/NJ/NC/PA EMISSIONS" is ordered by a dealer located in any state except California, Connecticut, Delaware, Georgia, New Jersey, North Carolina and Pennsylvania.

2. E85 is 85% ethanol and 15% gasoline. To see if there is an E85 station near you, go to www.gmaltfuel.com/e85-station-locator.

4 | EXPRESS TRANSPORT VAN 1LS AND 2LS OPTIONS

AVAILABLE OPTIONS

C69	AIR CONDITIONING, REAR - Requires TR9 auxiliary lamps, includes C36 rear heater, U80 digital compass and KG3 145-amp alternator.
KG3	ALTERNATOR, 145 AMPS - Included with C69 rear air conditioning.
US8	AUDIO SYSTEM - AM/FM stereo with CD/MP3 player, seek-and-scan, digital clock, auto-tone control, Radio Data System (RDS), two front door speakers and two rear door speakers and two in the sound bar, requires ZQ2 Convenience Package.
U1C	AUDIO SYSTEM - AM/FM stereo with CD player, seek-and-scan, digital clock, theftlock, random select and 2 front door speakers, not available with NP5 leather wrapped steering wheel.
USR	AUDIO SYSTEM FEATURE - USB port, included and only available with US8 AM/FM stereo with MP3 compatible CD player
UA1	BATTERY - Heavy-duty 770 cca, maintenance-free with rundown
UPF	BLUETOOTH FOR PHONE ¹⁰ - Personal cell phone connectivity to vehicle audio system, requires UE1 OnStar [®] , US8 AM/FM stereo with MP3 compatible CD player, U2K XM Radio ⁹ , NP5 leather-wrapped steering wheel, W1Y steering wheel controls, ZQ3 Convenience Package. Not available with UE0 OnStar delete
V37	BUMPERS - Front and rear chrome with step pad (included with ZR7 Chrome Appearance Package)
ZR7	CHROME APPEARANCE PACKAGE - Includes V37 front and rear chrome bumpers with step-pad and V22 chrome grille with dual composite halogen headlamps
V10	COLD CLIMATE PACKAGE - Includes engine block heater (includes K08 if ordered with 6.6L turbo diesel)
U80	COMPASS - 8-point digital located in the Driver Information Center, included and only available with C69 rear air conditioning.
BA3	CONSOLE - Deluxe with swing-out storage bin
ZQ2	CONVENIENCE PACKAGE - Power windows and door locks, includes AU3 power door locks and A31 power windows. Included with PDN Power and Light Package.
ZQ3	CONVENIENCE PACKAGE - Tilt-wheel and cruise control
K34	CRUISE CONTROL - Included and only available with ZQ3 Convenience Package, tilt-wheel and cruise control.
C49	DEFOGGERS - Rear window, requires tinted glass
YA2	DOOR - Sliding passenger, side (requires C69 rear air conditioning)
AU3	DOOR LOCKS - Power with lock-out protection (included with ZQ2 Convenience Package)
K05	ENGINE BLOCK HEATER - Included and only available with V10 Cold Climate Package which requires L96 Vortec 6.0L V8 SFI FlexFuel ² engine
B30	FLOOR COVERING - Full-floor color-keyed carpeting with front and rear rubberized-vinyl floor mats
V22	GRILLE - Chrome with dual composite halogen headlamps (included and only available with ZR7 Chrome Appearance Package)
K08	HEAT GENERATOR - Auxiliary-fuel-operated supplemental heat source to cooling system to improve heat out put (included with V10 and LGH Duramax 6.6L turbo diesel)
C36	HEATER, REAR AUXILIARY - Included with C69 rear air conditioning.
UF3	HIGH IDLE SWITCH - Requires *G33*06, L96 Vortec 6.0L V8 SFI engine and ZQ3 Convenience Package.
TR9	LAMPS - Lamps, auxiliary with reading and underhood lamps, requires C69 rear air conditioning. Includes DH6 driver and front passenger visor vanity mirrors
DE5	MIRRORS - Outside, left hand and right hand, remote control electric, manual foldaway with defog feature (requires ZQ2)
DE7	MIRRORS - Outside heated power-adjustable, Black, manual-folding with integrated turn signal indicators, requires ZQ2 Convenience Package.
PDN	POWER PACKAGE - Includes ZQ2 Convenience Package and DE5 outside heated, power-adjustable, Black mirrors (upgradeable to DE7 outside heated, power-adjustable, Black mirrors with turn signal indicators).
ATG	REMOTE KEYLESS ENTRY - Includes 2 transmitters and remote panic button
BTV	REMOTE VEHICLE STARTER SYSTEM - Includes remote keyless entry, 2 transmitters (requires ATG)
ZP3	SEATS - 15-passenger seating (2/3/3/3/4 seating configuration)
AS5	SEATS - Front bucket with custom cloth trim, head restraints and inboard armrests, requires (**G) interior trim. When ordering a seating arrangement that includes rear seats, includes rear bench seats with custom cloth trim. Head restraints are not available on rear bench seats
DT4	SMOKER'S PACKAGE - Includes ash tray and lighter
Z82	TRAILERING SPECIAL EQUIPMENT - Heavy-duty, included platform trailer hitch and 7-wire harness
DH6	VISORS - Driver and front passenger, padded with cloth trim and dual vanity mirrors, illuminated on passenger-side, included and only available with TR9 auxiliary lamps
40P	WHEEL FINISH, PAINTED WHITE - White-painted wheels in lieu of standard Gray-painted wheels
P03	WHEEL TRIM - Chrome center cap, upgradeable to P46 4 - 17" x 7.5" (43.2 cm x 19.1 cm) aluminum
A31	WINDOWS - Power included and only available with ZQ2 Convenience Package









2. E85 is 85% ethanol and 15% gasoline. To see if there is an E85 station near you, go to www.gmaltfuel.com/e85-station-locator.

8. Visit OnStar.com for coverage map, system limitations and details.











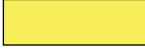

9. XM Radio requires a subscription, sold separately by XM after the trial period. Not available in Canada, Alaska or Hawaii. For more information, visit gm.xmradio.com.

10. Go to gm.com/bluetooth to find out which Bluetooth phones are compatible with the vehicle.

AVAILABLE EXTERIOR COLORS

								
*Sheer Silver Metallic	*Sandstone Metallic	*Graystone Metallic	*Dark Blue Metallic	**Black	*Dark Green Metallic	Summit White	**Victory Red	**Wheatland Yellow (NEW)
Note: * Additional Charge		** Not available with B46 rear body-colored halo trim			Actual colors may vary			

SEO PAINT AVAILABLE

WA#	COLOR DESCRIPTION		CODE
215D	Yellow		
259L	Yellow		
451N	Blue		
478G	Yellow		
519F	Galaxy Silver Metallic		
529F	Bronzemist		
811K	Berry Red		
5456	Yellow		
7927	Green		
7941	Green		
8867	Silver Metallic		
9015	Woodland Green		9V5
9403	Doeskin Tan		9V9
9414	Yellow		
9417	Tangier Orange		9W4

Actual Color May Vary

Note: - All normally body-colored non-sheet metal parts, will be Flat Black
 - SEO paint orders that contain less than five vehicles will be delayed until five unit minimum is received for batch production

6 | EXPRESS TRANSPORT VAN 1LS AND 2LS – SPECIFICATIONS

GENERAL

Model	CG33406
Model	CG33706
Drive	Rear-wheel

	CG33406 1LS/2LS Regular Wheelbase	CG33706 1LS/2LS Extended Wheelbase
--	--	---

EXTERIOR (in./mm)

Wheelbase	135.0/3429	155.0/3937
Overall length	224.1/5692	244.1/6200
Body width	79.2/2012	79.2/2012
Overall height	81.5/2070	82.8/2103
Front bumper to axle	39.7/1008	39.7/1008
Opening height, side door	47.9/1217	47.9/1217
Opening height, rear door	49.4/1255	49.4/1255
Opening width, sliding side door	44.1/1120	44.1/1120
Opening width, rear door, at beltline	57.0/1448	57.0/1448
Step up height, front door	19.4/493	19.3/490
Step up height, side door	19.8/503	19.8/503
Ground clearance, front	8.2/208	8.1/206
Ground clearance, rear	7.1/180	7.7/196

INTERIOR (in./mm)

Head room, 1st row	39.8/1011	39.8/1011
Head room, 2nd row	38.4/975	38.4/975
Head room, 3rd row	38.5/978	37.6/955
Head room, 4th row	37.6/955	37.6/955
Head room, 5th row	–	38.1/968
Shoulder room, 1st row	68.8/1748	68.8/1748
Shoulder room, 2nd row	68.6/1742	68.9/1750
Shoulder room, 3rd row	65.8/1671	65.8/1671
Shoulder room, 4th row	69.1/1755	69.1/1755
Shoulder room, 5th row	–	62.9/1598
Hip room, 1st row	65.5/1663	65.5/1664
Hip room, 2nd row	65.6/1666	65.6/1666
Hip room, 3rd row	63.3/1608	63.3/1608
Hip room, 4th row	65.7/1669	65.7/1669
Hip room, 5th row	–	62.9/1597
Leg room, 1st row	41.3/1049	41.3/1049
Leg room, 2nd row	36.3/922	36.3/922
Leg room, 3rd row	36.6/930	36.6/930
Leg room, 4th row	36.6/930	36.6/930
Leg room, 5th row	–	34.1/866
Ground to top of rear load floor	27.8/706	30.1/765
Load floor length, to front seat, at floor	126.2/3205	146.0/3708
Load floor length, to engine cover, at floor	153.6/3901	173.6/4409
Inside width, between wheelhousing	50.4/1280	50.4/1280
Cargo area height	51.8/1316	51.8/1316

Published dimensions indicated are without optional equipment or accessories. Additional accessories or equipment order at customer's request can result in a minor change in these dimensions.

CAPACITY

Curb weight, lbs. ³ (kg)	6087/2761	6406/2906
Cargo volume, regular, with seats, cu. ft. ³ (liters)	92.1/2608.3	127.2/3602.3
Cargo volume, regular, with seats removed, cu. ft. ³ (liters)	216.2/6122.8	252.8/7159.3
Payload ⁶ , lbs. (kg)	3461/1570	3142/1425
Gross Vehicle Weight Rating ⁵ (GVWR), lbs. (kg)	9600/4354	9600/4354
Front Gross Axle Weight Rating (FGAWR), lbs. (kg)	4600/2087	4600/2087
Rear Gross Axle Weight Rating (RGAWR), lbs. (kg)	6084/2760	6084/2760
Seating capacity (front/2nd/3rd/4th)	2/3/3/3	2/3/3/3/4

3. Cargo and load capacity limited by weight and distribution.

5. Gross Vehicle Weight Rating (GVWR). When properly equipped, includes vehicle, passengers, cargo and equipment.

6. Maximum payload capacity includes weight of driver, passengers, optional equipment and cargo.

ENGINE	1LS STD	1LS OPT	2LS STD
Type	V8	V8	V8
Displacement: liters/cu. in.	4.8/293	6.0/366	6.6/403
Horsepower/rpm	280@5200	323 @ 4600	260 @ 3100
Torque lb.-ft./rpm	295@4600	373 @ 4400	525 @ 1600
Fuel system	SFI	SFI	Turbo Diesel
Compression ratio	–	9.6:1	–
Exhaust	Single	Single	Single
Minimum recommended fuel octane	87	87	–
Fuel tank capacity (gallons/liters)	31/117.3	31/117.3	31/117.3

TRANSMISSION

Automatic heavy-duty	6-speed	6-speed	6-speed
----------------------	---------	---------	---------

AXLE

Ratio	3.42	3.42	3.54
-------	------	------	------

BATTERY

Type	Maintenance free	Maintenance free	Maintenance free
BCI group size	78	78	78
Volts	12	12	12
Amp hour rating	69	69	63
Cold cranking amps @ 0°F (-18°C)	600	600	Dual 770*
Reserve capacity @ 80°F (27°C)	115	115	115

***Standard on 2LS with 6.6L Turbo Diesel**

BRAKES

ABS hydra-boost	Disc/Disc	Disc/Disc	Disc/Disc
Front size	12.8 x 1.50	12.8 x 1.50	12.8 x 1.50
Rear size	13.0 x 1.14	13.0 x 1.14	13.0 x 1.14

TIRES

Type	All-season	All-season	All-season
Size	LT245/75R16	LT245/75R16	LT245/75R16

WHEELS

Type	Steel	Steel	Steel
Size	16" x 6.5"	16" x 6.5"	16" x 6.5"

CHASSIS

Frame	Full length boxed frame	Full length boxed frame	Full length boxed frame
Front suspension	Independent with coil spring and stabilizer bar	Independent with coil spring and stabilizer bar	Independent with coil spring and stabilizer bar
Rear suspension	Hypoid driver axle w/multi-leaf springs	Hypoid driver axle w/multi-leaf springs	Hypoid driver axle w/multi-leaf springs
Steering type	Speed sensitive (EVO), variable ratio, integral power	Speed sensitive (EVO), variable ratio, integral power	Speed sensitive (EVO), variable ratio, integral power
Steering ratio (center/stop)	17.2:1	17.2:1	17.2:1

ALTERNATOR

Type	Standard with rear AC	TBD	TBD	AD244
Amps	*105	*105	*105	145
Amps @ idle	TBD	TBD	TBD	59

***Without Rear air conditioning. 145 AMP required with rear air conditioning**

Can specialty vehicle equipment (e.g. radar devices, video cameras, computers, meters, radio trees, shotguns, etc.) still be mounted in cars with passenger side air bags?

Yes, but care must be taken to mount the equipment outside of the deployment zone. Air bags inflate with great force and will interact with any object in the deployment zone. Therefore, to reduce the risk of injury to vehicle occupants, GM recommends that the air deployment zone be kept free of any equipment. If a piece of equipment were to become dislodged it could strike an occupant in the vehicle and result in injury. The likelihood of an object becoming dislodged is influenced by many factors, including the proximity of the object to the inflatable restraint, the size and shape of the object, and the means by which the object is secured to the vehicle. In addition to these factors, the trajectory and velocity of a dislodged object can be influenced by the type and severity of vehicle crash.

Objects that are in the deployment zone, but do not become dislodged by an inflating air bag can still affect the performance of the air bag. For example, such objects could tear the fabric or affect the shape of the air bag, thus reducing the ability of the bag to provide restraint.

Is it possible to shield equipment that is installed in the passenger side frontal air bag deployment zone in a manner that will allow full and safe air bag deployment?

Due to the complexity of influencing variables, GM is unable to evaluate the potential for shielding expected equipment configurations in all accident scenarios in order to assure that the air bag performance would be unaffected. While shielding may protect certain equipment from being damaged or dislodged, it may also negatively affect the inflation characteristics of the air bag. The air bag's shape, inflation angle, fold pattern, and inflation rate and pressure are developed to maximize the protection capability of the inflatable restraint system. Therefore, GM cannot recommend the placement of any equipment in the deployment zone, even if it is shielded to protect it from damage.

Front air bag systems and instrument panel mounted equipment.

Passenger air bags in GM vehicles deploy in different ways depending upon the type of vehicle and the particular instrument panel design.

In some vehicles, the passenger air bag deploys through a discrete door located on the top surface of the instrument panel (top-mount air bag systems). In other vehicles, such as the Chevrolet Tahoe, the passenger air bag deploys through a discrete door mounted on the vertical rearward surface of the instrument panel, above the glove box door (mid-mount air bag system). With these types of top-mount and mid-mount passenger air bag systems, the top pad of the instrument panel remains in place during deployment.

Some GM passenger air bag systems, like the system in the Chevrolet Impala, deploy from beneath the instrument panel top pad. These are considered 3/4-mount air bag systems with a "deployable top pad." The entire instrument panel top pad is the "deployment door" from under which the inflating air bag emerges. When an air bag deployment is commanded, the forces from the inflating passenger air bag push up on the instrument panel top pad, releasing special fasteners across the rearward edge of the top pad. This allows the top pad to rotate upward so that the passenger air bag may emerge. The top pad rotates upward to open widest at the right hand side, and is usually forced upward into contact with the windshield on the right hand side of the vehicle during a deployment.

Head curtain side air bags are designed to help reduce the risk of head and neck injuries to front and rear seat occupants on the near side of certain side-impact collisions. Always use safety belts and the correct child restraints for your child's age and size, even in vehicles equipped with air bags. Children are safer when properly secured in a rear seat. See your vehicle Owner's Manual and child safety seat instructions for more information.

Instrument panel top mounted special equipment, such as a radar antenna and control unit or video camera must be positioned to the left of the vehicle center line. This equipment must be mounted as low as possible and securely fastened to the top pad to avoid being dislodged in the event of a crash and possible air bag deployment. In the process of securely fastening special equipment to the top, DO NOT fasten down the top pad itself to any other vehicle component such as the cluster trim plate. As described above, the top pad rotates upward during a deployment. In order to enable the proper deployment of the passenger air bag, specialty equipment installation MUST NOT PREVENT the top pad from rotating upward during deployment. Location and attachment of special equipment should minimize added resistance or interference to upward rotation of the top pad during deployment.

Optional side air bags for crashes to the vehicle sides.

The air bag system in your police vehicle may include optional side air bags for front and rear occupants. Most front-to-rear side air bags are designed to deploy downward from the interior roof sides to the bottom of the door windows.

Can Specialty Vehicle Security Barriers be mounted within the side air bag deployment zones?

No. The side air bags inflate extremely fast because of the nature of side crashes to the vehicle. Mounting a security barrier behind the front seats with the ends placed within the side air bag deployment zones will result in unintended interaction between the barrier and the inflating side air bags. To reduce the risk of injury to the vehicle occupants, GM recommends that the side air bag zones be kept free of any customer installed equipment.

Customer furnished equipment installed to the vehicle roof.

Your police vehicle is designed with an interior roof cover system which includes internal components for the interior lamps and wiring. The roof system may also include optional side air bag components. Inflation devices may be mounted on the vehicle roof side behind the rear doors as well as air bag tethers retained to the windshield pillars. Care must be taken to avoid damage to these components or interference with their operation when installing roof mounted equipment such as emergency lamps and communication antennas.

Recommended GM service procedures must be followed to remove and re-install the instrument panel top pad to ensure that the top pad will release properly in the event of a passenger air bag deployment.

On the right half of the top pad closest to the passenger air bag module, GM recommends that no equipment be mounted. When mounting equipment on the driver side of the top pad, GM recommends that the total mass of the top pad mounted special equipment not exceed 8 pounds (3.6 kilograms), since the top pad tends to rotate about the left end.

Fasteners used to secure special equipment to the instrument panel top pad, the windshield glass, or to the windshield upper frame (header), should be selected to ensure that these devices will remain attached during a vehicle crash and possible air bag deployment.

Can the installation of push bumpers on the front end of the vehicle affect the deployment of the air bag?

General Motors is not aware of adverse effects during crash events from the many push bumpers that have been installed on GM police vehicles. Because there are many styles of push bumpers available with varying crash characteristics, installation of push bumpers may or may not affect deployment timing of the air bags. Push bumpers should be mounted to avoid modifying the vehicle structure and interfering with the front air bag sensors mounted on the upper radiator support cross member.

Two front impact sensors are installed in General Motors vehicles. Do not relocate or disconnect the front sensors. The location and orientation of the front sensors are critical for correct operation of the air bag system. Avoid mounting components on or near the sensors. Push bumper styles with vertical pushing members that are in fore-aft alignment with the front air bag sensors are not recommended.

How long will the air bag remain inflated?

It takes approximately 1/20th of a second to fully inflate the frontal air bags. This is faster than the blink of an eye. The air bags begin to deflate immediately, helping to stop the occupants more gradually.

Can the air bag system be re-used?

No. The air bags are designed to inflate only once. After inflation some new parts will be required. These will include the air bag module and possibly other parts. (A competent service technician with access to the vehicle's service manual and the required tools should replace the required components after a deployment crash.)

I've heard that the dusts that are released into the passenger compartment from the air bag are harmful. Is this true?

For most people, the only effect the dusts will produce is some irritation of the throat and eyes, and that is only if the occupant remains in the vehicle for many minutes after the air bag deployment with no ventilation and windows closed. However, some people with asthma may develop an asthmatic attack from inhaling the dusts. If this happens, they should first treat themselves the same way their doctor has advised them to treat any other asthma attack, and then immediately seek medical treatment.

When should an air bag inflate?

The driver's and right-front passenger's frontal air bags are designed to inflate in moderate to severe frontal or near-frontal crashes. But they are designed to inflate only if the impact speed is above the system's designed "threshold level."

In addition, if your vehicle has "dual stage" frontal air bags, these air bags tailor the amount of restraint according to crash severity. For moderate frontal impacts, the air bags inflate at a level less than full deployment. For more severe frontal impacts, "dual stage" frontal air bags deploy at full levels.

If the front of your vehicle goes straight into a wall that doesn't move or deform, the threshold level of the reduced deployment is about 12 to 16 mph (19 to 15 km/h), and the threshold level for a full deployment is about 18 to 24 mph (29 to 28.5 km/h). The threshold level can vary, however, with specific vehicle design, so that it can be somewhat above or below this range.

If your vehicle strikes something that will move or deform such as a parked car, the threshold level will be higher. The driver's and right-front passenger's frontal air bags are not designed to inflate in rollover, side impacts, or rear impacts, because inflation would not help the occupant.

Seat mounted side impact air bags are designed to inflate in moderate to severe side crashes. The side impact air bags will inflate if the crash severity is above the designed "threshold level." The threshold level can vary with specific vehicles design. The side impact air bags are not designed to inflate on frontal or near-frontal impacts or rear impacts, because inflation would not help the occupant.

Roof rail mounted head-curtain air bags are designed to inflate in moderate to severe side crashes. In addition, certain vehicles have head-curtain air bags which are also designed to inflate in situations where an impending rollover condition is identified by the vehicle's rollover sensing system and/or frontal or near-frontal impacts if the crash severity is above the designed "threshold level".

Safety belt pretensioners at the driver and front passenger seat positions are designed to deploy in frontal, near-frontal, side, and rear crashes that exceed the "threshold level" of crash severity to help reduce slack in the safety belt. Safety belt pretensioners will also deploy in impending rollover situations.

I've heard that a deployed air bag produces what appears to be smoke. Is the air bag hot?

After the bag has deployed in a crash, the air bag itself will not be hot to touch. Some components within the air bag module will be hot for a short time. A small amount of smoke coming from a deployed air bag module is normal and should not be cause for concern.

Also, when the nitrogen gas is vented out of the air bag, small particles from inside the bag are also vented into passenger compartment. These airborne particles look like smoke and some particles are deposited as residue on and around the air bag.

If my vehicle has air bags, why should I have to wear my safety belt?

Air bags are in many vehicles today and will be in most of them in the future. But they are supplemental systems only; so they work with safety belts - not instead of them. Every air bag system ever offered for sale has required the use of safety belts. Even if you're in a vehicle that has air bags, you still have to buckle up to get the most protection. That's true not only in frontal collisions but especially in side and other collisions.

OVERHEAD VIEW

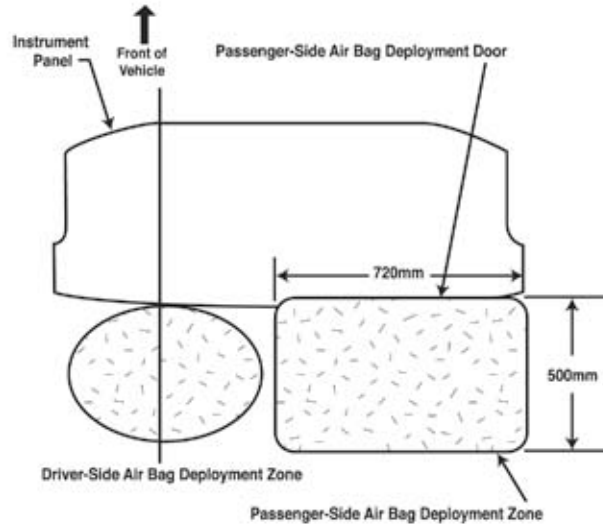

REAR VIEW

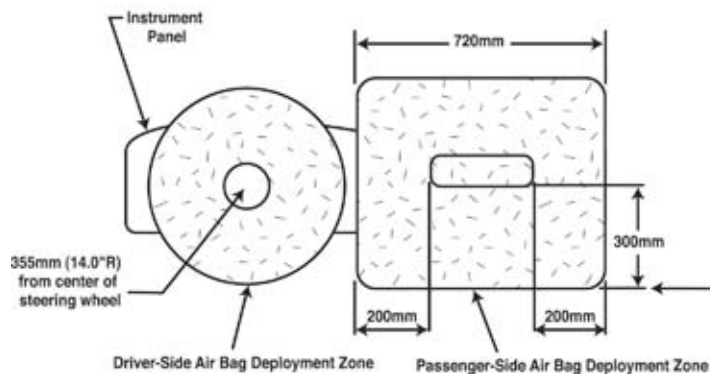

RIGHT SIDE VIEW

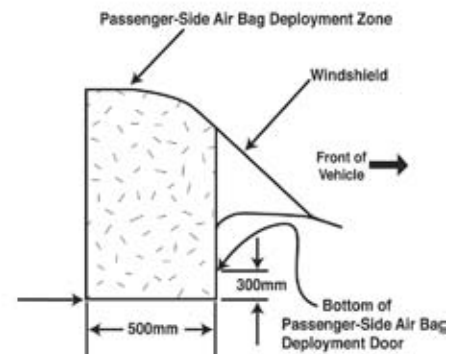

Head curtain side air bags are designed to help reduce the risk of head and neck injuries to front and rear seat occupants on the near side of certain side-impact collisions. Always use safety belts and the correct child restraints for your child's age and size, even in vehicles equipped with air bags. Children are safer when properly secured in a rear seat. See your vehicle Owner's Manual and child safety seat instructions for more information.

Note: All dimensions are approximate and subject to change.

10 | AIR BAG DIMENSIONS – EXPRESS TRANSPORT VAN

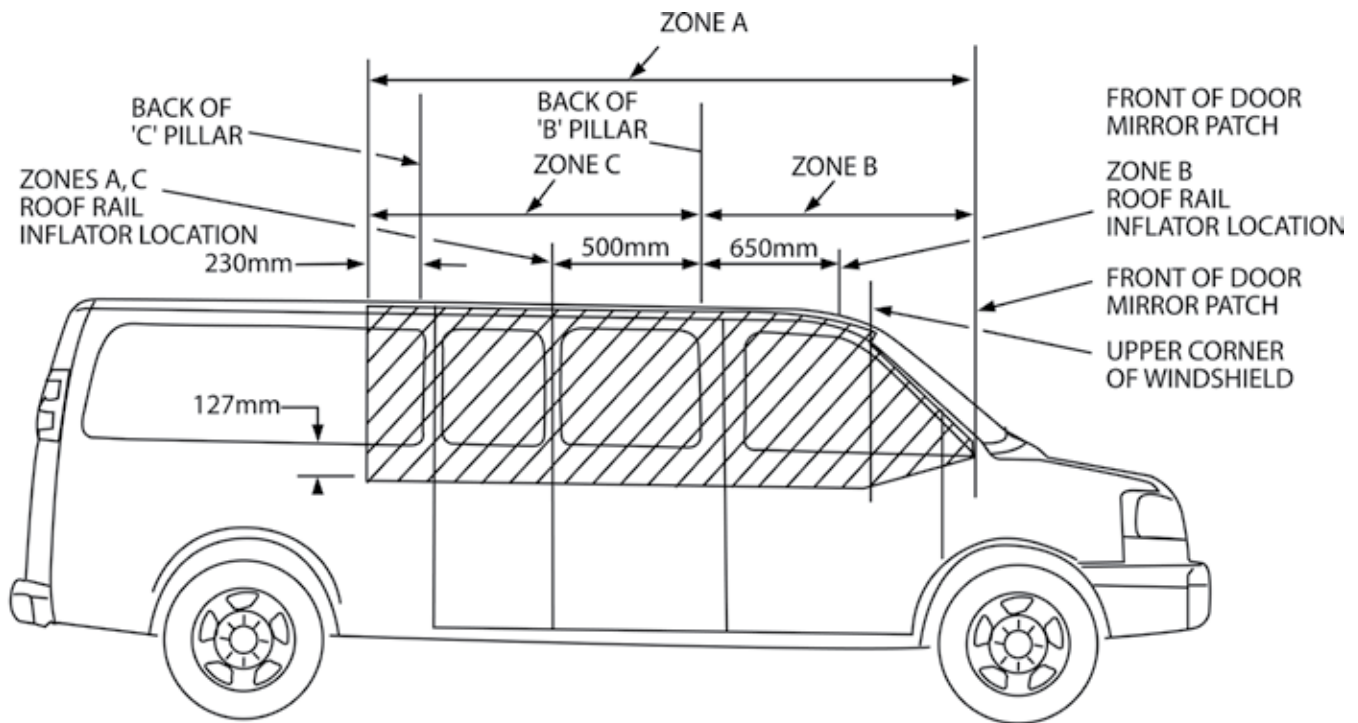

LONG W.B. SHOWN, SHORT W.B. SIMILAR

AIR BAG ZONE	USAGE	VEHICLE DESCRIPTION
A	LH/RH	PASSENGER VAN WITH RH SIDE 60/40 SWING OUT DOOR
A	LH	PASSENGER VAN WITH RH SLIDING DOOR
B & C	RH	
B	LH/RH	CARGO/WORK VAN (DRIVER/FRONT PASSENGER ONLY)

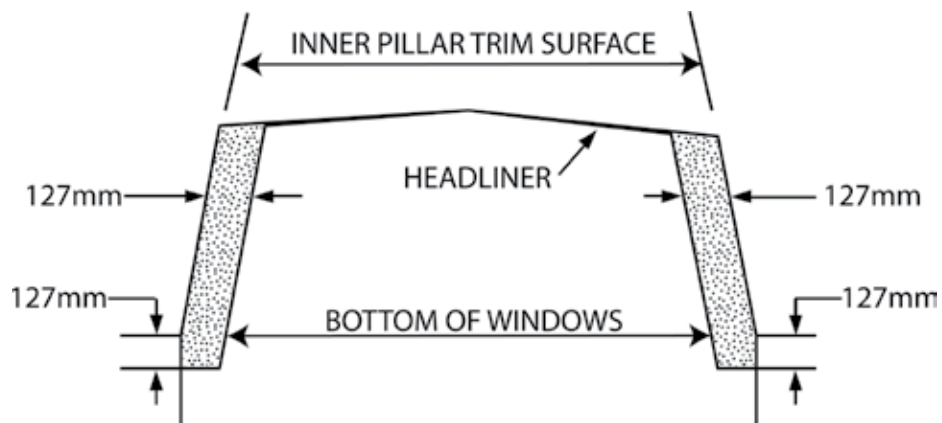

ROOF RAIL AIR BAG DEPLOYMENT ZONES VIEWED FROM REAR

Head curtain side air bags are designed to help reduce the risk of head and neck injuries to front and rear seat occupants on the near side of certain side-impact collisions. Always use safety belts and the correct child restraints for your child's age and size, even in vehicles equipped with air bags. Children are safer when properly secured in a rear seat. See your vehicle Owner's Manual and child safety seat instructions for more information.

Note: All dimensions are approximate and subject to change.

GM offers Anti-Lock Brake Systems as standard or optional on all North American passenger vehicles and light truck lines. The computerized Anti-Lock Braking System (ABS) is designed to keep the vehicle's wheels rotating as the brakes are applied to assist the driver in achieving a controlled stop. Sensors monitor how fast the wheels rotate and feed the data continuously to the ABS computer. The vehicle's brakes slow each wheel as the brake pedal is applied. However, when ABS is activated due to road conditions, the system repeatedly releases and applies pressure to the brakes. The wheels can keep rolling, thus retaining steering ability and enhanced stability while providing a higher braking force on most surfaces than a locked wheel provides.

How exactly does ABS work?

In cars without ABS, hitting the brakes can cause the wheels to lock, leaving you unable to steer the vehicle until you decrease the pressure so the wheels can roll again. With an ABS, as you apply the brakes, the ABS computer monitors the wheel speed sensor information. If the computer senses that a wheel is approaching lock up, it sends a signal to the hydraulic modulator to reduce, then to reapply, brake pressure several times a second for as long as you maintain firm pressure on the brake pedal. The process is much like the threshold braking technique used with conventional brakes. However, ABS does it much faster and more accurately than any driver can, leaving you free to focus on steering away from obstacles.

Does ABS reduce stopping distances?

Yes, in braking situations where the wheels on a non-ABS equipped vehicle would lock up, ABS will generally provide shorter controlled stopping distance. The amount of improvement in stopping distance depends on many factors, including the road surface, severity of braking, initial vehicle speed, etc. On some surfaces, such as gravel roads, braking distances can be longer, but you will still have the control benefits of ABS. The important capability of ABS is control. ABS provides improved vehicle steerability and stability when braking.

What can affect the ABS advantage?

It is important that you follow the maintenance schedule recommended in the owner's manual of the vehicle, tires should be at their proper inflation level, the brake pads should be checked regularly, etc. While driving, you should sit comfortably, so that your hips are back in the seat and your knees are bent, even while braking. Your foot should be positioned so that your heel is on the floor and your toes are secure on the lower half of the pedal. And, though ABS may reduce stopping distance, remember: The faster you go, the longer it takes you to stop. Keeping a safe distance between you and the vehicle in front of you is always necessary, even with ABS.

What happens if ABS becomes inactive?

The ABS electronic control unit has on-board diagnostic capability. If a fault is detected, the vehicle will revert to the base brake system, and the ABS telltale on the dash will be illuminated. Should this happen, the vehicle should be taken to a dealership for repair as soon as possible.

How do I use ABS?

Depress and hold the pedal. DO NOT PUMP THE BRAKES (that prevents the system from working). Just hold the brake pedal down and let the ABS work for you. You may feel the brake pedal vibrate, or you may notice some noise, but this is normal as the system works for you.

Should I drive an ABS equipped vehicle differently than I would drive a vehicle with conventional brakes?

Most of the time, under normal driving circumstances, there is no difference, and you should always drive with the same caution and care. It is important to realize that ABS only makes a difference when it is activated—when you have to brake hard—and that would only be when the computer senses that a wheel is approaching lock up. When ABS activates keep steady pressure on the brake pedal and then let the ABS work for you. Don't pump the brakes or try to find the threshold. Simply hold the brake pedal down and steer if necessary to avoid an obstacle.

Is ABS always active?

ABS is always available, but not always activated. ABS is activated only when the brake pedal is applied and the computer detects an impending wheel lock condition.

Can older cars be retrofitted with ABS?

No! The brake system is one of the most important features on any passenger vehicle. Several products, which tap into the master cylinder and/or brake system performance, are being sold in the aftermarket. Some of these products imply performance similar to new vehicle anti-lock brake systems.

However, contrary to their claims, add-on systems, which deplete fluid from the master cylinder on brake apply may actually increase a vehicle's stopping distance. This may cause the vehicle to fail to comply with Federal brake standards.

Does ABS always activate at the same speed?

No, the system operates when the computer detects wheel lockup, at any speed above 8 mph.

Will ABS wear out a vehicle's brakes sooner?

A properly maintained brake system will be unaffected by ABS operation under typical driving conditions.

Are there different types of ABS?

Yes, there are rear wheel anti-lock systems (RWAL) used on some trucks and four-wheel ABS available on cars and trucks.

Do Federal Safety Standards mandate ABS?

No. Federal standards establish minimum braking performance requirements that all vehicles must meet, but do not specify how they should be met. It should be noted that even a vehicle with failed ABS meets the Federal safety standard for stopping distances.

Will a tire size change affect ABS?

Use of tires other than original equipment may affect ABS performance. Owners should consult and follow the recommendations contained in the vehicle owner's manual regarding replacement tire size. *Note: ABS will work with original equipment spare tire or tire chains. However, performance is reduced.*

Do insurance companies give a discount for ABS?

Yes, many insurance companies give discounts that range from 5% to 10%. In the states of New York and Florida all insurance companies are required to give an ABS discount of 5% on certain coverages such as bodily injury, property damage, collision, and personal injury protection. In other states the discount varies from insurance company to insurance company. When buying auto insurance, always ask your insurance agent if his/her company gives a discount for vehicles equipped with anti-lock brakes.



IMPORTANT DRIVING SAFETY TIPS



- A. Always maintain a safe following distance.** ABS does not allow you to stop on a dime. (Generally a 2-second following distance is considered safe in ideal conditions.) Watch the vehicle in front of you pass a fixed marker (such as a sign). Count seconds—one-thousand-one, one-thousand-two—until your front bumper reaches the marker. If you do not count out two seconds, then you are too close to the vehicle in front of you. Also, if the roads are wet or icy, or visibility is poor, you should increase your following distance.
- B. Always drive carefully—** especially on slippery surfaces. ABS cannot create friction between the tires and the road surface, it can only give the driver the maximum advantage of the existing adhesion. If the vehicle is traveling on a surface with no adhesion, the best ABS in the world cannot provide a shorter stopping distance or good steering.
- C. It is a good idea to practice an ABS activated stop** and get the feel of the brake pedal. However, please make sure it's at a safe time with no obstacles in your path. And you only really need to try it once or twice to know what happens.

ELECTRONIC STABILITY CONTROL SYSTEMS (STABILITRAK)

StabiliTrak systems help drivers maintain control of their vehicles, especially during emergency lane changes or avoidance maneuvers. StabiliTrak uses various sensors, such as steering wheel angle, wheel speed, yaw velocity, etc., to detect any difference between the path requested by the steering wheel position and vehicle's actual path. When appropriate, the system selectively controls brakes, engine power, and even suspension settings to enhance control of the vehicle's direction and help keep it on course. Independent studies conducted by the National Highway Traffic Safety Administration, the Insurance Institute for Highway Safety, and others have found StabiliTrak to be highly effective in reducing vehicle crashes. General Motors offers StabiliTrak systems on many of its passenger car and light truck models. See your owner's manual for additional information about the operation of StabiliTrak.

Q. How do I use StabiliTrak?

A. StabiliTrak operates independently of the driver. You should continue to drive your StabiliTrak equipped vehicle with caution and care. GM's StabiliTrak system, StabiliTrak, is designed to be as seamless as possible in operation, to be part of the overall vehicle response and to make a good vehicle better

Q. How does StabiliTrak work?

A. StabiliTrak has the ability to apply control forces to the vehicle independent of the driver. StabiliTrak uses sensors to continuously compare the path indicated by the steering wheel position to the vehicle's actual path. If a discrepancy is detected, StabiliTrak selectively controls vehicle brakes and engine torque to create a yaw moment that helps restore the vehicle's actual path to the path indicated by the steering wheel position. StabiliTrak has the ability to help correct both understeer (where the vehicle is not turning as much as the steering wheel position indicates) and oversteer (where the vehicle is turning more than the steering wheel position indicates). The illustration at right shows how selective braking at a particular wheel can create a compensating yaw moment to help restore the vehicle's actual path to the path indicated by the steering wheel position.

Q. Will a tire change affect StabiliTrak?

A. Use of tires other than original equipment may affect StabiliTrak performance. StabiliTrak is designed to make the best use of available traction. The performance characteristics of the original equipment tires are part of the overall system effectiveness. When you replace tires check the recommendations in your Owners Manual. On GM vehicles, the original equipment tires have a "TPC" (Tire Performance Criteria) code on the sidewall. Replacing the tires with the same "TPC" code will help assure proper StabiliTrak performance.

UPDATES FOR 2012



NEW FEATURES

- (GAN) Silver Ice Metallic
- (89U) Crystal Red Tintcoat
- Black Granite Metallic
- Electronic trailer sway control and hill start assist

DELETIONS

- (80U) Red Jewel Tintcoat
- (GGZ) Sheer Silver Metallic

2 | SUBURBAN COMMERCIAL FLEET - 1FL

Note: This vehicle is NOT designed nor intended for use IN HIGH SPEED EMERGENCY VEHICLE OPERATIONS

MODEL AVAILABILITY

CC10906	Rear-wheel drive 1/2 ton
CC20906	Rear-wheel drive 3/4 ton
CK10906	4-wheel drive 1/2 ton
CK20906	4-wheel drive 3/4 ton

STANDARD EQUIPMENT SUMMARY

WARRANTY	3 years / 36,000 miles bumper-to-bumper (whichever comes first, see dealer for details) 5 years / 100,000 miles limited powertrain (whichever comes first, see dealer for details)
----------	---

INTERIOR FEATURES

AIR CONDITIONING	Tri-zone manual climate control with individual climate settings for driver and right-front passenger; includes auxiliary rear air conditioning and heat
ASSIST HANDLES	Front passenger and second row outboard; front passenger assist handle is deleted when passenger side spotlamp is ordered
CONSOLE, OVERHEAD	Mini with map lamps
CRUISE CONTROL	Electronic with set and resume speed
DOMELAMPS	Interior dome lamp, driver and passenger side door switch with delayed entry feature, cargo lamps, remote keyless entry activated illuminated entry and map lamps in front and second seat position
FLOOR COVERING	Black rubberized-vinyl (not available with B39 cargo mat)
GLASS	Deep tinted (all windows except light-tinted glass on windshield, driver and front passenger side glass)
MIRROR	Inside rearview auto-dimming
ONSTAR	Delete option available
POWER OUTLETS	12-volt, two located on instrument panel and one in rear cargo area
RADIO	AM/FM stereo with MP3 compatible CD player, seek-and-scan, digital clock, auto-tone control, Radio Data System (RDS), six speakers, speed-compensated volume and theftlock
RESTRAINT SYSTEM	Safety belts, driver and front passenger with pretensioners, dual stage driver and passenger frontal air bags ¹ , passenger sensing system and frontal air bag ¹ ON/OFF indicator, rollover sensor, dual head curtain air bags ¹ for first and second row outboard occupants and front seat back mounted thorax-pelvic air bags ¹ ; includes 3rd row outboard seating position when 3 passenger third row 50/50 split-bench option AS3 is ordered
SEAT, FRONT	Split-bench 40/20/40 with custom cloth 3-passenger, includes 6-way power driver seat adjuster with manual lumbar control, driver and passenger manual reclining, outboard head restraints, center fold-down covered storage in armrest, center lower seat cushion storage and rear storage pockets
SEAT, REAR	Custom cloth 60/40 split folding bench with center armrest
SEAT, THIRD ROW	50/50 split-bench 3-passenger with premium cloth, safety belts, removable seat
SPEEDOMETER/CLUSTER	120 mph analog speedometer, trip odometer, fuel level, volt meter, engine temperature oil pressure and tachometer
STEERING COLUMN/WHEEL	Tilt-wheel, adjustable, with brake/transmission interlock
THEFT DETERRENT	Vehicle theft PASS-Key [®] III+, content theft deterrent is disabled (to enable content theft deterrent option UA6 must be ordered)
VISORS	Padded with cloth trim, extends on rod; driver and front passenger illuminated vanity mirrors
WARNING TONES	Headlamp on, key-in-ignition, driver and right-front passenger safety belt unfasten and turn signal on
WINDOW OPERATION	Power with driver express-down and lockout features

1. Head curtain side air bags are designed to help reduce the risk of head and neck injuries to front and rear seat occupants on the near side of certain side-impact collisions. Always use safety belts and the correct child restraints for your child's age and size, even in vehicles equipped with air bags. Children are safer when properly secured in a rear seat. See your vehicle Owner's Manual and child safety seat instructions for more information.

EXTERIOR FEATURES

ASSIST STEPS	Black, mounted between front and rear wheels
DEFOGGER	Electric, rear window
DOOR HANDLES	Black
DOOR LOCKS	Power programmable with lockout protection, door lock cylinder no longer available on passenger front door and rear liftgate
FASCIA, FRONT	Color – keyed (Black when special paint is ordered)
FASCIA, REAR	Color – keyed (Black when special paint is ordered)
HEADLAMPS	Dual halogen composite with automatic exterior lamp control and flash-to-pass feature
KEYLESS ENTRY	Includes two transmitters
KEYS	Single two-sided, random code, for ignition and drivers door only
LUGGAGE RACK	Roof mounted Black side rails (center rails and luggage rack delete are available)
MIRRORS	Outside heated power-adjustable, manual-folding, Black
REAR LIFTGATE	Liftgate/liftglass, with rear window washer and wiper (power liftgate not available)
RECOVERY HOOKS	Two front, chrome
WINDSHIELD WIPERS	Intermittent wet-arm with flat blade and pulse washers

CHASSIS FEATURES

ALTERNATOR	145-amp on 3/4 ton 160-amp on 1/2 ton models and with VYU Snow Plow Prep Package on 4-wheel drive 3/4 ton models; not available on 2-wheel drive 3/4 ton models
BATTERY	Heavy-duty 730 cca, maintenance-free, rundown protection and retained accessory power
BRAKES	4-wheel antilock, 4-wheel disc, vac power 1/2 ton models only; 4-wheel antilock, 4-wheel disc with hydro boost 3/4 ton models only
ENGINE	See engine, transmission and axle chart on page 4
FRAME	Modular with hydro formed frame rails
FUEL TANK CAPACITY	31 gallon (117.3 liters) on 1/2 ton models and 39 gallon (148 liters) on 3/4 ton models
OIL COOLERS	Auxiliary transmission oil cooler, heavy-duty air-to-oil (requires 3.42 axle ratio on 1/2 ton models) standard with 3/4 ton models
STABILITRAK	Vehicle stability control system with proactive roll avoidance
STEERING	Power, rack and pinion
SUSPENSION, FRONT	Coil-over-shock with stabilizer bar 1/2 ton models only; independent with torsion bar 3/4 ton only
SUSPENSION, REAR	Multi-link with coil springs 1/2 ton model only; multi-stage leaf springs 3/4 ton models only
TIRES	See tire and wheel chart on page 5
TIRE PRESSURE MONITOR	CHECK TIRE PRESSURE will show on Driver Information Center (no sensor in spare tire)
TIRE, SPARE	See tire chart on page 5
TIRE, SPARE CARRIER	Lockable outside, winch-type mounted under frame at rear
TRAILERING EQUIPMENT	Heavy-duty includes trailering hitch platform, 7-wire harness with independent fused trailering circuits mated to a 7-way sealed connector and VR4 2-inch trailering receiver. Electronic trailer sway control and hill start assist
TRANSFER CASE	Active single-speed, electronic autotrac with rotary controls, does not include Neutral (N). Cannot be dinghy towed, requires GU4 3.08 rear axle. Not available on 2WD models, 3/4 ton models or with K5L heavy-duty trailering package (2-speed transfer case is available)
TRANSMISSION	6-speed automatic, see engine, transmission and axle chart on page 4
WHEELS	See wheel and tire chart on page 5

4 | SUBURBAN COMMERCIAL FLEET - 1FL

COMMERCIAL FLEET PACKAGE OPTION 1FL

ENGINE/AXLE									
<i>S = Standard Equipment A = Available – (dashes) = Not Available</i>									
MODEL	ENGINE	TRANSMISSION		AXLE			GVWR lbs. (kg)		
		MYC 6-SPEED AUTOMATIC	MYD 6-SPEED AUTOMATIC HD	GU4 3.08	GU6 3.42	GT4 3.73	C5Z 7200 (3266)	C6C 7400 (3357)	C6P 8600 (3901)
CC10906	LMG Vortec 5.3L V8 SFI FlexFuel ²	S	—	S	A	—	S	—	—
CK10906	LC9 Vortec 5.3L V8 SFI FlexFuel ²	S	—	S	A	—	—	S	—
CC20906	L96 Vortec 6.0L VVT V8 SFI FlexFuel ²	—	S	—	—	S	—	—	S
CK20906	L96 Vortec 6.0L VVT V8 SFI FlexFuel ²	—	S	—	—	S	—	—	S

Note: Emission type must be ordered
FE9 - Federal YF5 - California NG1 - Northeast States

TRAILERING SPECIFICATIONS						
AUTOMATIC TRANSMISSION RATINGS WITH BALL HITCH						
MODEL	(LMG) VORTEC 5.3L V8 SFI FLEXFUEL²		(LC9) VORTEC 5.3L V8 SFI FLEXFUEL²		(L96) VORTEC 6.0L V8 GAS SFI FLEXFUEL²	
	AXLE RATIO	MAXIMUM TRAILER WEIGHT LBS.⁷ (KG)	AXLE RATIO	MAXIMUM TRAILER WEIGHT LBS.⁷ (KG)	AXLE RATIO	MAXIMUM TRAILER WEIGHT LBS.⁷ (KG)
CC10906	3.08	5100 (2313)	—	—	—	—
	3.42	5600 (2540)	—	—	—	—
CC10906*	3.42	8100 (3674)	—	—	—	—
CK10906	—	—	3.42	5500 (2495)	—	—
CK10906*	—	—	3.42	8000 (3629)	—	—
CC20906	—	—	—	—	3.73	9600 (4354)
CK20906	—	—	—	—	3.73	9400 (4264)

* with K5L

GCWR - ENGINE/REAR RATIO COMBINATION WITH AUTO TRANS			
ENGINE	(GCWR) GROSS COMBINATION WEIGHT RATINGS LBS. (KG)		
	11000 (4989)	14000* (6350)	16000 (7257)
(LMG) Vortec 5.3L V8 SFI FlexFuel ²	3.08	3.42	—
(LC9) Vortec 5.3L V8 SFI FlexFuel ²	—	3.42	—
(L96) Vortec 6.0L Variable Valve Timing V8 SFI FlexFuel ²	—	—	3.73

*with (K5L) heavy-duty Trailering Package

2. E85 is 85% ethanol and 15% gasoline. To see if there is an E85 station near you, go to www.gmaltfuel.com/e85-station-locator.

7. Maximum trailer weight ratings are calculated assuming a base vehicle, except for any option(s) necessary to achieve the rating, plus driver. The weight of other optional equipment, passengers and cargo will reduce the maximum trailer weight your vehicle can tow.

TIRES AND WHEELS

ROAD TIRES

CODE	SIZE	DESCRIPTION	SIDE WALL	USAGE	MODELS
QAN	P265/70R17	All-season	Blackwall	Standard	1/2 ton 2 or 4WD
QJP	P265/70R17	On/off-road	Blackwall	Optional	1/2 ton 4WD
QIZ	LT245/75R16E	All-season	Blackwall	Standard	3/4 ton 2WD
QIZ	LT245/75R16E	All-season	Blackwall	Optional	3/4 ton 4WD
QIW	LT245/75R16E	On/off-road	Blackwall	Standard	3/4 ton 4WD
QIW	LT245/75R16E	On/off-road	Blackwall	Optional	3/4 ton 2WD
QXT	LT265/70R17E	All-terrain	Blackwall	Optional	3/4 ton (requires P25 wheels)

SPARE TIRES

CODE	SIZE	DESCRIPTION	SIDE WALL	USAGE	MODELS
ZRS	P265/70R17	All-season	Blackwall	Standard	1/2 ton
ZIZ	LT245/75R16	All-season	Blackwall	Standard	3/4 ton
ZER	LT265/75R16E	On/off-road	Blackwall	Optional	3/4 ton (requires QXT tires)
4JP	P265/70R17	On/off-road	Blackwall	Optional	1/2 ton (requires QJP tires)
4GK	LT245/75R16E	On/off-road	Blackwall	Optional	3/4 ton 4WD (requires QIW tires)

ROAD WHEELS

CODE	SIZE	DESCRIPTION	SIDE WALL	USAGE	MODELS
NX7	17" x 7"	4 – steel	Steel	Standard	1/2 ton
P46	17" x 7.5"	4 – 5 spoke	Aluminum	Optional	1/2 ton
QB5	16" x 6.5"	4 – steel	Steel	Standard	3/4 ton
P25	17" x 7.5"	4 – 8 lug	Aluminum	Optional	3/4 ton

SPARE WHEELS

CODE	SIZE	DESCRIPTION	SIDE WALL	USAGE	MODELS
NZ4	17"	One – steel	Steel	Standard	1/2 ton
NZ3	16"	One – steel	Steel	Standard	3/4 ton

Note: Polished forged aluminum, includes chrome center caps and steel spare

SEATS AND INTERIOR TRIM

S = Standard Equipment A = Available -- (dashes) = Not Available

DECOR LEVEL	SEAT TYPE	SEAT CODE	SEAT TRIM	INTERIOR		
				EBONY	LIGHT TITANIUM/ DARK TITANIUM ¹	DARK CASHMERE/ LIGHT CASHMERE ¹
STANDARD COMMERCIAL (1FL)	Front: 40/20/40 reclining split-bench	AZ3	Premium cloth	19C	33C	—
AVAILABLE COMMERCIAL (1FL)	Front: 40/20/40 reclining split-bench	AZ3	Vinyl	19V	—	—
OPTIONAL COMMERCIAL (1FL)	Front: high-back reclining bucket	A95	Premium cloth	19C	33C	—

EXTERIOR SOLID PAINT	COLOR CODE	TOUCH UP PAINT NUMBER	INTERIOR		
			EBONY	LIGHT TITANIUM/ DARK TITANIUM [†]	DARK CASHMERE/ LIGHT CASHMERE [†]
Black	41U	WA-8555	A	A	A
Mocha Steel Metallic	GHA	WA-7065	A	A	A
Summit White	50U	WA-8624	A	A	A
Gold Mist Metallic	51U	WA-316N	A	—	A
Silver Ice Metallic	GAN	WA-636R	A	A	A
Black Granite Metallic	58U	WA-501Q	A	A	A
Crystal Red Tintcoat	89U	WA-505Q	A	A	A

[†] - Interior color has lighter/darker two-tone effect.

AVAILABLE EXTERIOR COLORS



51U

Gold Mist
Metallic



6AN

Silver Ice
Metallic
(Extra Cost)



41U

Black



6HA

Mocha Steel
Metallic



50U

Summit White



58U

Black Granite
Metallic
(Extra Cost)











89U

Crystal Red
Tintcoat
(Extra Cost)

Actual colors may vary

SEO PAINT AVAILABLE

WA#	COLOR DESCRIPTION	CODE
334D	Dark Toreador Red 	
253A	Wheatland Yellow 	9W3
722J	Dark Blue Metallic 	9V7
5665	Blue 	
7941	Green 	
9015	Woodland Green 	9V5
9260	Victory Red 	Requires SEO 5T4
9414	Yellow 	

ACTUAL COLOR MAY VARY

Note: - All normally body-colored, non-sheet metal parts, will be Flat Black (except Victory Red non-sheet metal parts will match)
 - SEO paint orders that contain less than five vehicles will be delayed until five unit minimum is received for batch production

AVAILABLE OPTIONS

K47	AIR CLEANER - High capacity
KW1	ALTERNATOR - 160-amps (standard on 1/2 ton models; included and only available with VYU Snow Plow Prep Package on 4-wheel drive 3/4 ton models; not available on 2-wheel drive 3/4 ton model)
JL1	BRAKE CONTROLLER - Integrated trailer
D07	CONSOLE - Floor storage area and cup holders (included and only available with A95 front custom cloth bucket seats)
UTQ	CONTENT THEFT ALARM DISABLE - Flashing lamps and horn warning
KNP	COOLING - Auxiliary transmission oil cooler (standard on 3/4 ton. Included and only available with K5L HD Trailerling Package ⁷ on 1/2 ton)
KC4	COOLING - External engine oil cooler (standard on 3/4 ton. Included and only available with K5L HD Trailerling Package ⁷ on 1/2 ton)
G80	DIFFERENTIAL - Heavy-duty locking rear
K05	ENGINE BLOCK HEATER
B30	FLOOR COVERING - Color-keyed carpeting (includes B58 color keyed floor mats)
VAV	FLOOR MATS, ALL WEATHER - First and second row, requires B30 color-keyed carpeting. Not available with AZE front 40/20/40 split-bench on 2WD models. (LPO, dealer installed)
VKN	FLOOR MATS, ALL WEATHER - Third row, requires B30 color-keyed carpeting and AS3 third row 50/50 split-bench seats. Not available with AZE front 40/20/40 split-bench on 2WD models. (LPO, dealer installed)
T96	FOG LAMPS - Front, halogen
ANJ	GLASS - Non-deep tinted
K5L	HEAVY-DUTY TRAILERING PACKAGE⁷ - Includes auxiliary transmission oil cooler and external engine oil cooler, (1/2 ton model only. Includes 3.42 ratio rear axle)
V1K	LUGGAGE RACK CENTER RAILS - Roof mounted, Black
G63	LUGGAGE RACK - Delete
VLI	MAT, REAR CARGO - Requires B30 color-keyed carpeting. Not available with ATD third row seat delete. (LPO, dealer installed)
B58	MATS - Color-keyed carpeted first and second row, removable (included and only available with B30 floor covering)
DPN	MIRRORS - Outside heated power-adjustable vertical camper; manual-folding, extension and integrated turn signal indicators
UEO	ONSTAR - Delete
VBS	REMOTE, 2-WAY ADVANCED - (LPO, dealer installed)
AP3	REMOTE VEHICLE STARTER SYSTEM - Includes remote keyless entry
UD7	REAR PARKING ASSIST - Ultrasonic with led display and audible warning (requires JF4 power-adjustable pedals)
V76	RECOVERY HOOKS - Front, frame mounted (standard on 3/4 ton models)
TRW	ROOF MOUNTED LAMP - Provisions (included with VYU Snow Plow Prep Package)
NZZ	SKID PLATE PACKAGE - Requires 4-wheel drive model, includes aluminum front underbody shield starting behind front bumper and running to first cross-member, protecting front underbody, oil pan, differential case and transfer case, frame-mounted shield, requires 4-wheel drive model
VYU	SNOW PLOW PREP PACKAGE - 4-wheel drive 3/4 ton models, includes instrument panel switch, roof beacon wiring, forward lamp wiring and torsion bar (includes TRW roof mounted lamp provisions)
NQH	TRANSFER CASE - Active 2-speed electronic autotrac with rotary controls includes neutral position for dinghy towing, requires 4WD models included with K5L heavy-duty trailer package or 3/4 ton models

SPECIAL EQUIPMENT OPTIONS AVAILABLE

6C5	BATTERY - Single Heavy Duty 730 cca
5T4	EXTERIOR BODY-COLORED PARTS - Victory Red with special paint WA9260; Victory Red painted front and rear fascias, rear liftgate handle and rear license plate applique, body side moldings and door handles. Required with Victory Red special paint WA9260
9N5	FLOOR CONSOLE DELETE - Deletes floor console and associated audio equipment that is included with premium cloth high-back buckets seats; requires: PEG 1FL and RPO A95 bucket seats
8X1	LABEL, FASTEN SAFETY BELTS - On Left hand and right hand front door window glass

7. Maximum trailer weight ratings are calculated assuming a base vehicle, except for any option(s) necessary to achieve the rating, plus driver. The weight of other optional equipment, passengers and cargo will reduce the maximum trailer weight your vehicle can tow.

SPECIAL EQUIPMENT OPTIONS AVAILABLE (CONTINUED)

9G3	OFF-ROAD SUSPENSION - Off-road suspension 4x4 commercial or low uplevel décor; includes Z71, off-road suspension components, skid plate and high capacity air cleaner; does not include body side "Z71" decals; requires: model K10906 option QJP P265/75R17 on-off road tires PEG 1FL Suburban 1LS or 1LT Uplevel Package and a fleet or government type order
5T5	SEATS, CLOTH FRONT VINYL REAR - Vinyl 2nd row rear seats and cloth front seats; if AS3 third row seat is ordered, it will be vinyl. Requires: AZ3 front custom cloth 40/20/40 bench seat or A95 front custom cloth high-back bucket seat, trim code 19D Ebony and PEG 1FL
9S1	SEATS, DRIVER AND PASSENGER FRONT INDIVIDUAL SEATS IN VINYL TRIM - Derived from RPO AE7 40/20/40 split-bench with center 20% section removed; seats are manual, not power; does not include floor console; exposed floor areas will remain untrimmed; rear seats will also be vinyl trimmed; requires trim code 19V Ebony and PEG 1FL
9V7	EXTERIOR BODY COLOR PARTS - Dark blue metallic see Keith Switzer for Details

EMISSIONS - MUST BE SPECIFIED

FE9	FEDERAL EMISSIONS. Use for ordering vehicles that will be registered in all states except California, Connecticut, Maine, Maryland, Massachusetts, New Jersey, New Mexico, New York, Oregon, Pennsylvania, Rhode Island, Vermont and Washington State
YF5	CALIFORNIA EMISSIONS. Use for ordering vehicles that will be registered in California.
NE1	CT/ME/MD/MA/NJ/NM/NY/OR/PA/RI/VT/WA EMISSIONS. Use for ordering vehicles that will be registered in Connecticut, Maine, Maryland, Massachusetts, New Jersey, New Mexico, New York, Oregon, Pennsylvania, Rhode Island, Vermont or Washington State
NB8	Required when option code FE9 "FEDERAL EMISSIONS" is ordered for delivery to a dealer located in California, Connecticut, Massachusetts, Maryland, New Jersey, New Mexico, New York, Oregon, Pennsylvania, Rhode Island and Washington State for a purchaser who will be registering the vehicle outside California, Connecticut, Maine, Maryland, Massachusetts, New Jersey, New Mexico, New York, Oregon, Pennsylvania, Rhode Island, Vermont and Washington State.
NC7	Required when option code YF5 "CALIFORNIA EMISSIONS" or option code NE1 "CT/ME/MD/MA/NJ/NM/NY/OR/PA/RI/VT/WA EMISSIONS" is ordered for delivery to a dealer located in any state except California, Connecticut, Maine, Maryland, Massachusetts, New Jersey, New Mexico, New York, Oregon, Pennsylvania, Rhode Island, Vermont and Washington for a purchaser who will be registering the vehicle in one of these states or sold as permitted below under "EPA Policy on the Sale of California Emission Vehicles"
NB9	Required when option code YF5 is ordered for delivery to a dealer located in Connecticut, Maine, Maryland, Massachusetts, New Jersey, New Mexico, New York, Oregon, Pennsylvania, Rhode Island, Vermont and Washington. Required when option code NE1 is ordered for delivery to a dealer located in California.

	CC10906 2WD 1/2 Ton	CK10906 4x4 1/2 Ton	CC20906 2WD 3/4 Ton	CK20906 4x4 3/4 Ton
SPECIFICATIONS (in./mm)				
Wheelbase	130.0/3302	130.0/3302	130.0/3302	130.0/3302
Overall length	222.4/5649	222.4/5649	222.4/5649	222.4/5649
Body width	79.1/2009	79.1/2009	79.1/2009	79.1/2009
Overall height	76.8/1951	76.8/1951	76.8/1951	76.8/1951
Head room, front	41.1/1044	41.1/1044	41.1/1044	41.1/1044
Head room, center	38.5/978	38.5/978	38.5/978	38.5/978
Head room, rear	38.1/968	38.1/968	38.1/968	38.1/968
Shoulder room, front	65.3/1659	65.3/1659	65.3/1659	65.3/1659
Shoulder room, center	65.2/1656	65.2/1656	65.2/1656	65.2/1656
Shoulder room, rear	64.7/1643	64.7/1643	64.7/1643	64.7/1643
Hip room, front	60.5/1537	64.4/1636	64.4/1636	64.4/1636
Hip room, center	61.8/1570	61.8/1570	61.8/1570	61.8/1570
Hip room, rear	49.4/1255	49.4/1255	49.4/1255	49.4/1255
Leg room, front	41.3/1049	41.3/1049	41.3/1049	41.3/1049
Leg room, center	39.5/1003	39.5/1003	39.5/1003	39.5/1003
Leg room, rear	34.9/886	34.9/886	34.9/886	34.9/886
Ground to top of rear load floor	31.8/808	32.6/828	31.8/808	32.6/828
Load floor length, to front seat, at floor	101.8/2586	101.8/2586	101.8/2586	101.8/2586
Load floor length, to center seat, at floor	69.6/1768	69.6/1768	69.6/1768	69.6/1768
Load floor length, to rear seat, at floor	35.6/904	35.6/904	35.6/904	35.6/904
Inside width, between wheelhousing	49.1/1247	49.1/1247	49.1/1247	49.1/1247
Cargo area height	41.4/1052	41.4/1052	41.4/1052	41.4/1052
Ground clearance, front	10.5/267	10.5/267	10.5/267	10.5/267
Ground clearance, rear	9.1/231	9.1/231	9.1/231	9.1/231
Front shock absorber diameter	1.81/46	1.81/46	1.38/35	1.38/35
Front stabilizer bar diameter	1.41/36	1.41/36	1.40/36	1.40/36
Rear shock absorber diameter	1.81/46	1.81/46	1.38/35	1.38/35
Rear stabilizer bar diameter	1.10/28	1.10/28	—	—
Turning diameter, curb-to-curb, ft. (m)	43.0/13.1	43.0/13.1	45.3/13.8	45.3/13.8
CAPACITIES lbs. (kg)				
Front axle	3500/1588	3600/1633	3800/1724	4180/1896
Rear axle	4200/1905	4200/1905	5500/2495	5500/2495
Curb weight	5846/2652	6024/2732	6215/2819	6551/2971
Cargo volume ³ , cu. ft. (liters)	137.4/3891.2	137.4/3891.2	137.4/3891.2	137.4/3891.2
Payload ⁶	1519/689	1563/709	2429/1102	2162/981
Gross Vehicle Weight Rating ⁵ (GVWR)	7200/3266	7400/3357	8600/3901	8600/3901
Front Gross Axle Weight Rating (FGAWR)	3500/1588	3600/1633	3800/1724	4180/1896
Rear Gross Axle Weight Rating (RGAWR)	4200/1905	4200/1905	5500/2495	5500/2495
Fuel capacity, approximate, gallon (liters)	31/117	31/117	39/148	39/148
Seating capacity (front/center/rear)	3/3/3	3/3/3	3/3/3	3/3/3
<i>Note: Published dimensions indicated are without optional equipment or accessories. Additional accessories or equipment ordered at the customer's request can result in a minor change in these dimensions.</i>				

3. Cargo and load capacity limited by weight and distribution.

5. Gross Vehicle Weight Rating (GVWR). When properly equipped, includes vehicle, passengers, cargo and equipment.

6. Maximum payload capacity includes weight of driver, passengers, optional equipment and cargo.

Can specialty vehicle equipment (e.g. radar devices, video cameras, computers, meters, radio trees, shotguns, etc.) still be mounted in cars with passenger side air bags?

Yes, but care must be taken to mount the equipment outside of the deployment zone. Air bags inflate with great force and will interact with any object in the deployment zone. Therefore, to reduce the risk of injury to vehicle occupants, GM recommends that the air deployment zone be kept free of any equipment. If a piece of equipment were to become dislodged it could strike an occupant in the vehicle and result in injury. The likelihood of an object becoming dislodged is influenced by many factors, including the proximity of the object to the inflatable restraint, the size and shape of the object, and the means by which the object is secured to the vehicle. In addition to these factors, the trajectory and velocity of a dislodged object can be influenced by the type and severity of vehicle crash.

Objects that are in the deployment zone, but do not become dislodged by an inflating air bag can still affect the performance of the air bag. For example, such objects could tear the fabric or affect the shape of the air bag, thus reducing the ability of the bag to provide restraint.

Is it possible to shield equipment that is installed in the passenger side frontal air bag deployment zone in a manner that will allow full and safe air bag deployment?

Due to the complexity of influencing variables, GM is unable to evaluate the potential for shielding expected equipment configurations in all accident scenarios in order to assure that the air bag performance would be unaffected. While shielding may protect certain equipment from being damaged or dislodged, it may also negatively affect the inflation characteristics of the air bag. The air bag's shape, inflation angle, fold pattern, and inflation rate and pressure are developed to maximize the protection capability of the inflatable restraint system. Therefore, GM cannot recommend the placement of any equipment in the deployment zone, even if it is shielded to protect it from damage.

Front air bag systems and instrument panel mounted equipment.

Passenger air bags in GM vehicles deploy in different ways depending upon the type of vehicle and the particular instrument panel design.

In some vehicles, the passenger air bag deploys through a discrete door located on the top surface of the instrument panel (top-mount air bag systems). In other vehicles, such as the Chevrolet Tahoe, the passenger air bag deploys through a discrete door mounted on the vertical rearward surface of the instrument panel, above the glove box door (mid-mount air bag system). With these types of top-mount and mid-mount passenger air bag systems, the top pad of the instrument panel remains in place during deployment.

Some GM passenger air bag systems, like the system in the Chevrolet Impala, deploy from beneath the instrument panel top pad. These are considered 3/4-mount air bag systems with a "deployable top pad." The entire instrument panel top pad is the "deployment door" from under which the inflating air bag emerges. When an air bag deployment is commanded, the forces from the inflating passenger air bag push up on the instrument panel top pad, releasing special fasteners across the rearward edge of the top pad. This allows the top pad to rotate upward so that the passenger air bag may emerge. The top pad rotates upward to open widest at the right hand side, and is usually forced upward into contact with the windshield on the right hand side of the vehicle during a deployment.

Head curtain side air bags are designed to help reduce the risk of head and neck injuries to front and rear seat occupants on the near side of certain side-impact collisions. Always use safety belts and the correct child restraints for your child's age and size, even in vehicles equipped with air bags. Children are safer when properly secured in a rear seat. See your vehicle Owner's Manual and child safety seat instructions for more information.

Instrument panel top mounted special equipment, such as a radar antenna and control unit or video camera must be positioned to the left of the vehicle center line. This equipment must be mounted as low as possible and securely fastened to the top pad to avoid being dislodged in the event of a crash and possible air bag deployment. In the process of securely fastening special equipment to the top, DO NOT fasten down the top pad itself to any other vehicle component such as the cluster trim plate. As described above, the top pad rotates upward during a deployment. In order to enable the proper deployment of the passenger air bag, specialty equipment installation MUST NOT PREVENT the top pad from rotating upward during deployment. Location and attachment of special equipment should minimize added resistance or interference to upward rotation of the top pad during deployment.

Optional side air bags for crashes to the vehicle sides.

The air bag system in your police vehicle may include optional side air bags for front and rear occupants. Most front-to-rear side air bags are designed to deploy downward from the interior roof sides to the bottom of the door windows.

Can Specialty Vehicle Security Barriers be mounted within the side air bag deployment zones?

No. The side air bags inflate extremely fast because of the nature of side crashes to the vehicle. Mounting a security barrier behind the front seats with the ends placed within the side air bag deployment zones will result in unintended interaction between the barrier and the inflating side air bags. To reduce the risk of injury to the vehicle occupants, GM recommends that the side air bag zones be kept free of any customer installed equipment.

Customer furnished equipment installed to the vehicle roof.

Your police vehicle is designed with an interior roof cover system which includes internal components for the interior lamps and wiring. The roof system may also include optional side air bag components. Inflation devices may be mounted on the vehicle roof side behind the rear doors as well as air bag tethers retained to the windshield pillars. Care must be taken to avoid damage to these components or interference with their operation when installing roof mounted equipment such as emergency lamps and communication antennas.

Recommended GM service procedures must be followed to remove and re-install the instrument panel top pad to ensure that the top pad will release properly in the event of a passenger air bag deployment.

On the right half of the top pad closest to the passenger air bag module, GM recommends that no equipment be mounted. When mounting equipment on the driver side of the top pad, GM recommends that the total mass of the top pad mounted special equipment not exceed 8 pounds (3.6 kilograms), since the top pad tends to rotate about the left end.

Fasteners used to secure special equipment to the instrument panel top pad, the windshield glass, or to the windshield upper frame (header), should be selected to ensure that these devices will remain attached during a vehicle crash and possible air bag deployment.

Can the installation of push bumpers on the front end of the vehicle affect the deployment of the air bag?

General Motors is not aware of adverse effects during crash events from the many push bumpers that have been installed on GM police vehicles. Because there are many styles of push bumpers available with varying crash characteristics, installation of push bumpers may or may not affect deployment timing of the air bags. Push bumpers should be mounted to avoid modifying the vehicle structure and interfering with the front air bag sensors mounted on the upper radiator support cross member.

Two front impact sensors are installed in General Motors vehicles. Do not relocate or disconnect the front sensors. The location and orientation of the front sensors are critical for correct operation of the air bag system. Avoid mounting components on or near the sensors. Push bumper styles with vertical pushing members that are in fore-aft alignment with the front air bag sensors are not recommended.

How long will the air bag remain inflated?

It takes approximately 1/20th of a second to fully inflate the frontal air bags. This is faster than the blink of an eye. The air bags begin to deflate immediately, helping to stop the occupants more gradually.

Can the air bag system be re-used?

No. The air bags are designed to inflate only once. After inflation some new parts will be required. These will include the air bag module and possibly other parts. (A competent service technician with access to the vehicle's service manual and the required tools should replace the required components after a deployment crash.)

I've heard that the dusts that are released into the passenger compartment from the air bag are harmful. Is this true?

For most people, the only effect the dusts will produce is some irritation of the throat and eyes, and that is only if the occupant remains in the vehicle for many minutes after the air bag deployment with no ventilation and windows closed. However, some people with asthma may develop an asthmatic attack from inhaling the dusts. If this happens, they should first treat themselves the same way their doctor has advised them to treat any other asthma attack, and then immediately seek medical treatment.

When should an air bag inflate?

The driver's and right-front passenger's frontal air bags are designed to inflate in moderate to severe frontal or near-frontal crashes. But they are designed to inflate only if the impact speed is above the system's designed "threshold level."

In addition, if your vehicle has "dual stage" frontal air bags, these air bags tailor the amount of restraint according to crash severity. For moderate frontal impacts, the air bags inflate at a level less than full deployment. For more severe frontal impacts, "dual stage" frontal air bags deploy at full levels.

If the front of your vehicle goes straight into a wall that doesn't move or deform, the threshold level of the reduced deployment is about 12 to 16 mph (19 to 15 km/h), and the threshold level for a full deployment is about 18 to 24 mph (29 to 28.5 km/h). The threshold level can vary, however, with specific vehicle design, so that it can be somewhat above or below this range.

If your vehicle strikes something that will move or deform such as a parked car, the threshold level will be higher. The driver's and right-front passenger's frontal air bags are not designed to inflate in rollover, side impacts, or rear impacts, because inflation would not help the occupant.

Head curtain side air bags are designed to help reduce the risk of head and neck injuries to front and rear seat occupants on the near side of certain side-impact collisions. Always use safety belts and the correct child restraints for your child's age and size, even in vehicles equipped with air bags. Children are safer when properly secured in a rear seat. See your vehicle Owner's Manual and child safety seat instructions for more information.

Seat mounted side impact air bags are designed to inflate in moderate to severe side crashes. The side impact air bags will inflate if the crash severity is above the designed "threshold level." The threshold level can vary with specific vehicles design. The side impact air bags are not designed to inflate on frontal or near-frontal impacts or rear impacts, because inflation would not help the occupant.

Roof rail mounted head-curtain air bags are designed to inflate in moderate to severe side crashes. In addition, certain vehicles have head-curtain air bags which are also designed to inflate in situations where an impending rollover condition is identified by the vehicle's rollover sensing system and/or frontal or near-frontal impacts if the crash severity is above the designed "threshold level".

Safety belt pretensioners at the driver and front passenger seat positions are designed to deploy in frontal, near-frontal, side, and rear crashes that exceed the "threshold level" of crash severity to help reduce slack in the safety belt. Safety belt pretensioners will also deploy in impending rollover situations.

I've heard that a deployed air bag produces what appears to be smoke. Is the air bag hot?

After the bag has deployed in a crash, the air bag itself will not be hot to touch. Some components within the air bag module will be hot for a short time. A small amount of smoke coming from a deployed air bag module is normal and should not be cause for concern.

Also, when the nitrogen gas is vented out of the air bag, small particles from inside the bag are also vented into passenger compartment. These airborne particles look like smoke and some particles are deposited as residue on and around the air bag.

If my vehicle has air bags, why should I have to wear my safety belt?

Air bags are in many vehicles today and will be in most of them in the future. But they are supplemental systems only; so they work with safety belts - not instead of them. Every air bag system ever offered for sale has required the use of safety belts. Even if you're in a vehicle that has air bags, you still have to buckle up to get the most protection. That's true not only in frontal collisions but especially in side and other collisions.

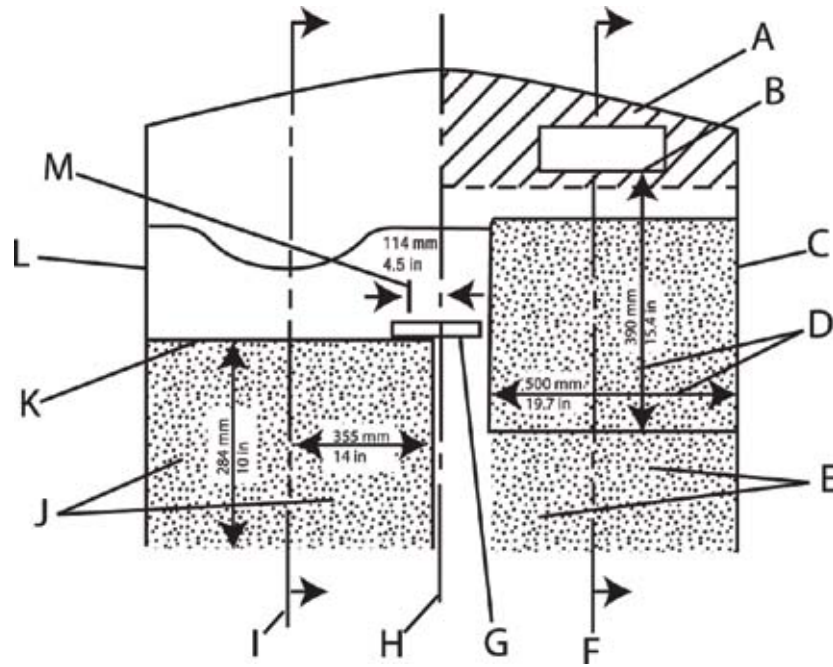

TOP VIEW OF INSTRUMENT PANEL AND APPROXIMATE DEPLOYMENT AREA OF THE AIR BAG ZONE

- A. Passenger side instrument panel top surface zone
- B. Passenger side air bag module trim panel – rear edge
- C. Passenger side door
- D. Approximate dimensions of inflated air bag
- E. Passenger side air bag deployment zone
- F. Passenger centerline
- G. Inside rearview mirror
- H. Vehicle centerline
- I. Driver centerline
- J. Driver side air bag deployment zone
- K. Front of steering wheel
- L. Driver side door
- M. Shift selector arc

Head curtain side air bags are designed to help reduce the risk of head and neck injuries to front and rear seat occupants on the near side of certain side-impact collisions. Always use safety belts and the correct child restraints for your child's age and size, even in vehicles equipped with air bags. Children are safer when properly secured in a rear seat. See your vehicle Owner's Manual and child safety seat instructions for more information.

Note: All dimensions are approximate and subject to change.

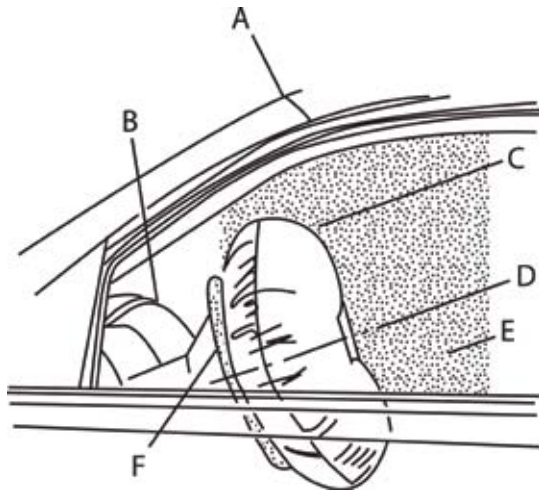

SIDE VIEW OF DRIVER SIDE
AIR BAG DEPLOYMENT ZONE

- A. Top edge of windshield
- B. Top of instrument panel
- C. Inflated air bag – steering wheel
- D. Centerline of steering column at mid-tilt
- E. Driver air bag deployment zone
- F. Front of steering wheel

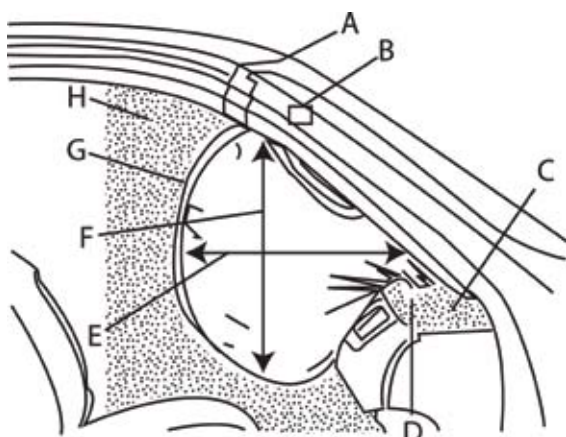

SIDE VIEW OF PASSENGER SIDE AIR BAG
DEPLOYMENT ZONE

- A. Top edge of windshield
- B. Inside rearview mirror
- C. Instrument panel top surface zone
- D. Passenger side air bag module trim panel – rear edge
- E. Inflated air bag – horizontal dimension approximate 15.4 in (390 mm)
- F. Inflated air bag – vertical dimension approximate 9.3 in (490 mm)
- G. Inflated air bag – instrument panel
- H. Passenger air bag deployment zone

Head curtain side air bags are designed to help reduce the risk of head and neck injuries to front and rear seat occupants on the near side of certain side-impact collisions. Always use safety belts and the correct child restraints for your child's age and size, even in vehicles equipped with air bags. Children are safer when properly secured in a rear seat. See your vehicle Owner's Manual and child safety seat instructions for more information.

Note: All dimensions are approximate and subject to change.

HEAD CURTAIN AND FRONT SEAT-MOUNTED SIDE IMPACT AIR BAG DEPLOYMENT ZONES PASSENGER SIDE SHOWN, DRIVER SIDE SIMILAR

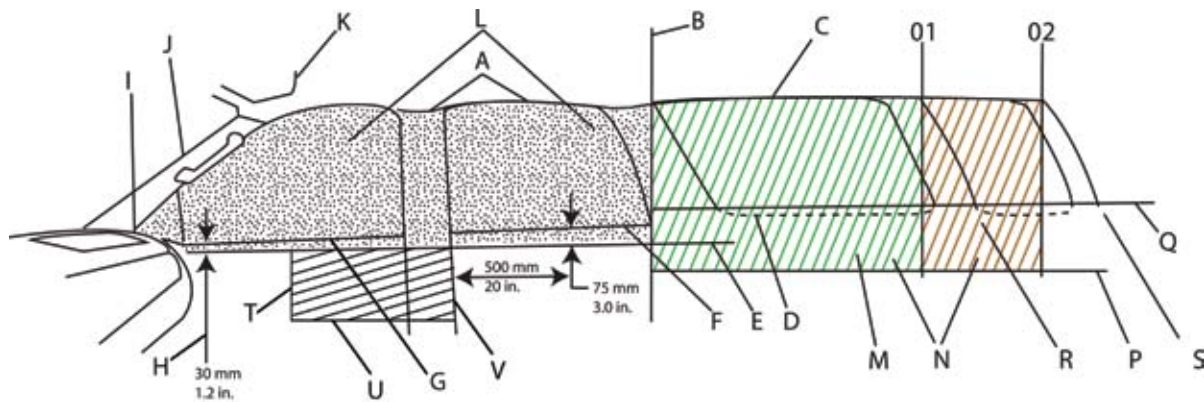

Tahoe/Suburban/Silverado Crew Cab Seat Rows 1 and 2

- A. Top of deployment zone – along head curtain at edge of headliner
- B. Back of deployment zone – at rear top corner of rear door pad
- C. Rear quarter window
- D. Bottom outside edge of rear quarter window
- E. Bottom of air bag deployment zone – parallel to outside bottom edge of rear quarter glass
- F. Top edge of rear door pad
- G. Top edge of front door pad
- H. Dimension at mirror patch from top edge of front door pad
- I. Front of deployment zone at front upper corner of front door pad
- J. Windshield pillar trim with grab handle
- K. Visor
- L. Deployment zone - Tahoe seat rows 1 and 2

Tahoe/Suburban 3rd Row Seats

- M. Deployment zone - Tahoe 3rd seat
- N. Deployment zone - Suburban 3rd seat
- O. Rear zones at back corner of headliner: 1 Tahoe, 2 Suburban
- P. Bottom of 3rd seat zone at rear side trim cup holders
- Q. Top edge of rear quarter trim at window
- R. Rear of Tahoe
- S. Rear of Suburban

Tahoe/Suburban/Silverado Crew Cab Seat Air bag

- T. Center of door trim pull handle
- U. Top of surface of outboard front seat cushion
- V. Back edge of center pillar trim

Note: The head curtain air bag inflators are mounted in a different orientation on the Silverado Crew Cab pickup truck roof structure from those in the Tahoe/Suburban.

HEAD CURTAIN AND FRONT SEAT-MOUNTED SIDE IMPACT AIR BAG DEPLOYMENT ZONES VIEW FROM REAR CARGO AREA

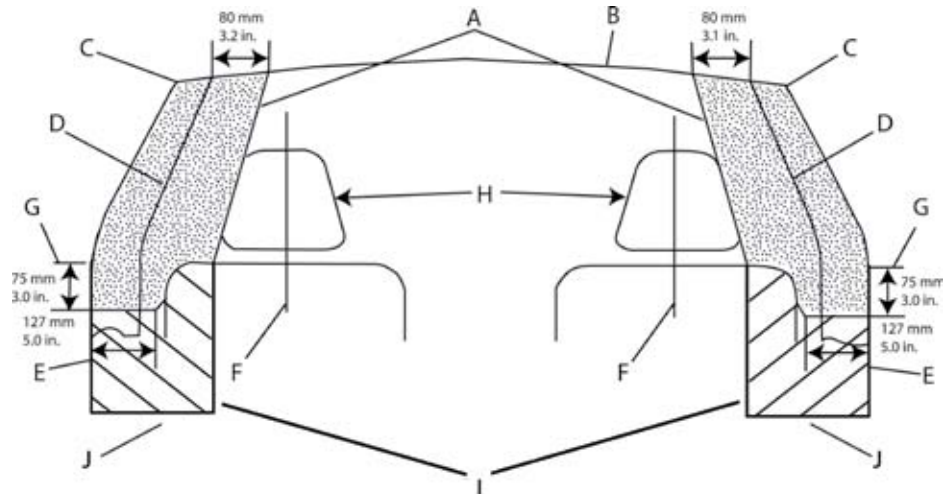

- A. Head curtain air bag deployment zone
- B. Underside of headliner
- C. Edge of headliner
- D. Inner center pillar trim
- E. Inner door pad
- F. Seat centerline
- G. Bottom of door windows
- H. Front seat headrests
- I. Seat-mounted side impact air bags deployment zone front seat
- J. Top surface of outboard front seat cushion

Head curtain side air bags are designed to help reduce the risk of head and neck injuries to front and rear seat occupants on the near side of certain side-impact collisions. Always use safety belts and the correct child restraints for your child's age and size, even in vehicles equipped with air bags. Children are safer when properly secured in a rear seat. See your vehicle Owner's Manual and child safety seat instructions for more information.

Note: All dimensions are approximate and subject to change.

GM offers Anti-Lock Brake Systems as standard or optional on all North American passenger vehicles and light truck lines. The computerized Anti-Lock Braking System (ABS) is designed to keep the vehicle's wheels rotating as the brakes are applied to assist the driver in achieving a controlled stop. Sensors monitor how fast the wheels rotate and feed the data continuously to the ABS computer. The vehicle's brakes slow each wheel as the brake pedal is applied. However, when ABS is activated due to road conditions, the system repeatedly releases and applies pressure to the brakes. The wheels can keep rolling, thus retaining steering ability and enhanced stability while providing a higher braking force on most surfaces than a locked wheel provides.

How exactly does ABS work?

In cars without ABS, hitting the brakes can cause the wheels to lock, leaving you unable to steer the vehicle until you decrease the pressure so the wheels can roll again. With an ABS, as you apply the brakes, the ABS computer monitors the wheel speed sensor information. If the computer senses that a wheel is approaching lock up, it sends a signal to the hydraulic modulator to reduce, then to reapply, brake pressure several times a second for as long as you maintain firm pressure on the brake pedal. The process is much like the threshold braking technique used with conventional brakes. However, ABS does it much faster and more accurately than any driver can, leaving you free to focus on steering away from obstacles.

Does ABS reduce stopping distances?

Yes, in braking situations where the wheels on a non-ABS equipped vehicle would lock up, ABS will generally provide shorter controlled stopping distance. The amount of improvement in stopping distance depends on many factors, including the road surface, severity of braking, initial vehicle speed, etc. On some surfaces, such as gravel roads, braking distances can be longer, but you will still have the control benefits of ABS. The important capability of ABS is control. ABS provides improved vehicle steerability and stability when braking.

What can affect the ABS advantage?

It is important that you follow the maintenance schedule recommended in the owner's manual of the vehicle, tires should be at their proper inflation level, the brake pads should be checked regularly, etc. While driving, you should sit comfortably, so that your hips are back in the seat and your knees are bent, even while braking. Your foot should be positioned so that your heel is on the floor and your toes are secure on the lower half of the pedal. And, though ABS may reduce stopping distance, remember: The faster you go, the longer it takes you to stop. Keeping a safe distance between you and the vehicle in front of you is always necessary, even with ABS.

What happens if ABS becomes inactive?

The ABS electronic control unit has on-board diagnostic capability. If a fault is detected, the vehicle will revert to the base brake system, and the ABS telltale on the dash will be illuminated. Should this happen, the vehicle should be taken to a dealership for repair as soon as possible.

How do I use ABS?

Depress and hold the pedal. DO NOT PUMP THE BRAKES (that prevents the system from working). Just hold the brake pedal down and let the ABS work for you. You may feel the brake pedal vibrate, or you may notice some noise, but this is normal as the system works for you.

Should I drive an ABS equipped vehicle differently than I would drive a vehicle with conventional brakes?

Most of the time, under normal driving circumstances, there is no difference, and you should always drive with the same caution and care. It is important to realize that ABS only makes a difference when it is activated—when you have to brake hard—and that would only be when the computer senses that a wheel is approaching lock up. When ABS activates keep steady pressure on the brake pedal and then let the ABS work for you. Don't pump the brakes or try to find the threshold. Simply hold the brake pedal down and steer if necessary to avoid an obstacle.

Is ABS always active?

ABS is always available, but not always activated. ABS is activated only when the brake pedal is applied and the computer detects an impending wheel lock condition.

Can older cars be retrofitted with ABS?

No! The brake system is one of the most important features on any passenger vehicle. Several products, which tap into the master cylinder and/or brake system performance, are being sold in the aftermarket. Some of these products imply performance similar to new vehicle anti-lock brake systems.

However, contrary to their claims, add-on systems, which deplete fluid from the master cylinder on brake apply may actually increase a vehicle's stopping distance. This may cause the vehicle to fail to comply with Federal brake standards.

Does ABS always activate at the same speed?

No, the system operates when the computer detects wheel lockup, at any speed above 8 mph.

Will ABS wear out a vehicle's brakes sooner?

A properly maintained brake system will be unaffected by ABS operation under typical driving conditions.

Are there different types of ABS?

Yes, there are rear wheel anti-lock systems (RWAL) used on some trucks and four-wheel ABS available on cars and trucks.

Do Federal Safety Standards mandate ABS?

No. Federal standards establish minimum braking performance requirements that all vehicles must meet, but do not specify how they should be met. It should be noted that even a vehicle with failed ABS meets the Federal safety standard for stopping distances.

Will a tire size change affect ABS?

Use of tires other than original equipment may affect ABS performance. Owners should consult and follow the recommendations contained in the vehicle owner's manual regarding replacement tire size. *Note: ABS will work with original equipment spare tire or tire chains. However, performance is reduced.*

Do insurance companies give a discount for ABS?

Yes, many insurance companies give discounts that range from 5% to 10%. In the states of New York and Florida all insurance companies are required to give an ABS discount of 5% on certain coverages such as bodily injury, property damage, collision, and personal injury protection. In other states the discount varies from insurance company to insurance company. When buying auto insurance, always ask your insurance agent if his/her company gives a discount for vehicles equipped with anti-lock brakes.



IMPORTANT DRIVING SAFETY TIPS



- A. Always maintain a safe following distance.** ABS does not allow you to stop on a dime. (Generally a 2-second following distance is considered safe in ideal conditions.) Watch the vehicle in front of you pass a fixed marker (such as a sign). Count seconds—one-thousand-one, one-thousand-two—until your front bumper reaches the marker. If you do not count out two seconds, then you are too close to the vehicle in front of you. Also, if the roads are wet or icy, or visibility is poor, you should increase your following distance.
- B. Always drive carefully—** especially on slippery surfaces. ABS cannot create friction between the tires and the road surface, it can only give the driver the maximum advantage of the existing adhesion. If the vehicle is traveling on a surface with no adhesion, the best ABS in the world cannot provide a shorter stopping distance or good steering.
- C. It is a good idea to practice an ABS activated stop** and get the feel of the brake pedal. However, please make sure it's at a safe time with no obstacles in your path. And you only really need to try it once or twice to know what happens.

ELECTRONIC STABILITY CONTROL SYSTEMS (STABILITRAK)

StabiliTrak systems help drivers maintain control of their vehicles, especially during emergency lane changes or avoidance maneuvers. StabiliTrak uses various sensors, such as steering wheel angle, wheel speed, yaw velocity, etc., to detect any difference between the path requested by the steering wheel position and vehicle's actual path. When appropriate, the system selectively controls brakes, engine power, and even suspension settings to enhance control of the vehicle's direction and help keep it on course. Independent studies conducted by the National Highway Traffic Safety Administration, the Insurance Institute for Highway Safety, and others have found StabiliTrak to be highly effective in reducing vehicle crashes. General Motors offers StabiliTrak systems on many of its passenger car and light truck models. See your owner's manual for additional information about the operation of StabiliTrak.

Q. How do I use StabiliTrak?

A. StabiliTrak operates independently of the driver. You should continue to drive your StabiliTrak equipped vehicle with caution and care. GM's StabiliTrak system, StabiliTrak, is designed to be as seamless as possible in operation, to be part of the overall vehicle response and to make a good vehicle better

Q. How does StabiliTrak work?

A. StabiliTrak has the ability to apply control forces to the vehicle independent of the driver. StabiliTrak uses sensors to continuously compare the path indicated by the steering wheel position to the vehicle's actual path. If a discrepancy is detected, StabiliTrak selectively controls vehicle brakes and engine torque to create a yaw moment that helps restore the vehicle's actual path to the path indicated by the steering wheel position. StabiliTrak has the ability to help correct both understeer (where the vehicle is not turning as much as the steering wheel position indicates) and oversteer (where the vehicle is turning more than the steering wheel position indicates). The illustration at right shows how selective braking at a particular wheel can create a compensating yaw moment to help restore the vehicle's actual path to the path indicated by the steering wheel position.

Q. Will a tire change affect StabiliTrak?

A. Use of tires other than original equipment may affect StabiliTrak performance. StabiliTrak is designed to make the best use of available traction. The performance characteristics of the original equipment tires are part of the overall system effectiveness. When you replace tires check the recommendations in your Owners Manual. On GM vehicles, the original equipment tires have a "TPC" (Tire Performance Criteria) code on the sidewall. Replacing the tires with the same "TPC" code will help assure proper StabiliTrak performance.

SILVERADO 1500 CREW CAB PICKUP WORK TRUCK - 1WT₁₁

UPDATES FOR 2012



FIRST ISSUE IN TECHNICAL MANUAL

2 | SILVERADO 1500 CREW CAB PICKUP WORK TRUCK - 1WT

Note: This vehicle is NOT designed nor intended for use IN HIGH SPEED EMERGENCY VEHICLE OPERATIONS

MODEL AVAILABILITY

CC10543	2-wheel drive 1/2 ton fleetside short box crew cab pickup
CK10543	4-wheel drive 1/2 ton fleetside short box crew cab pickup

STANDARD EQUIPMENT SUMMARY

WARRANTY	3 years / 36,000 miles bumper-to-bumper (whichever comes first, see dealer for details) 5 years / 100,000 miles limited powertrain (whichever comes first, see dealer for details)
----------	---

INTERIOR FEATURES

AIR CONDITIONING	Single-zone manual front climate control
ASSIST HANDLES	Front passenger, rear assist handles in the headliner
AUDIO SYSTEM	AM/FM stereo with seek-and-scan and digital clock with 6-speaker system (XM Radio requires upgrade)
COAT HOOKS	Rear driver and passenger side
CONSOLE	Floor (not available)
CRUISE CONTROL	Electronic with set and resume seed, located on steering wheel.
CUP HOLDERS	Front, and rear
DOOR LOCKS	Power includes rear child security
DRIVER INFORMATION CENTER	Odometer, trip odometer and message center (monitors numerous systems depending on vehicle equipment level including low fuel, turn signal on, transmission temperature and oil change notification) (Driver Information Center controls are operated through the trip button unless UK3 steering wheel mounted audio controls is ordered)
FLOOR COVERING	Black rubberized-vinyl
INSTRUMENTATION	Analog speedometer, odometer, fuel level, engine temperature and tachometer
LIGHTING	Interior with dome and reading lights, illuminates entry feature and backlit instrument panel switches
MIRROR	Inside rearview manual day/night
POWER OUTLETS	2 auxiliary instrument panel-mounted with covers, 12-volt
REMOTE KEYLESS ENTRY	2 transmitters, panic button and content theft alarm (must be ordered and priced separately when SEO (5B5) power windows and mirrors is ordered)
RESTRAINT SYSTEM	Safety belts, driver and front passenger with pretensioners, dual stage driver and passenger frontal air bags ¹ , passenger sensing system and frontal air bag ¹ ON/OFF indicator, rollover sensor, dual head curtain air bags ¹ for first and second row outboard occupants and front seat back mounted thorax-pelvic air bags ¹
SEAT, FRONT	40/20/40 vinyl split-bench, 3-passenger, driver and front passenger manual reclining with outboard head restraints and center fold-down armrest with storage
SEAT, REAR	60/40 folding vinyl bench (folds up), 3-passenger, folding (includes child seat top tether anchor)
STEERING WHEEL	Includes theft deterrent locking feature
STEERING COLUMN	Tilt-wheel, adjustable with brake/transmission shift interlock
VISORS	Driver and front passenger, sliding with clip and illuminated passenger vanity mirror
WARNING TONES	Headlamp on, key-in-ignition, driver and passenger buckle up reminder and turn signal on

1. Head curtain side air bags are designed to help reduce the risk of head and neck injuries to front and rear seat occupants on the near side of certain side-impact collisions. Always use safety belts and the correct child restraints for your child's age and size, even in vehicles equipped with air bags. Children are safer when properly secured in a rear seat. See your vehicle Owner's Manual and child safety seat instructions for more information.

SILVERADO 1500 CREW CAB PICKUP WORK TRUCK - 1WT₁₃

EXTERIOR FEATURES

AIR DAM	Black
BUMPER, FRONT	Black (includes black bumper end caps)
BUMPER, REAR	Chrome, step-style with pad
DAYTIME RUNNING LAMPS	Automatic exterior lamp control
DOOR HANDLES	Black
GLASS	Solar-Ray light-tinted, all windows
GRILLE	Black surround
HEADLAMPS	Dual halogen composite with automatic exterior lamp control and flash-to-pass feature
LAMPS	Dual cargo area lamps
MIRRORS	Outside manual Black, manual-folding
PICKUP BOX	Fleetside short box
RECOVERY HOOKS	Front black (Standard on 4WD available on 2WD)
WINDSHIELD WIPERS	Front intermittent wet-arm with pulse washers

CHASSIS FEATURES

ALTERNATOR	145-amps
BATTERY	Heavy-duty 600 cca, maintenance-free with rundown protection and retained accessory power
BRAKES	4-wheel antilock, front disc, rear drum
ENGINE	Vortec 4.8 V8 SFI FlexFuel (see engine/axle/transmission chart page 4)
EXHAUST	Aluminized stainless-steel muffler and tailpipe
FRAME	Fully-boxed, hydroformed front section
FUEL TANK	26 gallon (98 liter)
REAR AXLE	3.23 ratio with 2WD, 3.42 with 4WD (see engine/axle/transmission chart page 11)
STABILITRAK	Stability control system with proactive roll avoidance, includes electronic trailer sway control and hill start assist
STEERING	Power, rack and pinion
SUSPENSION, FRONT	Independent, coil over shock, includes 35mm twin tube shock absorbers and 36mm front stabilizer bar
SUSPENSION, REAR	2-Stage multi-leaf springs, semi-elliptic
TIRE PRESSURE MONITOR	Tire Pressure Monitor System (does not apply to spare tire)
TIRE, SPARE CARRIER	Outside, winch-type mounted under frame at rear
TIRES	2WD P245/70R17, 4WD P265/70R17 all-season blackwall (includes full-size blackwall spare with spare tire lock utilities same key as ignition/door)
TRANSFER CASE	Floor-mounted shifter (requires 4-wheel drive model)
TRANSMISSION	4-speed automatic, electronically controlled with overdrive and tow/haul mode requires L20 Vortec 4.8L V8 SFI FlexFuel (see engine chart)
WHEELS	17" x 7.5" (43.2 cm x 19.1 cm) steel 6 lug painted, includes painted center caps (spare wheel will not cosmetically match the other 4)

4 | SILVERADO 1500 CREW CAB PICKUP WORK TRUCK - 1WT

POWERTRAIN										
<i>S = Standard A = Available</i>		TRANSMISSION		AXLE				GVWR lbs (kg)		
ENGINE		M30	MYC	GU4 3.08	GU5 3.23	GU6 3.42	GU6 3.73	C3J	C5U	C5W
		4-speed auto. with OD	6-speed auto. Heavy Duty					6700 (3039)	6800 (3084)	7000 (3175)
CC10543	(S) L20 Vortec 4.8L V8 SFI FlexFuel 302 HP @ 5600 rpm/ 305 lb-ft of torque@ 4600 rpm	S	–	–	S	–	A	–	S	–
	(A) LMG Vortec 5.3L V8 SFI FlexFuel 315 HP @ 5200 rpm/ 335 lb-ft of torque@ 4000 rpm	–	S	S	–	A*	–	–	S	–
CK10543	(S) L20 Vortec 4.8L V8 SFI FlexFuel 302 HP @ 5600 rpm/ 305 lb-ft of torque@ 4600 rpm	S	–	–	–	S	–	–	–	S
	(A) LC9 Vortec 5.3L V8 SFI FlexFuel 315 HP @ 5200 rpm/ 335 lb-ft of torque@ 4000 rpm	–	S	S	–	A*	–	–	–	S

** Requires KSL Heavy-duty Cooling Package*

EMISSIONS - MUST BE SPECIFIED	
FE9	FEDERAL EMISSIONS. Use for ordering vehicles that will be registered in all states except California, Connecticut, Maine, Maryland, Massachusetts, New Jersey, New Mexico, New York, Oregon, Pennsylvania, Rhode Island, Vermont and Washington State
YF5	CALIFORNIA EMISSIONS. Use for ordering vehicles that will be registered in California.
NE1	CT/ME/MD/MA/NJ/NM/NY/OR/PA/RI/VT/WA EMISSIONS. Use for ordering vehicles that will be registered in Connecticut, Maine, Maryland, Massachusetts, New Jersey, New Mexico, New York, Oregon, Pennsylvania, Rhode Island, Vermont or Washington State
NB8	Required when option code FE9 "FEDERAL EMISSIONS" is ordered for delivery to a dealer located in California, Connecticut, Massachusetts, Maryland, New Jersey, New Mexico, New York, Oregon, Pennsylvania, Rhode Island and Washington State for a purchaser who will be registering the vehicle outside California, Connecticut, Maine, Maryland, Massachusetts, New Jersey, New Mexico, New York, Oregon, Pennsylvania, Rhode Island, Vermont and Washington State.
NC7	Required when option code YF5 "CALIFORNIA EMISSIONS" or option code NE1 "CT/ME/MD/MA/NJ/NM/NY/OR/PA/RI/VT/WA EMISSIONS" is ordered for delivery to a dealer located in any state except California, Connecticut, Maine, Maryland, Massachusetts, New Jersey, New Mexico, New York, Oregon, Pennsylvania, Rhode Island, Vermont and Washington for a purchaser who will be registering the vehicle in one of these states or sold as permitted below under "EPA Policy on the Sale of California Emission Vehicles"
NB9	Required when option code YF5 is ordered for delivery to a dealer located in Connecticut, Maine, Maryland, Massachusetts, New Jersey, New Mexico, New York, Oregon, Pennsylvania, Rhode Island, Vermont and Washington. Required when option code NE1 is ordered for delivery to a dealer located in California.

SILVERADO 1500 CREW CAB PICKUP WORK TRUCK - 1WT¹⁵

DIMENSIONS (in./mm)		
LOCATION	CC10543 2WD CREW CAB SHORT BOX	CK10543 4X4 CREW CAB SHORT BOX
Wheelbase	143.50/3645	143.50/3645
Overall length	230.20/5847	230.20/5847
Body width	80.00/2032	80.00/2032
Overall height	73.80/1875	73.80/1875
Head room, front	41.20/1046	41.20/1046
Head room, rear	40.50/1029	40.50/1029
Shoulder room, front	65.20/1656	65.20/1656
Shoulder room, rear	65.10/1654	65.10/1654
Hip room, front	62.50/1588	62.50/1588
Hip room, rear	65.40/1661	65.40/1661
Leg room, front	41.30/1049	41.30/1049
Leg room, rear	38.70/983	38.70/983
Cab to axle	32.00/813	32.00/813
Front bumper to axle	39.40/1001	39.40/1001
Rear bumper to axle	47.20/1199	47.20/1199
Inside length, at floor	69.30/1760	69.30/1760
Inside height	21.00/533	21.00/533
Inside width, at floor	62.40/1585	62.40/1585
Tailgate width, top	61.50/1562	61.50/1562
Front bumper to back of cab	148.90/3782	148.90/3782
Ground to top of rear load floor	32.90/836	32.70/831
Inside width, between wheelhousing	50.60/1285	50.60/1285
Ground clearance, front	9.00/229	9.00/229
Ground clearance, rear	12.30/312	12.10/307

Note: Published dimensions indicated are without optional equipment or accessories. Additional accessories or equipment ordered at the customer's request can result in a minor change in these dimensions.

SEATS AND INTERIOR TRIM				
SEAT TYPE		SEAT OPTION	SEAT TRIM	INTERIOR DARK TITANIUM
STANDARD WORK TRUCK	Front: 40/20/40 split-bench with fold-down armrest Rear: 60/40 folding bench	AE7	Vinyl [†]	88V
OPTIONAL WORK TRUCK	Front: 40/20/40 split-bench with fold-down armrest and manual driver lumbar Rear: 60/40 folding bench	AE7	Cloth ^{††}	88B

[†]- Vinyl seats require BG9 Black rubberized-vinyl floor covering
^{††}- Seats are Ebony seating surfaces and Ebony bolsters

AVAILABLE EXTERIOR COLORS



37U
Imperial Blue*
Metallic



GAN
Silver Ice*
Metallic



41U
Black



46U
Blue Granite
Metallic













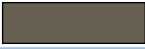















50U
Summit White

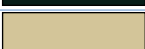

74U
Victory Red

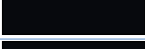
Actual colors may vary * Not available until 4th quarter 2011

SEO PAINT AVAILABLE

WA#	COLOR DESCRIPTION		CODE
228A	Light Autumnwood Metallic		
253A	Wheatland Yellow		9W3
334D	Dark Toreador Red		
382E	Pewter		
454N	Blue		
769H	Blue		
770H	Orange		
815K	Arrival Blue		
926L	Silver Burch Metallic		
5248	Yellow		
5405	Blue Metallic		
5445	Yellow		
5456	Yellow		
5663	Blue		
5758	Green		
7154	Blue		
7159	Blue Metallic		
7840	Gray Metallic		
7941	Green		
9015	Woodland Green		9V5
9403	Doeskin Tan		9V9
9414	Yellow		
9417	Tangier Orange		9W4
9419	Orange		
9539	Green Metallic		
9792	Indigo Blue		

ACTUAL COLOR MAY VARY

Note: • Door handles and mirrors will be Flat Black. Deletes standard/package body side moldings.

• All normally body-colored non-sheet metal parts, will be Flat Black

• SEO paint orders that contain less than five vehicles will be delayed until five unit minimum is received for batch production

SILVERADO 1500 CREW CAB PICKUP WORK TRUCK - 1WT₁₇

AVAILABLE OPTIONS

BVQ	ASSIST STEPS - Chrome tubular 6" oval
US8	AUDIO SYSTEM - AM/FM stereo with MP3 compatible CD player, seek-and-scan, digital clock, auto-tone control, Radio Data System (RDS), speed-compensated volume and theftlock, required with U2K XM Radio
VML	BED DIVIDER, SLIDING - Requires VMK Cargo Management System Rails, not available with VMM Overhead rack/bed divider
VZX	BED LINER - Included with PDC On The Job Package (not available with VBN Bed rug, bed cover or VBR Rubber bed mat)
VBR	BED MAT, RUBBER - Not available with VBN Bed rug, bed cover
RW1	BED RAIL PROTECTORS - Included with PDC, On The Job Package, not available with VQG Protection Package
VBN	BED RUG - Bed cover, foam backed gray colored carpet like material that covers the entire bed, not available with VBR Rubber bed mat
UPF	BLUETOOTH FOR PHONE ¹⁰ - Personal cell phone connectivity to vehicle audio system; includes K34 cruise control, UK3 steering wheel-mounted audio controls and NP5 leather-wrapped steering wheel, requires UE1 OnStar ⁸ and US8 AM/FM stereo with MP3 compatible CD player, not available with UE0 OnStar delete or UM7 AM/FM stereo
VMK	CARGO MANAGEMENT SYSTEM RAILS
KNP	COOLING, AUXILIARY EXTERNAL TRANSMISSION OIL COOLER - Heavy-duty air-to-oil included and only available with Z82 Trailing Package or K5L HD Cooling Package
KC4	COOLING, ETERNAL OIL COOLER - Included and only available with K5L Heavy-duty Cooling Package
K5L	COOLING PACKAGE, HEAVY DUTY - Includes KC4 external engine oil cooler, KNP auxiliary external transmission oil cooler, electric fan and heavy-duty radiator (requires MYC 6-speed automatic transmission)
C49	DEFOGGER - Rear-window electric, included with PCW Convenience Package. Not available with A48 power sliding rear window
G80	DIFFERENTIAL, REAR - Heavy-duty automatic locking rear
B30	FLOOR COVERING, COLOR-KEYED CARPETING - Rubberized-vinyl floor mats front and rear included (requires 88B Dark Titanium cloth seat trim)
VAV	FLOOR MATS, ALL-WEATHER - Ebony deep ribbed rubber front and rear; requires B30 color-keyed carpeting, not available with BG9 Black rubberized-vinyl floor covering
AJ1	GLASS, SOLAR-RAY DEEP-TINTED - All windows except light-tinted glass on windshield and driver and front passenger side glass with C49 rear window defogger, includes light-tinted rear window
KO5	HEATER - Engine block
V76	HOOKS, RECOVERY - Black on front (standard on 4WD)
8X1	LABEL, FASTEN SAFETY BELTS - "Fasten safety belts" reminder label on side door window glass
VK3	LICENSE PLATE BRACKET, FRONT - (Will be forced on orders with "ship to" states that require a front license plate)
VBR	MAT - Rubber bed mat
6P3	MIRRORS, CAMPER, POWER-ADJUSTABLE GLASS, MANUAL EXTENDABLE, HEATED - Alternative mirrors replacing mirrors that are standard with SEO 5B5 power windows, locks and mirrors on a base decor truck; provides RPO DPN outside heated power-adjustable manual folding vertical camper mirrors consisting of 50 square inch flat mirror surface positioned over a 20 square inch convex mirror surface with a common head; includes turn signals in mirror glass; (requires SEO 5B5 power windows locks and mirrors; this option must be ordered and priced in addition to SEO 5B5)
DF2	MIRRORS, OUTSIDE HIGH-VISIBILITY VERTICAL CAMPER-STYLE, BLACK - Manual folding and extension and lower convex spotter glass
PDC	ON THE JOB PACKAGE - Includes the following dealer installed accessories: VZX Skid-resistant bed liner, RW1 Bedrail protectors, LPO and SCO Bed mounted tie-down hooks. Not available with VQG, VQT, VPB or SD7
UE1	ONSTAR ⁸ - 6 months of Directions and Connections plan, includes Automatic Crash Response, Emergency Services, Crisis Assist, Stolen Vehicle Assistance including Stolen Vehicle Slowdown and Remote Ignition Block, Remote Door Unlock (requires power locks), Turn-by-Turn Navigation with Destination Download (requires navigation radio) and OnStar eNav (where available), OnStar Vehicle Diagnostics, Roadside Assistance, Remote Horn and Lights, and available Hands Free Calling. 1 - Retail orders require (AU3) power door locks and (AU0) Remote Keyless Entry. Visit onstar.com for details and system limitations.

8. Visit OnStar.com for coverage map, system limitations and details.

10. Go to gm.com/bluetooth to find out which Bluetooth phones are compatible with the vehicle.

AVAILABLE OPTIONS (CONTINUED)

R8G	ONSTAR⁸ - 1 Additional Year of Safe and Sound Service. Provides 1 year of Safe and Sound service following the first year of OnStar service included in the price of the vehicle. Fleet may also order RFA OnStar Business Vehicle Manager Service; requires UE1 OnStar 1-year Safe and Sound plan. Requires one of the following Fleet or Government order types: FLS, FNR, FRC, FBC, FGO or FEF. Not available with R8P, R8W, R8Y, R8Z, RFG or RFH.
R8W	ONSTAR⁸ - 1-Year Directions and Connections Service. Provides an upgrade from Safe and Sound service included in the price of the vehicle in the first year. Fleet may also order RFA OnStar Business Vehicle Manager Service; requires UE1 OnStar 1-year Safe and Sound plan. Requires one of the following Fleet or Government order types: FLS, FNR, FRC, FBC, FGO or FEF. Not available with R8G, R8P, R8Y, R8Z, RFG or RFH.
R8P	ONSTAR⁸ - 2 Additional Years of Safe and Sound Service. Provides 2 additional years of Safe and Sound service following the first year of OnStar service included in the price of the vehicle. Fleet may also order RFA OnStar Business Vehicle Manager Service; requires UE1 OnStar 1-year Safe and Sound plan. Requires one of the following Fleet or Government order types: FLS, FNR, FRC, FBC, FGO or FEF. Not available with R8G, R8W, R8Y, R8Z, RFG or RFH.
R8Y	ONSTAR⁸ - 2-Years Directions and Connections Service. Provides cumulative 2 Years of Directions and Connections service. In the first year, this is an upgrade from Safe and Sound service included in the price of the vehicle. Fleet may also order RFA OnStar Business Vehicle Manager Service; requires UE1 OnStar 1-year Safe and Sound plan. Requires one of the following Fleet or Government order types: FLS, FNR, FRC, FBC, FGO or FEF. Not available with R8G, R8P, R8W, R8Z, RFG or RFH.
R8Z	ONSTAR⁸ - 3-Years Directions and Connections Service Provides cumulative 3 Years of Directions and Connections service. In the first year, this is an upgrade from Safe and Sound service included in the price of the vehicle. Fleet may also order RFA 3-Year OnStar Business Vehicle Manager Service; requires UE1 OnStar 1-year Safe and Sound plan. Requires one of the following Fleet or Government order types: FLS, FNR, FRC, FBC, FGO or FEF. Not available with R8G, R8P, R8W, R8Y, RFG or RFH.
RFG	ONSTAR⁸ - 3 Additional Years Safe and Sound Service. Provides 3 additional Years of Safe and Sound service following the first year of OnStar service included in the price of the vehicle. Fleet may also order RFA OnStar Business Vehicle Manager Service; requires UE1 OnStar 1-year Safe and Sound plan. Requires one of the following Fleet or Government order types: FLS, FNR, FRC, FBC, FGO or FEF. Not available with R8G, R8P, R8W, R8Y, R8Z or RFH.
RFA	ONSTAR⁸ - Business Vehicle Manager Service. Provides OnStar Business Vehicle Manager Service equal to the length of OnStar service, requires one of the following Fleet or Government order types: FLS, FNR, FRC, FBC, FGO or FEF.
VZV	OVERHEAD UTILITY RACK - Operates and slides on the cargo management system, requires VMK Cargo Management System Rails. Not available with VQT, VBP and VPB
VMM	OVERHEAD RACK/BED DIVIDER - Operates and slides on the cargo management system. Rack flips down to function as a bed divider requires VMK Cargo Management System Rails. Not available with VQT, VBP and VPB
VQG	PROTECTION PACKAGE - Includes rear wheelhouse liner, molded splash guards and bed rail protector
TGK	PAINT, SPECIAL, SOLID ONE COLOR - All normally body colored non-sheet metal parts will be flat Black. Flat black door handles and mirrors. Requires 01U special paint with any special paint selection. May require an extend lead time. Requires CK10543 4WD model LC9 Vortec 5.3L variable valve timing V8 SFI FlexFuel engine and MYC 6-speed automatic transmission.
9V9	PAINTS, SOLID, DOESKIN TAN - All normally body colored non-sheet metal parts will be flat black. Door handles and mirrors will be flat black. Requires TGK Special Paint. Not available on model CC10543. Requires LC9 Vortec 5.3L variable valve timing V8 SFI Flexfuel engine and MYC 6-speed automatic transmission.
9W4	PAINTS, SOLID, TANGIER ORANGE - All normally body colored non-sheet metal parts will be flat black. Door handles and mirrors will be flat black. Requires TGK Special Paint. Not available on model CC10543. Requires LC9 Vortec 5.3L variable valve timing V8 SFI Flexfuel engine and MYC 6-speed automatic transmission.
9W3	PAINTS, SOLID, WHEATLAND YELLOW - All normally body colored non-sheet metal parts will be flat black included and flat black door handles and mirrors. Requires TGK Special Paint. Not available on model CC10543. Requires LC9 Vortec 5.3L variable valve timing V8 SFI Flexfuel engine and MYC 6-speed automatic transmission.
9V5	PAINTS, SOLID, WOODLAND GREEN - All normally body colored non-sheet metal parts will be flat black. Door handles and mirrors will be flat black. Requires TGK Special Paint. Not available on model CC10543. Requires LC9 Vortec 5.3L variable valve timing V8 SFI Flexfuel engine and MYC 6-speed automatic transmission.
9L4	POWER SUPPLY, 12-VOLT DIRECT POWER SUPPLY FROM THE BATTERY - With two (2) separate 30-amp fused circuits; each circuit has a 30-amp mini-fuse for both positive and ground to protect electrical accessories; main supply lead has a 60-amp maxi-fuse; all fuses are serviceable; provides either direct battery power or operation through the ignition system; hook-up wire is located at the front of the floor console; operational amperage is 21-amps each circuit, 42-amps total; hook-up and operational instructions are provided
5B5	POWER WINDOWS AND MIRRORS, WITH UPLEVEL DOOR PANELS ON A BASE TRIM LEVEL VEHICLE - Provides power driver and passenger front side windows with uplevel door panels on a base level vehicle; includes RPO DL8 outside heated power-adjustable manual folding mirrors and RPO UQ3 speaker system audio system feature; includes rear door power windows and; power mirrors can be upgraded to SEO 6P3 camper, power-adjustable glass, manual extendable, heated mirrors; (RPO AU0 remote keyless entry becomes optional on all models and must be ordered and priced if desired)

5. Gross Vehicle Weight Rating (GVWR). When properly equipped, includes vehicle, passengers, cargo and equipment.

8. Visit OnStar.com for coverage map, system limitations and details.

SILVERADO 1500 CREW CAB PICKUP WORK TRUCK - 1WT₁₉

AVAILABLE OPTIONS (CONTINUED)

AU0	REMOTE KEYLESS ENTRY - With 2 transmitters, panic button and content theft alarm, requires SE0 5B5 power windows, locks and mirrors
88B	SEAT TRIM - Dark Titanium cloth
AM1	SEAT ADJUSTER, MANUAL LUMBAR CONTROL ON THE DRIVERSIDE - (Included and only available with 88B Dark Titanium cloth seat trim)
NZZ	SKID PLATE PACKAGE, FRAME-MOUNTED SHIELDS - Includes front underbody shield starting behind front bumper and running to first cross member, protecting front underbody, oil pan, differential case and transfer case (requires 4WD model)
SAF	SPARE TIRE LOCK - Keyed cylinder lock that utilizes same key as ignition and door (not available with ZW9 pickup box delete or VF7 rear bumper delete)
NP5	STEERING WHEEL - Leather-wrapped with theft-deterrent locking feature, only available with UPF Bluetooth for phone
UK3	STEERING WHEEL CONTROLS - Mounted audio controls included and only available with UPF Bluetooth for phone
VXJ	STEPS ASSIST, CHROMED TUBULAR - 3" round (dealer installed); not available with VXH 6" oval tubular assist steps or LML/LGH Duramax 6.6L turbo diesel V8 engine
Z85	SUSPENSION PACKAGE - Handling/Trailer, heavy-duty, includes 46 mm piston monotube shocks and 36mm front stabilizer bar, included and only available with Z82 Trailing package
A60	TAILGATE - Locking
PPA	TAILGATE - EZ-lift included and only available with (A60) locking tailgate.
QJP	TIRES - P265/70R17 on-/off-road, blackwall, includes an all-season blackwall spare (requires 4WD model)
QXR	TIRES - LT245/70R17 all-terrain, blackwall, 5-ply load range C, (includes all-terrain spare)
VQT	TONNEAU COVER - Hard tri-folding with vinyl cover requires Bed rail protectors, not available with PDC On The Job Package, VQG Protection Package, VPB Soft tonneau cover or VBP Hard tri-folding tonneau cover
VBP	TONNEAU COVER - Hard tri-folding with premium cloth cover requires Bed rail protectors, not available with PDC On The Job Package, VQG Protection Package, VPB Soft tonneau cover or VQT Hard tri-folding tonneau cover
VPB	TONNEAU COVER - Soft with integrated support bows that roll up with the cover and can be stowed in behind the cab not available with PDC On The Job Package, VBP Hard tri-folding tonneau cover or VQT Hard tri-folding tonneau cover
SD7	TONNEAU COVER - Hard shell requires exterior color 37U Imperial Blue Metallic, 41U Black, 46U Blue Granite Metallic, 50U Summit White or 74U Victory Red. Not available with C*109*3 models
VZZ	TOOL BOX, STATIONARY - Single lid, includes diamond patterned steel side storage box has codeable lock that works with ignition key
JL1	TRAILER BRAKE CONTROLLER - Requires Z82 heavy-duty trailing package
Z82	TRAILERING PACKAGE FOR M30 4-SPEED TRANSMISSION - heavy-duty includes trailering hitch platform and 2-inch receiver, 7-wire harness (harness includes wires for: park lamps, backup lamps, right turn, left turn, electric brake lead, battery and ground) with independent fused trailering circuits mated to a 7-way sealed connector, wiring harness for after-market trailer brake controller (located in the instrument panel harness) and KNP external transmission oil cooler. requires M30 4-speed automatic transmission. Not available Z83 Solid Smooth Ride Suspension Package. Requires M30 4-speed automatic transmission. Includes Z85 Handling/Trailer Suspension Package. Requires M30 4-speed automatic transmission.
Z82	TRAILERING PACKAGE FOR MYC 6-SPEED TRANSMISSION - heavy-duty includes trailering hitch platform and 2-inch receiver, 7-wire harness (harness includes wires for: park lamps, backup lamps, right turn, left turn, electric brake lead, battery and ground) with independent fused trailering circuits mated to a 7-way sealed connector, wiring harness for after-market trailer brake controller (located in the instrument panel harness), K5L heavy-duty cooling package, KC4 external engine oil cooler and KNP external transmission oil cooler 1 - Requires MYC 6-speed automatic transmission. Includes Z85 Handling/Trailer Suspension Package. Requires MYC 6-speed automatic transmission.
MYC	TRANSMISSION - 6-speed automatic, electronically controlled with overdrive and tow/haul mode. Included and only available with LMG or LC9 Vortec 5.3L engine
VBJ	UNDERSEAT STORAGE - Composite storage bin under the rear seat, not available on C*10953 or C*10*03 models

AVAILABLE OPTIONS (CONTINUED)

- 5B5 **WINDOWS AND MIRRORS, POWER** - Deletes Remote Keyless Entry Provides power driver and passenger front side windows with uplevel door panels on a base trim level vehicle. Includes DL8 outside heated power-adjustable manual folding mirrors, AU3 power door locks and UQ3 speaker system. Includes rear door power windows. Power mirrors can be upgraded to 6P3 camper, power-adjustable glass, manual extendable, heated mirrors. (Remote Keyless Entry becomes optional on all models and AU0 Remote Keyless Entry must be ordered and priced if desired.)
- U2K **XM RADIO**⁹ - Includes three trial months of service; requires US8 AM/FM stereo with MP3 compatible CD player and UE1 OnStar⁸. XM service available only in the 48 contiguous United States and the District of Columbia. XM Radio subscription required and sold separately after trial period. Fees, taxes, and a one-time re-activation fee, may apply. Subscriptions governed by XM Customer Agreement available at xmradio.com. All fees and programming subject to change. Family programming packages are available
-

8. Visit OnStar.com for coverage map, system limitations and details.

9. XM Radio requires a subscription, sold separately by XM after the trial period. Not available in Canada, Alaska or Hawaii. For more information, visit gm.xmradio.com.

CREW CAB SPECIFICATIONS

	CC10543 2WD CREW CAB SHORT BOX	CK10543 4X4 CREW CAB SHORT BOX
SPECIFICATIONS		
Front shock absorber diameter, in. (mm)	1.81/46	1.81/46
Front stabilizer bar diameter, in. (mm)	1.42/36	1.42/36
Rear shock absorber diameter, in. (mm)	1.38/35	1.38/35
Turning diameter, curb-to-curb, ft. (m)	47.2/14.4	47.2/14.4
CAPACITIES		
Front axle, lbs. (kg)	3650/1656	3950/1792
Front spring capacity, lbs. (kg)	3650/1656	3950/1792
Rear axle, lbs. (kg)	3950/1792	4000/1814
Rear spring capacity, lbs. (kg)	3950/1792	3950/1792
Curb weight, lbs. (kg)	5095/2311	5329/2417
Cargo volume ³ , cargo box, cu. ft. (liters)	53.2/1506.6	53.2/1506.6
Payload ⁶ , lbs. (kg)	1705/773	1671/758
Gross Vehicle Weight Rating ⁵ (GVWR), lbs. (kg)	6800/3084	7000/3175
Front Gross Axle Weight Rating (FGAWR), L96, lbs. (kg)	3650/1656	3950/1792
Rear Gross Axle Weight Rating, lbs. (kg)	3750/1701	4300/1950
Fuel capacity, approximate, gallon (liters)	26/98	26/98
Seating capacity	3/3	3/3

AUTOMATIC TRANSMISSION - WITH BALL HITCH

MODEL	(L20) VORTEC 4.8L V8 SFI FLEXFUEL		(LGM/LC9) VORTEC 5.3L V8 SFI FLEXFUEL	
	AXLE RATIO	MAXIMUM TRAILERING	AXLE RATIO	MAXIMUM TRAILERING
CC10543	3.23	4700/2132	3.08	6800/3084
			3.42	9600/4355
CK10543	3.42	5500/2495	3.08	6700/3039

Silverado 1500 models are limited to 5000 lb. trailer rating unless equipped with (Z85) Handling/Trailer Suspension Package, (Z60) High-Performance Suspension Package or (Z71) Off-Road Suspension Package.

Addition of trailer tongue weight cannot cause vehicle weights to exceed Rear Gross Axle Weight Rating (RGVWR) of Gross Vehicle Weight Rating (GVWR).

(Z82) Trailing Equipment, heavy-duty includes trailer hitch platform, trailer electrical connector and suspension upgrade if necessary.

GCWR - ENGINE/REAR AXLE RATIO COMBINATION WITH AUTO TRANSMISSION

ENGINE	(GCWR) GROSS COMBINATION WEIGHT RATINGS lbs. (kg)				
	10,000 (4,536)	11,000 (4,990)	11,500/5,216	12,000/5,443	15,000/6,804
(L20) Vortec 4.8L V8 SFI FlexFuel	3.23	3.42		3.73	
(LGM/LC9) Vortec 5.3L V8 SFI FlexFuel		3.08	3.42*		3.42**

* - Requires (MYC) 6-speed automatic transmission. Not available with (KSL) Heavy-duty cooling package.

** - Requires (MYC) 6-speed automatic transmission and (KSL) Heavy-duty cooling package.

Can specialty vehicle equipment (e.g. radar devices, video cameras, computers, meters, radio trees, shotguns, etc.) still be mounted in cars with passenger side air bags?

Yes, but care must be taken to mount the equipment outside of the deployment zone. Air bags inflate with great force and will interact with any object in the deployment zone. Therefore, to reduce the risk of injury to vehicle occupants, GM recommends that the air deployment zone be kept free of any equipment. If a piece of equipment were to become dislodged it could strike an occupant in the vehicle and result in injury. The likelihood of an object becoming dislodged is influenced by many factors, including the proximity of the object to the inflatable restraint, the size and shape of the object, and the means by which the object is secured to the vehicle. In addition to these factors, the trajectory and velocity of a dislodged object can be influenced by the type and severity of vehicle crash.

Objects that are in the deployment zone, but do not become dislodged by an inflating air bag can still affect the performance of the air bag. For example, such objects could tear the fabric or affect the shape of the air bag, thus reducing the ability of the bag to provide restraint.

Is it possible to shield equipment that is installed in the passenger side frontal air bag deployment zone in a manner that will allow full and safe air bag deployment?

Due to the complexity of influencing variables, GM is unable to evaluate the potential for shielding expected equipment configurations in all accident scenarios in order to assure that the air bag performance would be unaffected. While shielding may protect certain equipment from being damaged or dislodged, it may also negatively affect the inflation characteristics of the air bag. The air bag's shape, inflation angle, fold pattern, and inflation rate and pressure are developed to maximize the protection capability of the inflatable restraint system. Therefore, GM cannot recommend the placement of any equipment in the deployment zone, even if it is shielded to protect it from damage.

Front air bag systems and instrument panel mounted equipment.

Passenger air bags in GM vehicles deploy in different ways depending upon the type of vehicle and the particular instrument panel design.

In some vehicles, the passenger air bag deploys through a discrete door located on the top surface of the instrument panel (top-mount air bag systems). In other vehicles, such as the Chevrolet Tahoe, the passenger air bag deploys through a discrete door mounted on the vertical rearward surface of the instrument panel, above the glove box door (mid-mount air bag system). With these types of top-mount and mid-mount passenger air bag systems, the top pad of the instrument panel remains in place during deployment.

Some GM passenger air bag systems, like the system in the Chevrolet Impala, deploy from beneath the instrument panel top pad. These are considered 3/4-mount air bag systems with a "deployable top pad." The entire instrument panel top pad is the "deployment door" from under which the inflating air bag emerges. When an air bag deployment is commanded, the forces from the inflating passenger air bag push up on the instrument panel top pad, releasing special fasteners across the rearward edge of the top pad. This allows the top pad to rotate upward so that the passenger air bag may emerge. The top pad rotates upward to open widest at the right hand side, and is usually forced upward into contact with the windshield on the right hand side of the vehicle during a deployment.

Head curtain side air bags are designed to help reduce the risk of head and neck injuries to front and rear seat occupants on the near side of certain side-impact collisions. Always use safety belts and the correct child restraints for your child's age and size, even in vehicles equipped with air bags. Children are safer when properly secured in a rear seat. See your vehicle Owner's Manual and child safety seat instructions for more information.

Instrument panel top mounted special equipment, such as a radar antenna and control unit or video camera must be positioned to the left of the vehicle center line. This equipment must be mounted as low as possible and securely fastened to the top pad to avoid being dislodged in the event of a crash and possible air bag deployment. In the process of securely fastening special equipment to the top, DO NOT fasten down the top pad itself to any other vehicle component such as the cluster trim plate. As described above, the top pad rotates upward during a deployment. In order to enable the proper deployment of the passenger air bag, specialty equipment installation MUST NOT PREVENT the top pad from rotating upward during deployment. Location and attachment of special equipment should minimize added resistance or interference to upward rotation of the top pad during deployment.

Optional side air bags for crashes to the vehicle sides.

The air bag system in your police vehicle may include optional side air bags for front and rear occupants. Most front-to-rear side air bags are designed to deploy downward from the interior roof sides to the bottom of the door windows.

Can Specialty Vehicle Security Barriers be mounted within the side air bag deployment zones?

No. The side air bags inflate extremely fast because of the nature of side crashes to the vehicle. Mounting a security barrier behind the front seats with the ends placed within the side air bag deployment zones will result in unintended interaction between the barrier and the inflating side air bags. To reduce the risk of injury to the vehicle occupants, GM recommends that the side air bag zones be kept free of any customer installed equipment.

Customer furnished equipment installed to the vehicle roof.

Your police vehicle is designed with an interior roof cover system which includes internal components for the interior lamps and wiring. The roof system may also include optional side air bag components. Inflation devices may be mounted on the vehicle roof side behind the rear doors as well as air bag tethers retained to the windshield pillars. Care must be taken to avoid damage to these components or interference with their operation when installing roof mounted equipment such as emergency lamps and communication antennas.

Recommended GM service procedures must be followed to remove and re-install the instrument panel top pad to ensure that the top pad will release properly in the event of a passenger air bag deployment.

On the right half of the top pad closest to the passenger air bag module, GM recommends that no equipment be mounted. When mounting equipment on the driver side of the top pad, GM recommends that the total mass of the top pad mounted special equipment not exceed 8 pounds (3.6 kilograms), since the top pad tends to rotate about the left end.

Fasteners used to secure special equipment to the instrument panel top pad, the windshield glass, or to the windshield upper frame (header), should be selected to ensure that these devices will remain attached during a vehicle crash and possible air bag deployment.

Can the installation of push bumpers on the front end of the vehicle affect the deployment of the air bag?

General Motors is not aware of adverse effects during crash events from the many push bumpers that have been installed on GM police vehicles. Because there are many styles of push bumpers available with varying crash characteristics, installation of push bumpers may or may not affect deployment timing of the air bags. Push bumpers should be mounted to avoid modifying the vehicle structure and interfering with the front air bag sensors mounted on the upper radiator support cross member.

Two front impact sensors are installed in General Motors vehicles. Do not relocate or disconnect the front sensors. The location and orientation of the front sensors are critical for correct operation of the air bag system. Avoid mounting components on or near the sensors. Push bumper styles with vertical pushing members that are in fore-aft alignment with the front air bag sensors are not recommended.

How long will the air bag remain inflated?

It takes approximately 1/20th of a second to fully inflate the frontal air bags. This is faster than the blink of an eye. The air bags begin to deflate immediately, helping to stop the occupants more gradually.

Can the air bag system be re-used?

No. The air bags are designed to inflate only once. After inflation some new parts will be required. These will include the air bag module and possibly other parts. (A competent service technician with access to the vehicle's service manual and the required tools should replace the required components after a deployment crash.)

I've heard that the dusts that are released into the passenger compartment from the air bag are harmful. Is this true?

For most people, the only effect the dusts will produce is some irritation of the throat and eyes, and that is only if the occupant remains in the vehicle for many minutes after the air bag deployment with no ventilation and windows closed. However, some people with asthma may develop an asthmatic attack from inhaling the dusts. If this happens, they should first treat themselves the same way their doctor has advised them to treat any other asthma attack, and then immediately seek medical treatment.

When should an air bag inflate?

The driver's and right-front passenger's frontal air bags are designed to inflate in moderate to severe frontal or near-frontal crashes. But they are designed to inflate only if the impact speed is above the system's designed "threshold level."

In addition, if your vehicle has "dual stage" frontal air bags, these air bags tailor the amount of restraint according to crash severity. For moderate frontal impacts, the air bags inflate at a level less than full deployment. For more severe frontal impacts, "dual stage" frontal air bags deploy at full levels.

If the front of your vehicle goes straight into a wall that doesn't move or deform, the threshold level of the reduced deployment is about 12 to 16 mph (19 to 15 km/h), and the threshold level for a full deployment is about 18 to 24 mph (29 to 28.5 km/h). The threshold level can vary, however, with specific vehicle design, so that it can be somewhat above or below this range.

If your vehicle strikes something that will move or deform such as a parked car, the threshold level will be higher. The driver's and right-front passenger's frontal air bags are not designed to inflate in rollover, side impacts, or rear impacts, because inflation would not help the occupant.

Head curtain side air bags are designed to help reduce the risk of head and neck injuries to front and rear seat occupants on the near side of certain side-impact collisions. Always use safety belts and the correct child restraints for your child's age and size, even in vehicles equipped with air bags. Children are safer when properly secured in a rear seat. See your vehicle Owner's Manual and child safety seat instructions for more information.

Seat mounted side impact air bags are designed to inflate in moderate to severe side crashes. The side impact air bags will inflate if the crash severity is above the designed "threshold level." The threshold level can vary with specific vehicles design. The side impact air bags are not designed to inflate on frontal or near-frontal impacts or rear impacts, because inflation would not help the occupant.

Roof rail mounted head-curtain air bags are designed to inflate in moderate to severe side crashes. In addition, certain vehicles have head-curtain air bags which are also designed to inflate in situations where an impending rollover condition is identified by the vehicle's rollover sensing system and/or frontal or near-frontal impacts if the crash severity is above the designed "threshold level".

Safety belt pretensioners at the driver and front passenger seat positions are designed to deploy in frontal, near-frontal, side, and rear crashes that exceed the "threshold level" of crash severity to help reduce slack in the safety belt. Safety belt pretensioners will also deploy in impending rollover situations.

I've heard that a deployed air bag produces what appears to be smoke. Is the air bag hot?

After the bag has deployed in a crash, the air bag itself will not be hot to touch. Some components within the air bag module will be hot for a short time. A small amount of smoke coming from a deployed air bag module is normal and should not be cause for concern.

Also, when the nitrogen gas is vented out of the air bag, small particles from inside the bag are also vented into passenger compartment. These airborne particles look like smoke and some particles are deposited as residue on and around the air bag.

If my vehicle has air bags, why should I have to wear my safety belt?

Air bags are in many vehicles today and will be in most of them in the future. But they are supplemental systems only; so they work with safety belts - not instead of them. Every air bag system ever offered for sale has required the use of safety belts. Even if you're in a vehicle that has air bags, you still have to buckle up to get the most protection. That's true not only in frontal collisions but especially in side and other collisions.

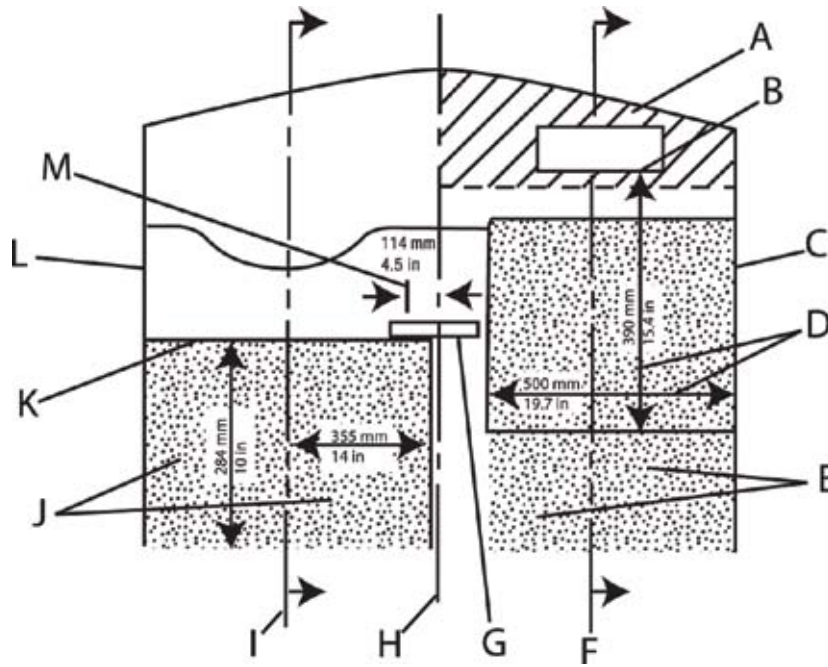

TOP VIEW OF INSTRUMENT PANEL AND APPROXIMATE DEPLOYMENT AREA OF THE AIR BAG ZONE

- A. Passenger side instrument panel top surface zone
- B. Passenger side air bag module trim panel – rear edge
- C. Passenger side door
- D. Approximate dimensions of inflated air bag
- E. Passenger side air bag deployment zone
- F. Passenger centerline
- G. Inside rearview mirror
- H. Vehicle centerline
- I. Driver centerline
- J. Driver side air bag deployment zone
- K. Front of steering wheel
- L. Driver side door
- M. Shift selector arc

Head curtain side air bags are designed to help reduce the risk of head and neck injuries to front and rear seat occupants on the near side of certain side-impact collisions. Always use safety belts and the correct child restraints for your child's age and size, even in vehicles equipped with air bags. Children are safer when properly secured in a rear seat. See your vehicle Owner's Manual and child safety seat instructions for more information.

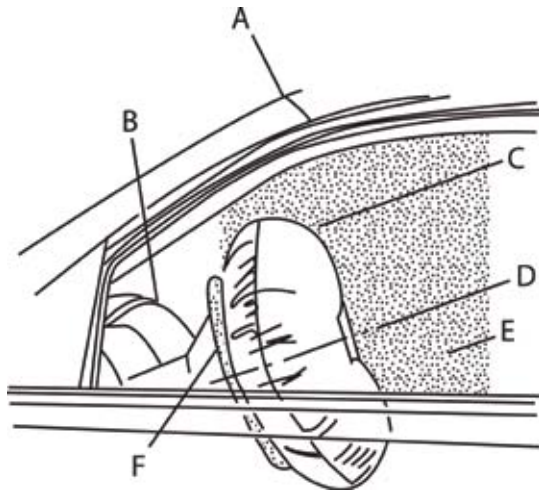

SIDE VIEW OF DRIVER SIDE AIR BAG DEPLOYMENT ZONE

- A. Top edge of windshield
- B. Top of instrument panel
- C. Inflated air bag – steering wheel
- D. Centerline of steering column at mid-tilt
- E. Driver air bag deployment zone
- F. Front of steering wheel

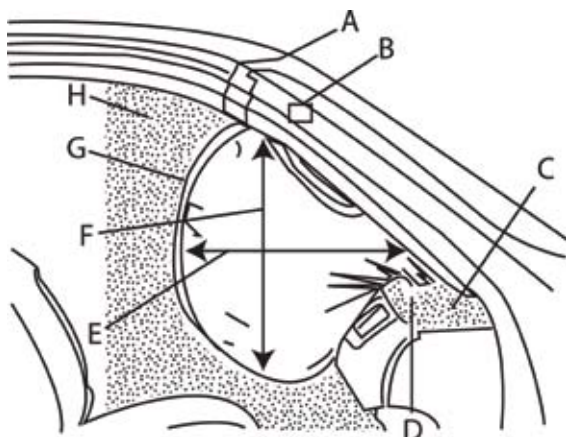

SIDE VIEW OF PASSENGER SIDE AIR BAG DEPLOYMENT ZONE

- A. Top edge of windshield
- B. Inside rearview mirror
- C. Instrument panel top surface zone
- D. Passenger side air bag module trim panel – rear edge
- E. Inflated air bag – horizontal dimension approximate 15.4 in (390 mm)
- F. Inflated air bag – vertical dimension approximate 9.3 in (490 mm)
- G. Inflated air bag – instrument panel
- H. Passenger air bag deployment zone

Head curtain side air bags are designed to help reduce the risk of head and neck injuries to front and rear seat occupants on the near side of certain side-impact collisions. Always use safety belts and the correct child restraints for your child's age and size, even in vehicles equipped with air bags. Children are safer when properly secured in a rear seat. See your vehicle Owner's Manual and child safety seat instructions for more information.

HEAD CURTAIN AND FRONT SEAT-MOUNTED SIDE IMPACT AIR BAG DEPLOYMENT ZONES
PASSENGER SIDE SHOWN, DRIVER SIDE SIMILAR

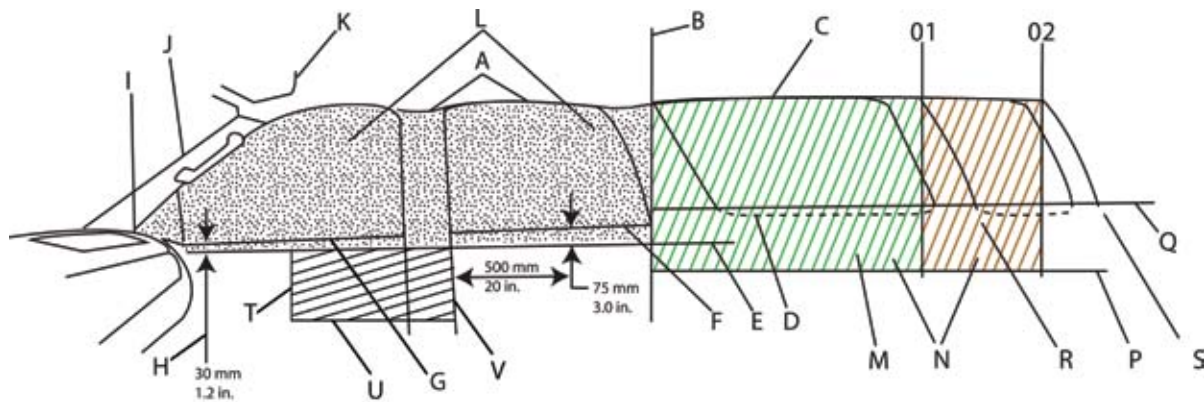

Tahoe/Suburban/Silverado Crew Cab Seat Rows 1 and 2

- A. Top of deployment zone – along head curtain at edge of headliner
- B. Back of deployment zone – at rear top corner of rear door pad
- C. Rear quarter window
- D. Bottom outside edge of rear quarter window
- E. Bottom of air bag deployment zone – parallel to outside bottom edge of rear quarter glass
- F. Top edge of rear door pad
- G. Top edge of front door pad
- H. Dimension at mirror patch from top edge of front door pad
- I. Front of deployment zone at front upper corner of front door pad
- J. Windshield pillar trim with grab handle
- K. Visor
- L. Deployment zone - Tahoe seat rows 1 and 2

Tahoe/Suburban 3rd Row Seats

- M. Deployment zone - Tahoe 3rd seat
- N. Deployment zone - Suburban 3rd seat
- O. Rear zones at back corner of headliner: 1 Tahoe, 2 Suburban
- P. Bottom of 3rd seat zone at rear side trim cup holders
- Q. Top edge of rear quarter trim at window
- R. Rear of Tahoe
- S. Rear of Suburban

Tahoe/Suburban/Silverado Crew Cab Seat Air bag

- T. Center of door trim pull handle
- U. Top of surface of outboard front seat cushion
- V. Back edge of center pillar trim

Note: The head curtain air bag inflators are mounted in a different orientation on the Silverado Crew Cab pickup truck roof structure from those in the Tahoe/Suburban.

HEAD CURTAIN AND FRONT SEAT-MOUNTED SIDE IMPACT AIR BAG DEPLOYMENT ZONES
VIEW FROM REAR CARGO AREA

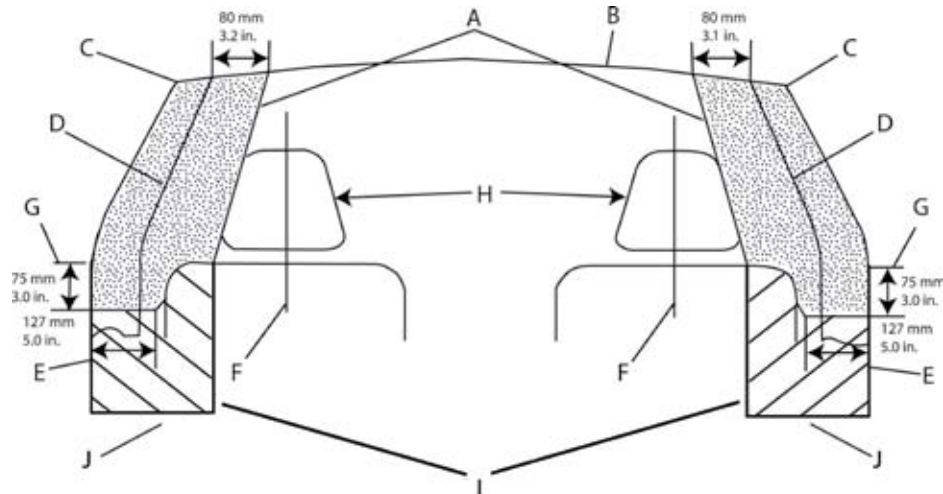

- A. Head curtain air bag deployment zone
- B. Underside of headliner
- C. Edge of headliner
- D. Inner center pillar trim
- E. Inner door pad
- F. Seat centerline
- G. Bottom of door windows
- H. Front seat headrests
- I. Seat-mounted side impact air bags deployment zone front seat
- J. Top surface of outboard front seat cushion

Head curtain side air bags are designed to help reduce the risk of head and neck injuries to front and rear seat occupants on the near side of certain side-impact collisions. Always use safety belts and the correct child restraints for your child's age and size, even in vehicles equipped with air bags. Children are safer when properly secured in a rear seat. See your vehicle Owner's Manual and child safety seat instructions for more information.

GM offers Anti-Lock Brake Systems as standard or optional on all North American passenger vehicles and light truck lines. The computerized Anti-Lock Braking System (ABS) is designed to keep the vehicle's wheels rotating as the brakes are applied to assist the driver in achieving a controlled stop. Sensors monitor how fast the wheels rotate and feed the data continuously to the ABS computer. The vehicle's brakes slow each wheel as the brake pedal is applied. However, when ABS is activated due to road conditions, the system repeatedly releases and applies pressure to the brakes. The wheels can keep rolling, thus retaining steering ability and enhanced stability while providing a higher braking force on most surfaces than a locked wheel provides.

How exactly does ABS work?

In cars without ABS, hitting the brakes can cause the wheels to lock, leaving you unable to steer the vehicle until you decrease the pressure so the wheels can roll again. With an ABS, as you apply the brakes, the ABS computer monitors the wheel speed sensor information. If the computer senses that a wheel is approaching lock up, it sends a signal to the hydraulic modulator to reduce, then to reapply, brake pressure several times a second for as long as you maintain firm pressure on the brake pedal. The process is much like the threshold braking technique used with conventional brakes. However, ABS does it much faster and more accurately than any driver can, leaving you free to focus on steering away from obstacles.

Does ABS reduce stopping distances?

Yes, in braking situations where the wheels on a non-ABS equipped vehicle would lock up, ABS will generally provide shorter controlled stopping distance. The amount of improvement in stopping distance depends on many factors, including the road surface, severity of braking, initial vehicle speed, etc. On some surfaces, such as gravel roads, braking distances can be longer, but you will still have the control benefits of ABS. The important capability of ABS is control. ABS provides improved vehicle steerability and stability when braking.

What can affect the ABS advantage?

It is important that you follow the maintenance schedule recommended in the owner's manual of the vehicle, tires should be at their proper inflation level, the brake pads should be checked regularly, etc. While driving, you should sit comfortably, so that your hips are back in the seat and your knees are bent, even while braking. Your foot should be positioned so that your heel is on the floor and your toes are secure on the lower half of the pedal. And, though ABS may reduce stopping distance, remember: The faster you go, the longer it takes you to stop. Keeping a safe distance between you and the vehicle in front of you is always necessary, even with ABS.

What happens if ABS becomes inactive?

The ABS electronic control unit has on-board diagnostic capability. If a fault is detected, the vehicle will revert to the base brake system, and the ABS telltale on the dash will be illuminated. Should this happen, the vehicle should be taken to a dealership for repair as soon as possible.

How do I use ABS?

Depress and hold the pedal. DO NOT PUMP THE BRAKES (that prevents the system from working). Just hold the brake pedal down and let the ABS work for you. You may feel the brake pedal vibrate, or you may notice some noise, but this is normal as the system works for you.

Should I drive an ABS equipped vehicle differently than I would drive a vehicle with conventional brakes?

Most of the time, under normal driving circumstances, there is no difference, and you should always drive with the same caution and care. It is important to realize that ABS only makes a difference when it is activated—when you have to brake hard—and that would only be when the computer senses that a wheel is approaching lock up. When ABS activates keep steady pressure on the brake pedal and then let the ABS work for you. Don't pump the brakes or try to find the threshold. Simply hold the brake pedal down and steer if necessary to avoid an obstacle.

Is ABS always active?

ABS is always available, but not always activated. ABS is activated only when the brake pedal is applied and the computer detects an impending wheel lock condition.

Can older cars be retrofitted with ABS?

No! The brake system is one of the most important features on any passenger vehicle. Several products, which tap into the master cylinder and/or brake system performance, are being sold in the aftermarket. Some of these products imply performance similar to new vehicle anti-lock brake systems.

However, contrary to their claims, add-on systems, which deplete fluid from the master cylinder on brake apply may actually increase a vehicle's stopping distance. This may cause the vehicle to fail to comply with Federal brake standards.

Does ABS always activate at the same speed?

No, the system operates when the computer detects wheel lockup, at any speed above 8 mph.

Will ABS wear out a vehicle's brakes sooner?

A properly maintained brake system will be unaffected by ABS operation under typical driving conditions.

Are there different types of ABS?

Yes, there are rear wheel anti-lock systems (RWAL) used on some trucks and four-wheel ABS available on cars and trucks.

Do Federal Safety Standards mandate ABS?

No. Federal standards establish minimum braking performance requirements that all vehicles must meet, but do not specify how they should be met. It should be noted that even a vehicle with failed ABS meets the Federal safety standard for stopping distances.

Will a tire size change affect ABS?

Use of tires other than original equipment may affect ABS performance. Owners should consult and follow the recommendations contained in the vehicle owner's manual regarding replacement tire size. *Note: ABS will work with original equipment spare tire or tire chains. However, performance is reduced.*

Do insurance companies give a discount for ABS?

Yes, many insurance companies give discounts that range from 5% to 10%. In the states of New York and Florida all insurance companies are required to give an ABS discount of 5% on certain coverages such as bodily injury, property damage, collision, and personal injury protection. In other states the discount varies from insurance company to insurance company. When buying auto insurance, always ask your insurance agent if his/her company gives a discount for vehicles equipped with anti-lock brakes.



IMPORTANT DRIVING SAFETY TIPS



- A. Always maintain a safe following distance.** ABS does not allow you to stop on a dime. (Generally a 2-second following distance is considered safe in ideal conditions.) Watch the vehicle in front of you pass a fixed marker (such as a sign). Count seconds—one-thousand-one, one-thousand-two—until your front bumper reaches the marker. If you do not count out two seconds, then you are too close to the vehicle in front of you. Also, if the roads are wet or icy, or visibility is poor, you should increase your following distance.
- B. Always drive carefully—** especially on slippery surfaces. ABS cannot create friction between the tires and the road surface, it can only give the driver the maximum advantage of the existing adhesion. If the vehicle is traveling on a surface with no adhesion, the best ABS in the world cannot provide a shorter stopping distance or good steering.
- C. It is a good idea to practice an ABS activated stop** and get the feel of the brake pedal. However, please make sure it's at a safe time with no obstacles in your path. And you only really need to try it once or twice to know what happens.

ELECTRONIC STABILITY CONTROL SYSTEMS (STABILITRAK)

StabiliTrak systems help drivers maintain control of their vehicles, especially during emergency lane changes or avoidance maneuvers. StabiliTrak uses various sensors, such as steering wheel angle, wheel speed, yaw velocity, etc., to detect any difference between the path requested by the steering wheel position and vehicle's actual path. When appropriate, the system selectively controls brakes, engine power, and even suspension settings to enhance control of the vehicle's direction and help keep it on course. Independent studies conducted by the National Highway Traffic Safety Administration, the Insurance Institute for Highway Safety, and others have found StabiliTrak to be highly effective in reducing vehicle crashes. General Motors offers StabiliTrak systems on many of its passenger car and light truck models. See your owner's manual for additional information about the operation of StabiliTrak.

Q. How do I use StabiliTrak?

A. StabiliTrak operates independently of the driver. You should continue to drive your StabiliTrak equipped vehicle with caution and care. GM's StabiliTrak system, StabiliTrak, is designed to be as seamless as possible in operation, to be part of the overall vehicle response and to make a good vehicle better

Q. How does StabiliTrak work?

A. StabiliTrak has the ability to apply control forces to the vehicle independent of the driver. StabiliTrak uses sensors to continuously compare the path indicated by the steering wheel position to the vehicle's actual path. If a discrepancy is detected, StabiliTrak selectively controls vehicle brakes and engine torque to create a yaw moment that helps restore the vehicle's actual path to the path indicated by the steering wheel position. StabiliTrak has the ability to help correct both understeer (where the vehicle is not turning as much as the steering wheel position indicates) and oversteer (where the vehicle is turning more than the steering wheel position indicates). The illustration at right shows how selective braking at a particular wheel can create a compensating yaw moment to help restore the vehicle's actual path to the path indicated by the steering wheel position.

Q. Will a tire change affect StabiliTrak?

A. Use of tires other than original equipment may affect StabiliTrak performance. StabiliTrak is designed to make the best use of available traction. The performance characteristics of the original equipment tires are part of the overall system effectiveness. When you replace tires check the recommendations in your Owners Manual. On GM vehicles, the original equipment tires have a "TPC" (Tire Performance Criteria) code on the sidewall. Replacing the tires with the same "TPC" code will help assure proper StabiliTrak performance.

UPDATES FOR 2012



FIRST ISSUE IN TECHNICAL MANUAL

2 | SILVERADO 1500 CREW CAB PICKUP HYBRID - 1HY

Note: This vehicle is NOT designed nor intended for use IN HIGH SPEED EMERGENCY VEHICLE OPERATIONS

MODEL AVAILABILITY

CC10543	2-wheel drive, Crew Cab Short Box Pick Up (also available in 2HY model/not shown see your dealer for more information)
CK10543	4-wheel drive, Crew Cab Short Box Pick Up (also available in 2HY model/not shown see your dealer for more information)

STANDARD EQUIPMENT SUMMARY

WARRANTY	3 years / 36,000 mile bumper-to-bumper (whichever comes first, see dealer for details) 8 years / 100,000 mile limited powertrain (whichever comes first, see dealer for details)
----------	---

INTERIOR FEATURES

AIR CONDITIONING	Dual-zone automatic climate control with individual climate settings for driver and front passenger)
AUDIO SYSTEM	AM/FM stereo with MP3 compatible CD player, seek-and-scan digital clock, auto-tone control, Radio Data System (RDS), speed-compensated volume, TheftLock, includes 6 speakers
BLUETOOTH FOR PHONE ¹⁰	Personal cell phone connectivity to vehicle audio system
CONSOLE	Floor (not available)
CRUISE CONTROL	Electronic with set and resume speed
DRIVER INFORMATION CENTER	Odometer, trip odometer and message center (monitors numerous systems depending on vehicle equipment level including low fuel, turn signal on, transmission temperature and oil change notification) includes 8-point compass and outside temperature
FLOOR COVERING	Color-keyed carpeting with rubberized vinyl floor mats (includes rear floor mats)
GLASS	Solar-Ray deep tinted (all windows except light-tinted glass on windshield, driver and front passenger side glass includes rear quarter windows)
LIGHTING	Interior with dome and reading lights, illuminates entry feature and backlit instrument panel switches
MIRROR	Inside rearview auto-dimming
ONSTAR ⁸	6-months of Directions and Connections plan. Includes Automatic Crash Response, Emergency Services, Crisis Assist, Stolen Vehicle Assistance featuring Stolen Vehicle Slowdown, Remote Door Unlock, Roadside Assistance, Remote Horn and Lamps, innovative easy to use Turn-by-Turn Navigation with Destination Download and OnStar eNav (where available), available Hands Free Calling, OnStar Vehicle Diagnostics, and Low Mileage Discount
POWER OUTLETS	2 auxiliary instrument panel mounted with covers 12 volt
REMOTE VEHICLE STARTER PREP PACKAGE	Remote vehicle starter prep package, includes remote keyless entry (to enable remote start capability, new key fobs and vehicle reprogramming are required, please see your dealer for details)
RESTRAINT SYSTEM	5-star frontal and side crash test rating (driver and front passenger) from NHTSA¹². Safety belts, driver and front passenger with pretensioners, dual stage driver and passenger frontal air bags ¹ , passenger sensing system and frontal air bag ¹ ON/OFF indicator, rollover sensor, dual head curtain air bags ¹ for first and second row outboard occupants and front seat back mounted thorax-pelvic air bags ¹
SEAT, FRONT	Cloth 40/20/40 split-bench, 3-passenger, driver and front passenger manual reclining, center fold-down armrest with storage, lockable storage compartment in seat cushion (includes auxiliary power outlet), adjustable outboard head restraints and storage pockets. Manual lumbar control on driver side
SEAT, REAR	Full-width fold-in bench, 3-passenger (includes child seat top tether)
STEERING COLUMN	Tilt-wheel, adjustable with brake/transmission shift interlock
STEERING WHEEL	Leather wrapped with theft deterrent locking feature
STEERING WHEEL CONTROLS	Mounted audio controls
VISORS	Driver and front passenger, sliding with clip and illuminates vanity mirror on driver and passenger-side, opal gray-colored
WARNING TONES	Headlamp on, key-in-ignition, driver and right-front passenger safety belt unfasten and turn signal on
WINDOW OPERATION	Power with driver express-down

ELECTRICAL FEATURES

HYBRID PROPULSION	Electric 2-mode
-------------------	-----------------

1. Head curtain side air bags are designed to help reduce the risk of head and neck injuries to front and rear seat occupants on the near side of certain side-impact collisions. Always use safety belts and the correct child restraints for your child's age and size, even in vehicles equipped with air bags. Children are safer when properly secured in a rear seat. See your vehicle Owner's Manual and child safety seat instructions for more information.
8. Visit OnStar.com for coverage map, system limitations and details.
9. XM Radio requires a subscription, sold separately by XM after the trial period. Not available in Canada, Alaska or Hawaii. For more information, visit gm.xmradio.com.
10. Go to gm.com/bluetooth to find out which Bluetooth phones are compatible with the vehicle.
12. Model tested with standard head curtain side-impact air bags (SABs). Government 5-Star Safety ratings are part of the National Highway Traffic Safety Administration's (NHTSA's) New Car Assessment Program (www.SaferCar.gov).

SILVERADO 1500 CREW CAB PICKUP HYBRID - 1HY₁₃

EXTERIOR FEATURES

ASSIST STEPS	Black, mounted between front and rear wheels
BODY SIDE MOLDINGS	Body-colored
BUMPER-FRONT	Chrome (includes body-color bumper top caps. Chrome bumper replaces with black bumper bar when SEO 1TR base appearance for hybrid is ordered)
BUMPER-REAR	Chrome, step-style with pad
DEFOGGER	Electric, rear window
DOOR HANDLES	Color - keyed
DOOR LOCKS	Power, child safety locks included in rear doors
GRILL	Chrome surround
HEADLAMPS	Dual halogen composite with flash-to-pass feature, automatic exterior lamp control and daytime running lamps
MIRRORS	Outside heated power-adjustable, black, manual folding
RECOVERY HOOKS	Front frame mounted (4WD only)
REMOTE KEYLESS ENTRY	Remote keyless entry and remote vehicle Starter Prep Package
PICKUP BOX	Fleetside
TAILGATE	EZ-lift, locking
WINDSHIELD WIPERS	Intermittent wet-arm with pulse washers
WIPER	Rear intermittent with washer

CHASSIS FEATURES

AIR CLEANER	High-capacity
AXLE	3:08 axle ratio
BATTERY	Heavy-duty 600 cca, maintenance-free with rundown protection and retained accessory power, hybrid 300-volt energy storage system located under the 2nd row seat cushion
BRAKES	4-wheel antilock, 4-wheel disc, electro-hydraulic power with StabiliTrak, regenerative system
COOLING	Electric fans and extended life coolant; coolant hoses are EPDM (ethylene-propylene-diene monomer) rubber
DIFFERENTIAL	Heavy-duty automatic locking rear
ENGINE	Vortec 6.0L V8 SFI, LIVC with active fuel management
FRAME	Full perimeter modular with hydroformed frame rails
FUEL TANK CAPACITY	26 gallon (98 liters)
OIL COOLERS	Engine and transmission auxiliary air-to-oil and power steering
REGENERATIVE BRAKING	Uses the hybrid propulsion motors in the transmission acting as a generator to decelerate the vehicle by applying resistance while capturing the energy as electricity in the 300V Energy Storage System, which is then available for the next acceleration cycle
STABILITRAK	Stability control system with proactive roll avoidance and traction control
STEERING	Power rack-and-pinion
SUSPENSION, FRONT	Independent coil-over-shock
SUSPENSION, REAR	2 stage multi-leaf springs, semi-ecliptic
SUSPENSION PACKAGE	Handling/trailer, heavy duty, includes 46mm piston monotube shocks and 36mm front stabilizer bar
TIRES	P265/65R18 all-season, blackwall
TIRE PRESSURE MONITOR	Tire Pressure Monitor System (does not apply to spare tire)
TIRE, SPARE	Full-size spare, with outside winch-type carrier mounted under frame at rear includes tire lock keyed cylinder lock that utilizes same as key as ignition
TRAILERING EQUIPMENT	Heavy-duty, includes trailering hitch platform 2-inch receiver, 7-wire harness (harness includes wires for park lamps, backup lamps, right turn, left turn, electric brake lead, battery and ground) with independent fused trailering circuits mated to a 7-way sealed connector and wiring harness for aftermarket trailer brake controller (located in the instrument panel harness)
TRANSFER CASE	Electronic Autotrac with rotary dial controls (requires 4WD)
TRANSMISSION	2-mode strong hybrid, automatic, electronic
WHEELS	18" x 8" (45.7cm x 20.3cm) chrome-clad aluminum (includes 17" (43.2cm) aluminum spare wheel will not cosmetically match the other 4 wheels)

4 | SILVERADO 1500 CREW CAB PICKUP HYBRID - 1HY

AUTOMATIC TRANSMISSION - WITH BALL HITCH

MODEL	(LZ1) VORTEC 6.0L V8 SFI	
	AXLE RATIO	MAXIMUM TRAILERING ⁷
CC10543	3.08	6100/2767
CK10543	3.08	5900/2676

*Silverado 1500 models are limited to 5000 lb. trailer rating unless equipped with (Z85) Handling/Trailer Suspension Package, (Z60) High-Performance Suspension Package or (Z71) Off-Road Suspension Package.
Addition of trailer tongue weight cannot cause vehicle weights to exceed Rear Gross Axle Weight Rating (RGVWR) of Gross Vehicle Weight Rating (GVWR).
(Z82) Trailing Equipment, heavy-duty includes trailer hitch platform, trailer electrical connector and suspension upgrade if necessary.*

GCWR - FOR ENGINE/REAR AXLE RATIO COMBINATION WITH AUTO TRANS

ENGINE	(GCWR) GROSS COMBINATION WEIGHT RATINGS LBS (KG)
LZ1 VORTEC 6.0L V8 SFI	3.08

POWERTRAIN

MODEL	ENGINE	TRANSMISSION M99 4-SPEED AUTOMATIC WITH OD HYBRID-SPECIFIC	AXLE GU4 3.08	GVWR	
				C5Y 7100 (3221)	C6A 7300 (3311)
CC10543	LZ1 Vortec 6.0L V8 SFI	S	S	S	-
CK10543	LZ1 Vortec 6.0L V8 SFI	S	S	-	S

EMISSIONS - MUST BE SPECIFIED

FE9	FEDERAL EMISSIONS. Use for ordering vehicles that will be registered in all states except California, Connecticut, Maine, Maryland, Massachusetts, New Jersey, New Mexico, New York, Oregon, Pennsylvania, Rhode Island, Vermont and Washington State
YF5	CALIFORNIA EMISSIONS. Use for ordering vehicles that will be registered in California.
NE1	CT/ME/MD/MA/NJ/NM/NY/OR/PA/RI/VT/WA EMISSIONS. Use for ordering vehicles that will be registered in Connecticut, Maine, Maryland, Massachusetts, New Jersey, New Mexico, New York, Oregon, Pennsylvania, Rhode Island, Vermont or Washington State
NB8	Required when option code FE9 "FEDERAL EMISSIONS" is ordered for delivery to a dealer located in California, Connecticut, Massachusetts, Maryland, New Jersey, New Mexico, New York, Oregon, Pennsylvania, Rhode Island and Washington State for a purchaser who will be registering the vehicle outside California, Connecticut, Maine, Maryland, Massachusetts, New Jersey, New Mexico, New York, Oregon, Pennsylvania, Rhode Island, Vermont and Washington State.
NC7	Required when option code YF5 "CALIFORNIA EMISSIONS" or option code NE1 "CT/ME/MD/MA/NJ/NM/NY/OR/PA/RI/VT/WA EMISSIONS" is ordered for delivery to a dealer located in any state except California, Connecticut, Maine, Maryland, Massachusetts, New Jersey, New Mexico, New York, Oregon, Pennsylvania, Rhode Island, Vermont and Washington for a purchaser who will be registering the vehicle in one of these states or sold as permitted below under "EPA Policy on the Sale of California Emission Vehicles"
NB9	Required when option code YF5 is ordered for delivery to a dealer located in Connecticut, Maine, Maryland, Massachusetts, New Jersey, New Mexico, New York, Oregon, Pennsylvania, Rhode Island, Vermont and Washington. Required when option code NE1 is ordered for delivery to a dealer located in California.

SILVERADO 1500 CREW CAB PICKUP HYBRID - 1HY₁₅

TIRES

CODE	QUANTITY	SIZE	SPEED RATING	TYPE
QXK	5	P265/65R18	S	All season BW





SEATS AND INTERIOR TRIM

	SEAT CODE	SEAT TRIM	EBONY	LIGHT TITANIUM/ DARK TITANIUM	LIGHT CASHMERE/ DARK CASHMERE
STANDARD Front: 40/20/40 split-bench, 3-passenger, driver and front passenger manual reclining, center fold-down armrest with storage, compartment in seat cushion (includes auxiliary power outlet), adjustable outboard head restraints and storage pockets	AZ3	Premium Cloth	19C	83C	33C
Rear: Full-width folding bench, 3 passenger (includes child seat to tether anchor)	AM7				

GCWR - ENGINE/REAR AXLE RATIO COMBINATION WITH AUTO TRANSMISSION

ENGINE	(GCWR) GROSS COMBINATION WEIGHT RATINGS lbs. (kg)
(LZ1) Vortec 6.0L V8 SFI	12,000/5,443
	3.08

AVAILABLE EXTERIOR COLORS

					
37U Imperial Blue* Metallic	46U Blue Granite Metallic	GAN Silver Ice* Metallic	41U Black	50U Summit White	74U Victory Red Tintcoat

*Actual colors may vary * Not available until 4th quarter 2011*

SPECIFICATIONS (in./mm)		
LOCATION	CC10543 2WD CREW CAB SHORT BOX	CK10543 4X4 CREW CAB SHORT BOX
Wheelbase	143.50/3645	143.50/3645
Overall length	229.90/5839	229.90/5839
Body width	79.96/2031	79.96/2031
Overall height	73.80/1875	73.70/1872
Head room, front	41.50/1054	41.50/1054
Head room, rear	40.60/1031	40.60/1031
Shoulder room, front	65.20/1656	65.20/1656
Shoulder room, rear	65.20/1656	65.20/1656
Hip room, front	62.50/1588	62.50/1588
Hip room, rear	65.50/1664	65.50/1664
Leg room, front	41.30/1049	41.30/1049
Leg room, rear	38.70/983	38.70/983
Cab to axle	32.00/813	32.00/813
Front bumper to axle	39.40/1001	39.40/1001
Rear bumper to axle	47.20/1199	47.20/1199
Inside length, at floor	69.30/1760	69.30/1760
Inside height	21.00/533	21.00/533
Inside width, at floor	62.50/1588	62.50/1588
Tailgate width, top	61.60/1565	61.60/1565
Front bumper to back of cab	148.90/3782	148.90/3782
Ground to top of rear load floor	32.90/836	32.70/831
Inside width, between wheelhousing	50.60/1285	50.60/1285
Ground clearance, front	9.00/229	9.00/229
Ground clearance, rear	12.30/312	12.10/307
Front shock absorber diameter, in. (mm)	1.81/46	1.81/46
Front stabilizer bar diameter, in. (mm)	1.42/36	1.42/36
Rear shock absorber diameter, in. (mm)	1.81/46	1.81/46
Turning diameter, curb-to-curb, ft. (m)	47.2/14.4	47.2/14.4
Front axle, lbs. (kg)	3650/1656	3950/1792
Front spring capacity, lbs. (kg)	3650/1656	3950/1792
Rear axle, lbs. (kg)	3950/1792	4000/1814
Rear spring capacity, lbs. (kg)	3950/1792	3950/1792
Curb weight, lbs. (kg)	5548/2517	5781/2622
Cargo volume ³ , cargo box, cu. ft. (liters)	53.2/1506.6	53.2/1506.6
Payload ⁶ , lbs. (kg)	1553/704	1519/689
Gross Vehicle Weight Rating ⁵ (GVWR), lbs. (kg)	7100/3221	7300/3311
Front Gross Axle Weight Rating (FGAWR), L96, lbs. (kg)	3650/1656	3950/1792
Rear Gross Axle Weight Rating, lbs. (kg)	3950/1792	3950/1792
Fuel capacity, approximate, gallon (liters)	26/98	26/98
Seating capacity	3/3	3/3
Fuel economy (city/hwy/combined)	20/23/21	20/23/21

Note: Published dimensions indicated are without optional equipment or accessories. Additional accessories or equipment ordered at the customer's request can result in a minor change in these dimensions.

71 SILVERADO 1500 CREW CAB PICKUP HYBRID - 1HY

AVAILABLE OPTIONS WITH HYBRID MUNICIPAL PACKAGE – 1HY

1TR	BASE APPEARANCE for Hybrid Includes grille with Black surround, Black bumper bar and end caps, N87 Aluminum wheels 18" x 8" (45.7 cm x 20.3 cm). Requires a Fleet or Government sales order
RW1	BED RAIL PROTECTORS - Dealer installed
VK3	LICENSE PLATE BRACKET - Front (will be forced orders that require front license plate)
VAV	MATS ALL-WEATHER FLOOR - First and second row (LPO dealer installed)
UED	ONSTAR DELETE - Deletes bluetooth for phone
R8G	ONSTAR - 1 Additional Year of OnStar Safe and Sound Service. Provides 1 year of Safe and Sound service in addition to the 6 months of standard Directions and Connections service that is included in the price of the vehicle. Total service duration is 18 months. Fleet may also order RFA OnStar Business Vehicle Manager Service, requires UE1 OnStar. Requires one of the following Fleet or Government order types: FLS, FNR, FRC, FBC, FGO or FEF. Not available with R8P, R8W, R8Y, R8Z or RFG
R8W	ONSTAR - 2 Additional Years of OnStar Safe and Sound Service. Provides 2 years of Safe and Sound service in addition to the 6 months of standard Directions and Connections service that is included in the price of the vehicle. Total service duration is 30 months. Fleet may also order RFA OnStar Business Vehicle Manager Service, requires UE1 OnStar. Requires one of the following Fleet or Government order types: FLS, FNR, FRC, FBC, FGO or FEF. Not available with R8G, R8P, R8Y, R8Z or RFG
R8P	ONSTAR - 30 Additional Months of OnStar Safe and Sound Service. Provides 30 months of Safe and Sound service in addition to the 6 months of standard Directions and Connections service that is included in the price of the vehicle. Total service duration is 36 months. Fleet may also order RFA OnStar Business Vehicle Manager Service, requires UE1 OnStar. Requires one of the following Fleet or Government order types: FLS, FNR, FRC, FBC, FGO or FEF. Not available with R8G, R8W, R8Y, R8Z or RFG
R8Y	ONSTAR - 1 Additional Year of OnStar Directions and Connections Service. Provides 1 year of Directions and Connections service in addition to the 6 months of standard Directions and Connections service that is included in the price of the vehicle. Total service duration is 18 months. Fleet may also order RFA OnStar Business Vehicle Manager Service, requires UE1 OnStar. Requires one of the following Fleet or Government order types: FLS, FNR, FRC, FBC, FGO or FEF. Not available with R8G, R8W, R8P, R8Z or RFG
R8Z	ONSTAR - 2 Additional Years of OnStar Directions and Connections Service. Provides 2 years of Directions and Connections service in addition to the 6 months of standard Directions and Connections service that is included in the price of the vehicle. Total service duration is 30 months. Fleet may also order RFA OnStar Business Vehicle Manager Service, requires UE1 OnStar. Requires one of the following Fleet or Government order types: FLS, FNR, FRC, FBC, FGO or FEF. Not available with R8G, R8W, R8P, R8Y or RFG
RFA	ONSTAR - Business Vehicle Manager Service. Provides OnStar Business Vehicle Manager Service equal to the length of OnStar multi-year order. Must be ordered to receive service requires UE1 OnStar. Requires one of the following Fleet or Government order types: FLS, FNR, FRC, FBC, FGO or FEF. Requires Fleet Master Agreement (FMA)
RFG	ONSTAR - 30 Additional Months of OnStar Directions and Connections Service. Provides 30 months of Directions and Connections service in addition to the 6 months of standard Directions and Connections service that is included in the price of the vehicle. Total service duration is 36 months. Fleet may also order (RFA) OnStar Business Vehicle Manager Service requires UE1 OnStar. Requires one of the following Fleet or Government order types: FLS, FNR, FRC, FBC, FGO or FEF. Not available with R8G, R8W, R8P, R8Y or R8Z.
AG1	SEAT ADJUSTER - Driver 6-way power
N87	WHEELS - 4 - 18" x 8" (45.7 cm x 20.3 cm) aluminum. 17" (43.2 cm) aluminum spare (spare wheel will not cosmetically match the other 4 wheels) Included and only available with SEO (1TR) Base Appearance for Hybrid

8. Visit OnStar.com for coverage map, system limitations and details.

9. XM Radio requires a subscription, sold separately by XM after the trial period. Not available in Canada, Alaska or Hawaii. For more information, visit gm.xmradio.com.

Can specialty vehicle equipment (e.g. radar devices, video cameras, computers, meters, radio trees, shotguns, etc.) still be mounted in cars with passenger side air bags?

Yes, but care must be taken to mount the equipment outside of the deployment zone. Air bags inflate with great force and will interact with any object in the deployment zone. Therefore, to reduce the risk of injury to vehicle occupants, GM recommends that the air deployment zone be kept free of any equipment. If a piece of equipment were to become dislodged it could strike an occupant in the vehicle and result in injury. The likelihood of an object becoming dislodged is influenced by many factors, including the proximity of the object to the inflatable restraint, the size and shape of the object, and the means by which the object is secured to the vehicle. In addition to these factors, the trajectory and velocity of a dislodged object can be influenced by the type and severity of vehicle crash.

Objects that are in the deployment zone, but do not become dislodged by an inflating air bag can still affect the performance of the air bag. For example, such objects could tear the fabric or affect the shape of the air bag, thus reducing the ability of the bag to provide restraint.

Is it possible to shield equipment that is installed in the passenger side frontal air bag deployment zone in a manner that will allow full and safe air bag deployment?

Due to the complexity of influencing variables, GM is unable to evaluate the potential for shielding expected equipment configurations in all accident scenarios in order to assure that the air bag performance would be unaffected. While shielding may protect certain equipment from being damaged or dislodged, it may also negatively affect the inflation characteristics of the air bag. The air bag's shape, inflation angle, fold pattern, and inflation rate and pressure are developed to maximize the protection capability of the inflatable restraint system. Therefore, GM cannot recommend the placement of any equipment in the deployment zone, even if it is shielded to protect it from damage.

Front air bag systems and instrument panel mounted equipment.

Passenger air bags in GM vehicles deploy in different ways depending upon the type of vehicle and the particular instrument panel design.

In some vehicles, the passenger air bag deploys through a discrete door located on the top surface of the instrument panel (top-mount air bag systems). In other vehicles, such as the Chevrolet Tahoe, the passenger air bag deploys through a discrete door mounted on the vertical rearward surface of the instrument panel, above the glove box door (mid-mount air bag system). With these types of top-mount and mid-mount passenger air bag systems, the top pad of the instrument panel remains in place during deployment.

Some GM passenger air bag systems, like the system in the Chevrolet Impala, deploy from beneath the instrument panel top pad. These are considered 3/4-mount air bag systems with a "deployable top pad." The entire instrument panel top pad is the "deployment door" from under which the inflating air bag emerges. When an air bag deployment is commanded, the forces from the inflating passenger air bag push up on the instrument panel top pad, releasing special fasteners across the rearward edge of the top pad. This allows the top pad to rotate upward so that the passenger air bag may emerge. The top pad rotates upward to open widest at the right hand side, and is usually forced upward into contact with the windshield on the right hand side of the vehicle during a deployment.

Head curtain side air bags are designed to help reduce the risk of head and neck injuries to front and rear seat occupants on the near side of certain side-impact collisions. Always use safety belts and the correct child restraints for your child's age and size, even in vehicles equipped with air bags. Children are safer when properly secured in a rear seat. See your vehicle Owner's Manual and child safety seat instructions for more information.

Instrument panel top mounted special equipment, such as a radar antenna and control unit or video camera must be positioned to the left of the vehicle center line. This equipment must be mounted as low as possible and securely fastened to the top pad to avoid being dislodged in the event of a crash and possible air bag deployment. In the process of securely fastening special equipment to the top, DO NOT fasten down the top pad itself to any other vehicle component such as the cluster trim plate. As described above, the top pad rotates upward during a deployment. In order to enable the proper deployment of the passenger air bag, specialty equipment installation MUST NOT PREVENT the top pad from rotating upward during deployment. Location and attachment of special equipment should minimize added resistance or interference to upward rotation of the top pad during deployment.

Optional side air bags for crashes to the vehicle sides.

The air bag system in your police vehicle may include optional side air bags for front and rear occupants. Most front-to-rear side air bags are designed to deploy downward from the interior roof sides to the bottom of the door windows.

Can Specialty Vehicle Security Barriers be mounted within the side air bag deployment zones?

No. The side air bags inflate extremely fast because of the nature of side crashes to the vehicle. Mounting a security barrier behind the front seats with the ends placed within the side air bag deployment zones will result in unintended interaction between the barrier and the inflating side air bags. To reduce the risk of injury to the vehicle occupants, GM recommends that the side air bag zones be kept free of any customer installed equipment.

Customer furnished equipment installed to the vehicle roof.

Your police vehicle is designed with an interior roof cover system which includes internal components for the interior lamps and wiring. The roof system may also include optional side air bag components. Inflation devices may be mounted on the vehicle roof side behind the rear doors as well as air bag tethers retained to the windshield pillars. Care must be taken to avoid damage to these components or interference with their operation when installing roof mounted equipment such as emergency lamps and communication antennas.

Recommended GM service procedures must be followed to remove and re-install the instrument panel top pad to ensure that the top pad will release properly in the event of a passenger air bag deployment.

On the right half of the top pad closest to the passenger air bag module, GM recommends that no equipment be mounted. When mounting equipment on the driver side of the top pad, GM recommends that the total mass of the top pad mounted special equipment not exceed 8 pounds (3.6 kilograms), since the top pad tends to rotate about the left end.

Fasteners used to secure special equipment to the instrument panel top pad, the windshield glass, or to the windshield upper frame (header), should be selected to ensure that these devices will remain attached during a vehicle crash and possible air bag deployment.

Can the installation of push bumpers on the front end of the vehicle affect the deployment of the air bag?

General Motors is not aware of adverse effects during crash events from the many push bumpers that have been installed on GM police vehicles. Because there are many styles of push bumpers available with varying crash characteristics, installation of push bumpers may or may not affect deployment timing of the air bags. Push bumpers should be mounted to avoid modifying the vehicle structure and interfering with the front air bag sensors mounted on the upper radiator support cross member.

Two front impact sensors are installed in General Motors vehicles. Do not relocate or disconnect the front sensors. The location and orientation of the front sensors are critical for correct operation of the air bag system. Avoid mounting components on or near the sensors. Push bumper styles with vertical pushing members that are in fore-aft alignment with the front air bag sensors are not recommended.

How long will the air bag remain inflated?

It takes approximately 1/20th of a second to fully inflate the frontal air bags. This is faster than the blink of an eye. The air bags begin to deflate immediately, helping to stop the occupants more gradually.

Can the air bag system be re-used?

No. The air bags are designed to inflate only once. After inflation some new parts will be required. These will include the air bag module and possibly other parts. (A competent service technician with access to the vehicle's service manual and the required tools should replace the required components after a deployment crash.)

I've heard that the dusts that are released into the passenger compartment from the air bag are harmful. Is this true?

For most people, the only effect the dusts will produce is some irritation of the throat and eyes, and that is only if the occupant remains in the vehicle for many minutes after the air bag deployment with no ventilation and windows closed. However, some people with asthma may develop an asthmatic attack from inhaling the dusts. If this happens, they should first treat themselves the same way their doctor has advised them to treat any other asthma attack, and then immediately seek medical treatment.

When should an air bag inflate?

The driver's and right-front passenger's frontal air bags are designed to inflate in moderate to severe frontal or near-frontal crashes. But they are designed to inflate only if the impact speed is above the system's designed "threshold level."

In addition, if your vehicle has "dual stage" frontal air bags, these air bags tailor the amount of restraint according to crash severity. For moderate frontal impacts, the air bags inflate at a level less than full deployment. For more severe frontal impacts, "dual stage" frontal air bags deploy at full levels.

If the front of your vehicle goes straight into a wall that doesn't move or deform, the threshold level of the reduced deployment is about 12 to 16 mph (19 to 15 km/h), and the threshold level for a full deployment is about 18 to 24 mph (29 to 28.5 km/h). The threshold level can vary, however, with specific vehicle design, so that it can be somewhat above or below this range.

If your vehicle strikes something that will move or deform such as a parked car, the threshold level will be higher. The driver's and right-front passenger's frontal air bags are not designed to inflate in rollover, side impacts, or rear impacts, because inflation would not help the occupant.

Head curtain side air bags are designed to help reduce the risk of head and neck injuries to front and rear seat occupants on the near side of certain side-impact collisions. Always use safety belts and the correct child restraints for your child's age and size, even in vehicles equipped with air bags. Children are safer when properly secured in a rear seat. See your vehicle Owner's Manual and child safety seat instructions for more information.

Seat mounted side impact air bags are designed to inflate in moderate to severe side crashes. The side impact air bags will inflate if the crash severity is above the designed "threshold level." The threshold level can vary with specific vehicles design. The side impact air bags are not designed to inflate on frontal or near-frontal impacts or rear impacts, because inflation would not help the occupant.

Roof rail mounted head-curtain air bags are designed to inflate in moderate to severe side crashes. In addition, certain vehicles have head-curtain air bags which are also designed to inflate in situations where an impending rollover condition is identified by the vehicle's rollover sensing system and/or frontal or near-frontal impacts if the crash severity is above the designed "threshold level".

Safety belt pretensioners at the driver and front passenger seat positions are designed to deploy in frontal, near-frontal, side, and rear crashes that exceed the "threshold level" of crash severity to help reduce slack in the safety belt. Safety belt pretensioners will also deploy in impending rollover situations.

I've heard that a deployed air bag produces what appears to be smoke. Is the air bag hot?

After the bag has deployed in a crash, the air bag itself will not be hot to touch. Some components within the air bag module will be hot for a short time. A small amount of smoke coming from a deployed air bag module is normal and should not be cause for concern.

Also, when the nitrogen gas is vented out of the air bag, small particles from inside the bag are also vented into passenger compartment. These airborne particles look like smoke and some particles are deposited as residue on and around the air bag.

If my vehicle has air bags, why should I have to wear my safety belt?

Air bags are in many vehicles today and will be in most of them in the future. But they are supplemental systems only; so they work with safety belts - not instead of them. Every air bag system ever offered for sale has required the use of safety belts. Even if you're in a vehicle that has air bags, you still have to buckle up to get the most protection. That's true not only in frontal collisions but especially in side and other collisions.

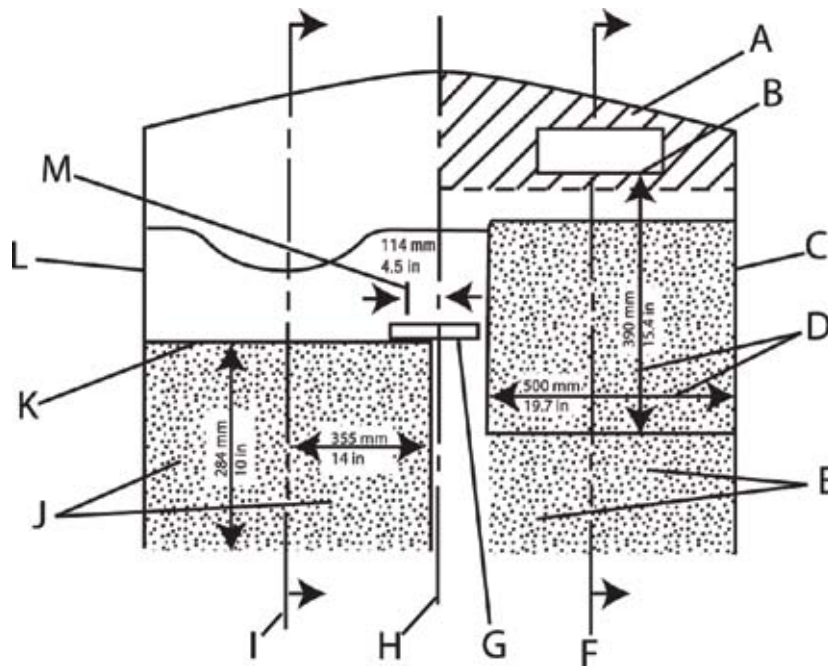

TOP VIEW OF INSTRUMENT PANEL AND APPROXIMATE DEPLOYMENT AREA OF THE AIR BAG ZONE

- A. Passenger side instrument panel top surface zone
- B. Passenger side air bag module trim panel – rear edge
- C. Passenger side door
- D. Approximate dimensions of inflated air bag
- E. Passenger side air bag deployment zone
- F. Passenger centerline
- G. Inside rearview mirror
- H. Vehicle centerline
- I. Driver centerline
- J. Driver side air bag deployment zone
- K. Front of steering wheel
- L. Driver side door
- M. Shift selector arc

Head curtain side air bags are designed to help reduce the risk of head and neck injuries to front and rear seat occupants on the near side of certain side-impact collisions. Always use safety belts and the correct child restraints for your child's age and size, even in vehicles equipped with air bags. Children are safer when properly secured in a rear seat. See your vehicle Owner's Manual and child safety seat instructions for more information.

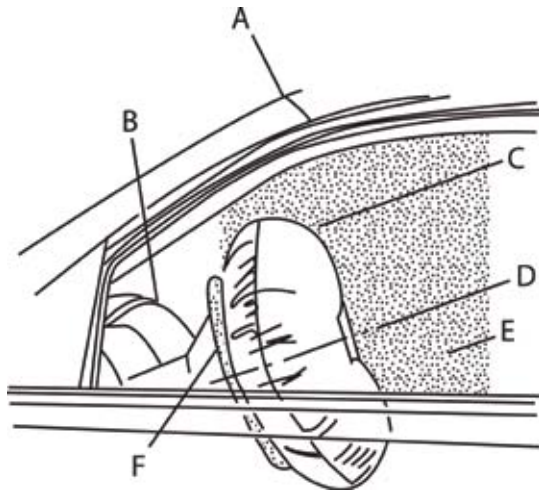

SIDE VIEW OF DRIVER SIDE AIR BAG DEPLOYMENT ZONE

- A. Top edge of windshield
- B. Top of instrument panel
- C. Inflated air bag – steering wheel
- D. Centerline of steering column at mid-tilt
- E. Driver air bag deployment zone
- F. Front of steering wheel

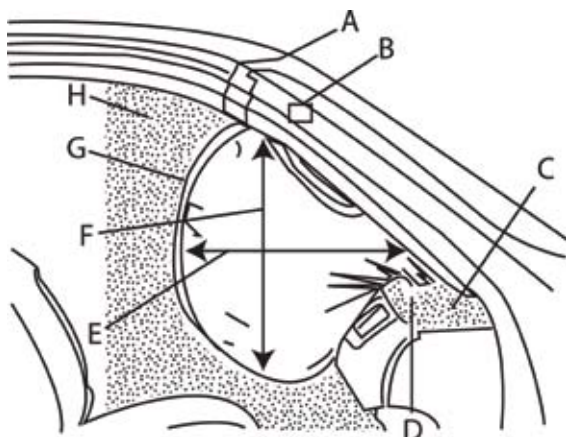

SIDE VIEW OF PASSENGER SIDE AIR BAG DEPLOYMENT ZONE

- A. Top edge of windshield
- B. Inside rearview mirror
- C. Instrument panel top surface zone
- D. Passenger side air bag module trim panel – rear edge
- E. Inflated air bag – horizontal dimension approximate 15.4 in (390 mm)
- F. Inflated air bag – vertical dimension approximate 9.3 in (490 mm)
- G. Inflated air bag – instrument panel
- H. Passenger air bag deployment zone

Head curtain side air bags are designed to help reduce the risk of head and neck injuries to front and rear seat occupants on the near side of certain side-impact collisions. Always use safety belts and the correct child restraints for your child's age and size, even in vehicles equipped with air bags. Children are safer when properly secured in a rear seat. See your vehicle Owner's Manual and child safety seat instructions for more information.

HEAD CURTAIN AND FRONT SEAT-MOUNTED SIDE IMPACT AIR BAG DEPLOYMENT ZONES PASSENGER SIDE SHOWN, DRIVER SIDE SIMILAR

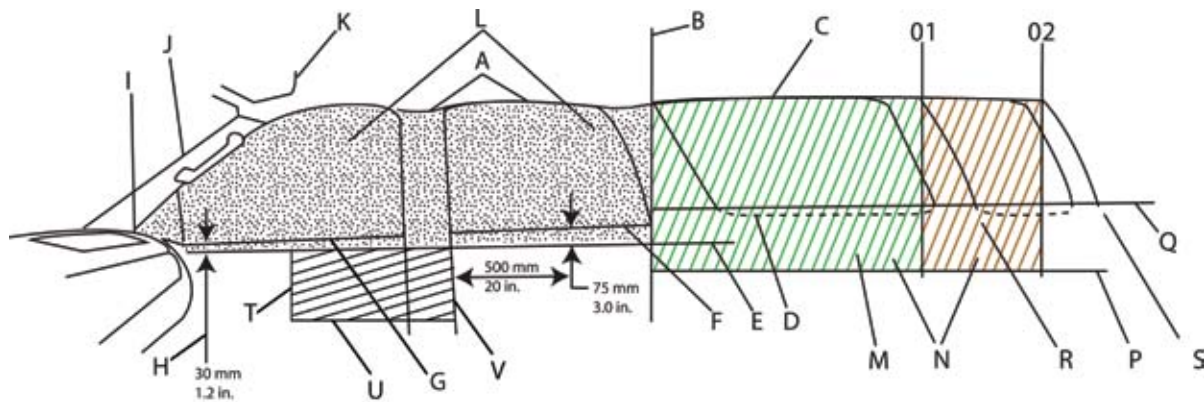

Tahoe/Suburban/Silverado Crew Cab Seat Rows 1 and 2

- A. Top of deployment zone – along head curtain at edge of headliner
- B. Back of deployment zone – at rear top corner of rear door pad
- C. Rear quarter window
- D. Bottom outside edge of rear quarter window
- E. Bottom of air bag deployment zone – parallel to outside bottom edge of rear quarter glass
- F. Top edge of rear door pad
- G. Top edge of front door pad
- H. Dimension at mirror patch from top edge of front door pad
- I. Front of deployment zone at front upper corner of front door pad
- J. Windshield pillar trim with grab handle
- K. Visor
- L. Deployment zone - Tahoe seat rows 1 and 2

Tahoe/Suburban 3rd Row Seats

- M. Deployment zone - Tahoe 3rd seat
- N. Deployment zone - Suburban 3rd seat
- O. Rear zones at back corner of headliner: 1 Tahoe, 2 Suburban
- P. Bottom of 3rd seat zone at rear side trim cup holders
- Q. Top edge of rear quarter trim at window
- R. Rear of Tahoe
- S. Rear of Suburban

Tahoe/Suburban/Silverado Crew Cab Seat Air bag

- T. Center of door trim pull handle
- U. Top of surface of outboard front seat cushion
- V. Back edge of center pillar trim

Note: The head curtain air bag inflators are mounted in a different orientation on the Silverado Crew Cab pickup truck roof structure from those in the Tahoe/Suburban.

HEAD CURTAIN AND FRONT SEAT-MOUNTED SIDE IMPACT AIR BAG DEPLOYMENT ZONES VIEW FROM REAR CARGO AREA

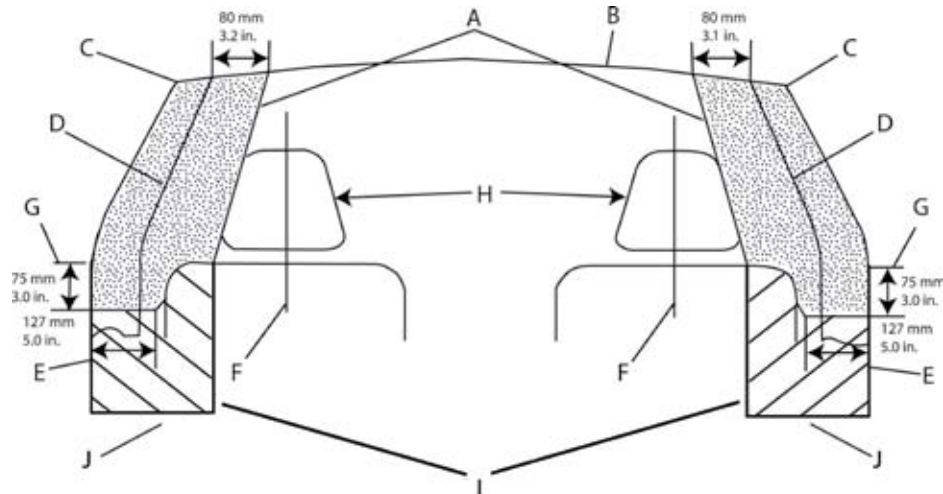

- A. Head curtain air bag deployment zone
- B. Underside of headliner
- C. Edge of headliner
- D. Inner center pillar trim
- E. Inner door pad
- F. Seat centerline
- G. Bottom of door windows
- H. Front seat headrests
- I. Seat-mounted side impact air bags deployment zone front seat
- J. Top surface of outboard front seat cushion

Head curtain side air bags are designed to help reduce the risk of head and neck injuries to front and rear seat occupants on the near side of certain side-impact collisions. Always use safety belts and the correct child restraints for your child's age and size, even in vehicles equipped with air bags. Children are safer when properly secured in a rear seat. See your vehicle Owner's Manual and child safety seat instructions for more information.

GM offers Anti-Lock Brake Systems as standard or optional on all North American passenger vehicles and light truck lines. The computerized Anti-Lock Braking System (ABS) is designed to keep the vehicle's wheels rotating as the brakes are applied to assist the driver in achieving a controlled stop. Sensors monitor how fast the wheels rotate and feed the data continuously to the ABS computer. The vehicle's brakes slow each wheel as the brake pedal is applied. However, when ABS is activated due to road conditions, the system repeatedly releases and applies pressure to the brakes. The wheels can keep rolling, thus retaining steering ability and enhanced stability while providing a higher braking force on most surfaces than a locked wheel provides.

How exactly does ABS work?

In cars without ABS, hitting the brakes can cause the wheels to lock, leaving you unable to steer the vehicle until you decrease the pressure so the wheels can roll again. With an ABS, as you apply the brakes, the ABS computer monitors the wheel speed sensor information. If the computer senses that a wheel is approaching lock up, it sends a signal to the hydraulic modulator to reduce, then to reapply, brake pressure several times a second for as long as you maintain firm pressure on the brake pedal. The process is much like the threshold braking technique used with conventional brakes. However, ABS does it much faster and more accurately than any driver can, leaving you free to focus on steering away from obstacles.

Does ABS reduce stopping distances?

Yes, in braking situations where the wheels on a non-ABS equipped vehicle would lock up, ABS will generally provide shorter controlled stopping distance. The amount of improvement in stopping distance depends on many factors, including the road surface, severity of braking, initial vehicle speed, etc. On some surfaces, such as gravel roads, braking distances can be longer, but you will still have the control benefits of ABS. The important capability of ABS is control. ABS provides improved vehicle steerability and stability when braking.

What can affect the ABS advantage?

It is important that you follow the maintenance schedule recommended in the owner's manual of the vehicle, tires should be at their proper inflation level, the brake pads should be checked regularly, etc. While driving, you should sit comfortably, so that your hips are back in the seat and your knees are bent, even while braking. Your foot should be positioned so that your heel is on the floor and your toes are secure on the lower half of the pedal. And, though ABS may reduce stopping distance, remember: The faster you go, the longer it takes you to stop. Keeping a safe distance between you and the vehicle in front of you is always necessary, even with ABS.

What happens if ABS becomes inactive?

The ABS electronic control unit has on-board diagnostic capability. If a fault is detected, the vehicle will revert to the base brake system, and the ABS telltale on the dash will be illuminated. Should this happen, the vehicle should be taken to a dealership for repair as soon as possible.

How do I use ABS?

Depress and hold the pedal. DO NOT PUMP THE BRAKES (that prevents the system from working). Just hold the brake pedal down and let the ABS work for you. You may feel the brake pedal vibrate, or you may notice some noise, but this is normal as the system works for you.

Should I drive an ABS equipped vehicle differently than I would drive a vehicle with conventional brakes?

Most of the time, under normal driving circumstances, there is no difference, and you should always drive with the same caution and care. It is important to realize that ABS only makes a difference when it is activated—when you have to brake hard—and that would only be when the computer senses that a wheel is approaching lock up. When ABS activates keep steady pressure on the brake pedal and then let the ABS work for you. Don't pump the brakes or try to find the threshold. Simply hold the brake pedal down and steer if necessary to avoid an obstacle.

Is ABS always active?

ABS is always available, but not always activated. ABS is activated only when the brake pedal is applied and the computer detects an impending wheel lock condition.

Can older cars be retrofitted with ABS?

No! The brake system is one of the most important features on any passenger vehicle. Several products, which tap into the master cylinder and/or brake system performance, are being sold in the aftermarket. Some of these products imply performance similar to new vehicle anti-lock brake systems.

However, contrary to their claims, add-on systems, which deplete fluid from the master cylinder on brake apply may actually increase a vehicle's stopping distance. This may cause the vehicle to fail to comply with Federal brake standards.

Does ABS always activate at the same speed?

No, the system operates when the computer detects wheel lockup, at any speed above 8 mph.

Will ABS wear out a vehicle's brakes sooner?

A properly maintained brake system will be unaffected by ABS operation under typical driving conditions.

Are there different types of ABS?

Yes, there are rear wheel anti-lock systems (RWAL) used on some trucks and four-wheel ABS available on cars and trucks.

Do Federal Safety Standards mandate ABS?

No. Federal standards establish minimum braking performance requirements that all vehicles must meet, but do not specify how they should be met. It should be noted that even a vehicle with failed ABS meets the Federal safety standard for stopping distances.

Will a tire size change affect ABS?

Use of tires other than original equipment may affect ABS performance. Owners should consult and follow the recommendations contained in the vehicle owner's manual regarding replacement tire size. *Note: ABS will work with original equipment spare tire or tire chains. However, performance is reduced.*

Do insurance companies give a discount for ABS?

Yes, many insurance companies give discounts that range from 5% to 10%. In the states of New York and Florida all insurance companies are required to give an ABS discount of 5% on certain coverages such as bodily injury, property damage, collision, and personal injury protection. In other states the discount varies from insurance company to insurance company. When buying auto insurance, always ask your insurance agent if his/her company gives a discount for vehicles equipped with anti-lock brakes.



IMPORTANT DRIVING SAFETY TIPS



- A. Always maintain a safe following distance.** ABS does not allow you to stop on a dime. (Generally a 2-second following distance is considered safe in ideal conditions.) Watch the vehicle in front of you pass a fixed marker (such as a sign). Count seconds—one-thousand-one, one-thousand-two—until your front bumper reaches the marker. If you do not count out two seconds, then you are too close to the vehicle in front of you. Also, if the roads are wet or icy, or visibility is poor, you should increase your following distance.
- B. Always drive carefully—** especially on slippery surfaces. ABS cannot create friction between the tires and the road surface, it can only give the driver the maximum advantage of the existing adhesion. If the vehicle is traveling on a surface with no adhesion, the best ABS in the world cannot provide a shorter stopping distance or good steering.
- C. It is a good idea to practice an ABS activated stop** and get the feel of the brake pedal. However, please make sure it's at a safe time with no obstacles in your path. And you only really need to try it once or twice to know what happens.

ELECTRONIC STABILITY CONTROL SYSTEMS (STABILITRAK)

StabiliTrak systems help drivers maintain control of their vehicles, especially during emergency lane changes or avoidance maneuvers. StabiliTrak uses various sensors, such as steering wheel angle, wheel speed, yaw velocity, etc., to detect any difference between the path requested by the steering wheel position and vehicle's actual path. When appropriate, the system selectively controls brakes, engine power, and even suspension settings to enhance control of the vehicle's direction and help keep it on course. Independent studies conducted by the National Highway Traffic Safety Administration, the Insurance Institute for Highway Safety, and others have found StabiliTrak to be highly effective in reducing vehicle crashes. General Motors offers StabiliTrak systems on many of its passenger car and light truck models.

See your owner's manual for additional information about the operation of StabiliTrak.

Q. How do I use StabiliTrak?

A. StabiliTrak operates independently of the driver. You should continue to drive your StabiliTrak equipped vehicle with caution and care. GM's StabiliTrak system, StabiliTrak, is designed to be as seamless as possible in operation, to be part of the overall vehicle response and to make a good vehicle better

Q. How does StabiliTrak work?

A. StabiliTrak has the ability to apply control forces to the vehicle independent of the driver. StabiliTrak uses sensors to continuously compare the path indicated by the steering wheel position to the vehicle's actual path. If a discrepancy is detected, StabiliTrak selectively controls vehicle brakes and engine torque to create a yaw moment that helps restore the vehicle's actual path to the path indicated by the steering wheel position. StabiliTrak has the ability to help correct both understeer (where the vehicle is not turning as much as the steering wheel position indicates) and oversteer (where the vehicle is turning more than the steering wheel position indicates). The illustration at right shows how selective braking at a particular wheel can create a compensating yaw moment to help restore the vehicle's actual path to the path indicated by the steering wheel position.

Q. Will a tire change affect StabiliTrak?

A. Use of tires other than original equipment may affect StabiliTrak performance. StabiliTrak is designed to make the best use of available traction. The performance characteristics of the original equipment tires are part of the overall system effectiveness. When you replace tires check the recommendations in your Owners Manual. On GM vehicles, the original equipment tires have a "TPC" (Tire Performance Criteria) code on the sidewall. Replacing the tires with the same "TPC" code will help assure proper StabiliTrak performance.



Fleet and Commercial

For Information 1-800-FLEET-OP (353-3867)
www.gmfleet.com